

T18MZ

18-CHANNEL COMPUTER SYSTEM



INSTRUCTION MANUAL

Futaba® *Digital Proportional R/C System*

CE0682Ⓢ

1M23N26403

TABLE OF CONTENTS

INTRODUCTION	4	BASIC OPERATION	34
●Support and Service	4	●Battery Charging	34
●Application, Export, and Modification.....	5	●How to turn ON/OFF the transmitter	35
●Definitions of Symbols.....	6	When turning on.....	35
●Safety Precautions (do not operate without reading)	6	When turning off.....	35
		How to reset	36
		●Registration of the user's name.....	36
BEFORE USE	10	●Home screen	37
●Features of 18MZ.....	10	●Home 2 screen	38
●Contents and Technical Specifications.....	12	●User Menu	38
●Accessories.....	13		
●Transmitter controls.....	14	FUNCTIONS OF SYSTEM MENU	39
Cautions on handling antenna	14	Trainer	40
LED monitor	15	Display	43
Switch reallocation (SA-SH)	15	Date & Time.....	44
Volume (LD, CD, RD).....	16	User Name.....	45
Slide Lever (LST, LS, RS, RST).....	16	Switch.....	46
Digital trim (T1-T6).....	17	H/W Setting.....	47
Touch panel / Rotary key / Direct key	17	Sound Volume	49
Stick Adjustment	18	Player	50
Battery exchange.....	19	Camera	51
Back lid	21	S.BUS Servo	52
Connector / Plug.....	22	Information	55
SD card / USB port	23	Range Check	56
Camera function.....	24		
●Receiver R7008SB nomenclature	25	MODEL BASIC SETTING PROCEDURE ...	57
Connector	25	●Airplane/gliders basic setting procedure.....	57
S.BUS2 Connector	25	●Helicopter basic setting procedure.....	59
Link / Mode Switch.....	25	●Receiver and servos connection.....	63
Extra Voltage Connector	25	●Servo connection by model type.....	64
R7008SB CH Mode	26		
●Servo(Optional) / Toolbox.....	27		
●Receiver's Antenna Installation.....	28	FUNCTIONS OF LINKAGE MENU	69
●Safety precautions when installing receiver and servos	29	Servo Monitor	70
●S.BUS Installation.....	30	Model Select	71
●S.BUS Wiring example.....	31	Model Type	72
●S.BUS2 System.....	32	Picture	74
●S.BUS device setting	32	Sound	75
●Telemetry System.....	33	System Type	77
		System Type selection	77
		Receiver linking	77

Dual receiver function	77	Trim Mix 1/2	125
Telemetry function	77	Airbrake	127
D/L Interval	77	Gyro	129
Battery fail-safe voltage setup	77	V-tail.....	130
Linking method (T18MZ ↔ R7008SB).....	78	Ailevator.....	131
The example for choosing System Type.....	79	Winglet.....	132
Function	80	Motor.....	133
Sub-Trim	82	RUD to ELE.....	134
Servo Reverse	83	Snap Roll.....	135
Fail Safe	84	Multi Engine	136
End Point (ATV)	85	Accelerration.....	137
Throttle Cut (Airplane/helicopter only).....	86	•Helicopter Functions	138
Idle Down (Airplane/helicopter only).....	87	PIT Curve	139
Swash Ring (Helicopter only).....	88	THR Curve.....	142
Swash (Helicopter only).....	89	Acceleration	144
Timer	91	Throttle Hold.....	145
Dial Monitor.....	92	Swash Mix.....	146
Function Name	93	Throttle Mix	147
Telemetry.....	94	PIT to Needle	148
Sensor	97	PIT to RUD	149
Warning	99	Gyro	150
Data Reset	100	Governor	151
Codition Hold (Helicopter only).....	101	Throttle Limiter.....	152
<hr/>			
FUNCTIONS OF MODEL MENU	102	<hr/>	
Servo Monitor (Linkage Menu 70)		COMMON OPERATIONS USED IN	
Condition Select.....	103	FUNCTION SETUP SCREEN	
AFR (D/R).....	105	153	
Prog. Mixes	107	<hr/>	
Fuel Mixture.....	109	UPDATING.....	
•Airplane/Glider/EP Glider Functions.....	110	163	
AIL Differential.....	112	<hr/>	
Flap Setting	113	T14MZ →T18MZ MODEL DATA	
AIL to Camber FLP.....	114	CONVERSION	
AIL to Brake FLP.....	115	164	
AIL to RUD.....	116	<hr/>	
Airbrake to ELE.....	117		
RUD to AIL.....	118		
Camber Mix	119		
ELE to Camber.....	121		
Camber FLP to ELE.....	122		
Butterfly	123		

INTRODUCTION

Thank you for purchasing a Futaba® FASSTest-2.4GHz* 18MZ series digital proportional R/C system. This system is extremely versatile and may be used by beginners and pros alike. In order for you to make the best use of your system and to fly safely, please read this manual carefully. If you have any difficulties while using your system, please consult the manual, our online Frequently Asked Questions (on the web pages referenced below), your hobby dealer, or the Futaba Service Center.

Due to unforeseen changes in production procedures, the information contained in this manual is subject to change without notice.

Support and Service: It is recommended to have your Futaba equipment serviced annually during your hobby's "off season" to ensure safe operation.

IN NORTH AMERICA

Please feel free to contact the Futaba Service Center for assistance in operation, use and programming. Please be sure to regularly visit the 18MZ Frequently Asked Questions web site at www.futaba-rc.com/faq/. This page includes extensive programming, use, set up and safety information on the 18MZ radio system and is updated regularly. Any technical updates and US manual corrections will be available on this web page. If you do not find the answers to your questions there, please see the end of our F.A.Q. area for information on contacting us via email for the most rapid and convenient response.

Don't have Internet access? Internet access is available at no charge at most public libraries, schools, and other public resources. We find internet support to be a fabulous reference for many modelers as items can be printed and saved for future reference, and can be accessed at any hour of the day, night, weekend or holiday. If you do not wish to access the internet for information, however, don't worry. Our support teams are available Monday through Friday 8-5 Central time to assist you.

FOR SERVICE ONLY:

Futaba Service Center
3002 N. Apollo Drive, Suite 1
Champaign, IL 61822
Phone: 217-398-0007
www.futaba-rc.com/service.html
Email: service@futaba-rc.com

FOR SUPPORT : (PROGRAMMING AND USER QUESTIONS)

Please start here for answers to most questions:
www.futaba-rc.com/faq/
Fax: 217-398-7721
Phone: 217-398-8970 option 2

OUTSIDE NORTH AMERICA

Please contact your Futaba importer in your region of the world to assist you with any questions, problems or service needs.

Please recognize that all information in this manual, and all support availability, is based upon the systems sold in North America only. Products purchased elsewhere may vary. Always contact your region's support center for assistance.

Application, Export, and Modification

1. This product may be used for model airplane or surface (boat, car, robot) use. It is not intended for use in any application other than the control of models for hobby and recreational purposes. The product is subject to regulations of the Ministry of Radio/Telecommunications and is restricted under Japanese law to such purposes.

2. Exportation precautions:

(a) When this product is exported from the country of manufacture, its use is to be approved by the laws governing the country of destination which govern devices that emit radio frequencies. If this product is then re-exported to other countries, it may be subject to restrictions on such export. Prior approval of the appropriate government authorities may be required. If you have purchased this product from an exporter outside your country, and not the authorized Futaba distributor in your country, please contact the seller immediately to determine if such export regulations have been met.

(b) Use of this product with other than models may be restricted by Export and Trade Control Regulations, and an application for export approval must be submitted. This equipment must not be utilized to operate equipment other than radio controlled models.

3. Modification, adjustment, and replacement of parts: Futaba is not responsible for unauthorized modification, adjustment, and replacement of parts on this product. Any such changes may void the warranty.

Compliance Information Statement (for U.S.A.)

This device, trade name Futaba Corporation of America, model number R7008SB, complies with part 15 of the FCC Rules. Operation is subject to the following two conditions:

- (1) This device may not cause harmful interference, and
- (2) This device must accept any interference received, including interference that may cause undesired operation.

The responsible party of this device compliance is:

Futaba Service Center

3002 N Apollo Drive Suite 1, Champaign, IL 61822 U.S.A.

TEL (217)398-8970 or E-mail: support@futaba-rc.com (Support)

TEL (217)398-0007 or E-mail: service@futaba-rc.com (Service)



(for USA)

The RBRC. SEAL on the nickel-cadmium battery contained in Futaba products indicates that Futaba Corporation of America is voluntarily participating in an industry-wide program to collect and recycle these batteries at the end of their useful lives, when taken out of service within the United States. The RBRC. program provides a convenient alternative to placing used nickel-cadmium batteries into the trash or municipal waste system, which is illegal in some areas.

You may contact your local recycling center for information on where to return the spent battery. Please call 1-800-8BATTERY for information on Ni-Cd battery recycling in your area. Futaba Corporation of America's involvement in this program is part of its commitment to protecting our environment and conserving natural resources.

*RBRC is a trademark of the Rechargeable Battery Recycling Corporation.

Federal Communications Commission Interference Statement (for U.S.A.)

This equipment has been tested and found to comply with the limits for a Class B digital device, pursuant to Part 15 of the FCC Rules. These limits are designed to provide reasonable protection against harmful interference in a residential installation.

This equipment generates, uses and can radiate radio frequency energy and, if not installed and used in accordance with the instructions, may cause harmful interference to radio communications. However, there is no guarantee that interference will not occur in a particular installation. If this equipment does cause harmful interference to radio or television reception, which can be determined by turning the equipment off and on, the user is encouraged to try to correct the interference by one or more of the following measures:

- Reorient or relocate the receiving antenna.
- Increase the separation between the equipment and receiver.
- Connect the equipment into an outlet on a circuit different from that to which the receiver is connected.
- Consult the dealer or an experienced radio/TV technician for help.

CAUTION:

To assure continued FCC compliance:

Any changes or modifications not expressly approved by the grantee of this device could void the user's authority to operate the equipment.

Exposure to Radio Frequency Radiation

To comply with FCC RF exposure compliance requirements, a separation distance of at least 20cm must be maintained between the antenna of this device and all persons.

This device must not be co-located or operating in conjunction with any other antenna or transmitter.

Meaning of Special Markings

Pay special attention to safety where indicated by the following marks:

- ⚠ **DANGER** - Procedures which may lead to dangerous conditions and cause death/serious injury if not carried out properly.
- ⚠ **WARNING** - Procedures which may lead to a dangerous condition or cause death or serious injury to the user if not carried out properly, or procedures where the probability of superficial injury or physical damage is high.
- ⚠ **CAUTION** - Procedures where the possibility of serious injury to the user is small, but there is a danger of injury, or physical damage, if not carried out properly.

⊘ = Prohibited ⚠ = Mandatory

Warning: Always keep electrical components away from small children.

FLYING SAFETY

⚠ WARNING

To ensure the safety of yourself and others, please observe the following precautions:

- ⚠ **Have regular maintenance performed.** Although your 18MZ protects the model memories with non-volatile EEPROM memory (which does not require periodic replacement) and not a battery, the transmitter still should have regular checkups for wear and tear. We recommend sending your system to the Futaba Service Center annually during your non-flying-season for a complete checkup and service.

Battery

- ❗ **Charge the batteries!** (See Charging the batteries, for details.) Always recharge the transmitter and receiver batteries before each flying session. A low battery will soon die potentially, causing loss of control and a crash. When you begin your flying session, reset your T18MZ's built-in timer, and during the session pay attention to the duration of usage.
- ❗ **Stop flying long before your batteries become low on charge. Do not rely on your radio's low battery warning systems, intended only as a precaution, to tell you when to recharge. Always check your transmitter and receiver batteries prior to each flight.**

Where to Fly

We recommend that you fly at a recognized model airplane flying field. You can find model clubs and fields by asking your nearest hobby dealer, or in the US by contacting the Academy of Model Aeronautics.

You can also contact the national Academy of Model Aeronautics (AMA), which has more than 2,500 chartered clubs across the country. Through any one of them, instructor training programs and insured newcomer training are available. Contact the AMA at the address or toll-free phone number below.

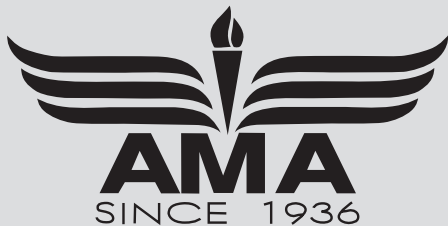

Academy of Model Aeronautics

5161 East Memorial Drive

Muncie, IN 47302

Tele. (800) 435-9262

Fax (765) 289-4248

or via the Internet at <http://www.modelaircraft.org>

- ❗ **Always pay particular attention to the flying field's rules,** as well as the presence and location of spectators, the wind direction, and any obstacles on the field. Be very careful flying in areas near power lines, tall buildings, or communication facilities as there may be radio interference in their vicinity.

Lithium polymer(Li-po) Battery Safety and Handling instructions

IMPORTANT!

Use only the **Futaba special charger** included with this set or other chargers approved by Futaba to charge the Li-po batteries in the T18MZ transmitter included with this set.

It is important to understand the operating characteristics of Li-po batteries. Always read the specifications printed on the label of your Li-po battery and charger prior to use. Failure to follow the proceeding precautions can quickly result in severe, permanent damage to the batteries and its surroundings and possibly result in a **FIRE!**

IMPORTANT PRECAUTIONS

- ⊗ Do not attempt to disassemble Li-po packs or cells.
- ⊗ Do not allow Li-po cells to come in contact with moisture or water at any time.
- ❗ Always provide adequate ventilation around Li-po batteries during charge, discharge, while in use, and during storage.
- ⊗ Do not leave a Li-po battery unattended at any time while being charged or discharged.
- ⊗ Do not attempt to charge Li-po batteries with a charger that is NOT designed for Li-po batteries, as permanent damage to the battery and charger could result.
- ❗ Always charge Li-po batteries in a fireproof location. Do not charge or discharge Li-po batteries on carpet, a cluttered workbench, near paper, plastic, vinyl, leather or wood, or inside an R/C model or full-sized automobile! Monitor the charge area with a smoke or fire alarm.
- ⊗ Do not charge Li-po batteries at currents greater than the “1C” rating of the battery (“C” equals the rated capacity of the battery).
- ⊗ Do not allow Li-po cells to overheat at any time! Cells which reach greater than 140 degrees Fahrenheit (60°C) should be placed in a fireproof location.
- ❗ Li-po cells will not charge fully when too cold or show full charge.
- ❗ It is normal for the batteries to become warm during charging, but if the charger or battery becomes excessively hot disconnect the battery from the charger immediately!! Always inspect a battery which has previously overheated for potential damage, and do not re-use if you suspect it has been damaged in any way.
- ⊗ Do not use a Li-po battery if you suspect physical damage has occurred to the pack. Carefully inspect the battery for even the smallest of dents, cracks, splits, punctures or damage to the wiring and connectors. DO NOT allow the battery’s internal electrolyte to get into eyes or on skin—wash affected areas immediately if they come in contact with the electrolyte. If in doubt, place the battery in a fire-proof location for at least 30 minutes.
- ⊗ Do not store batteries near an open flame or heater.
- ⊗ Do not discharge Li-po batteries at currents which exceed the discharge current rating of the battery.
- ❗ Always store Li-po cells/packs in a secure location away from children.

Secure Digital (SD) Memory Card Handling Instructions (SD card is not included with this set)

- ⊗ Never remove the SD card or turn off power while entering data.
- ⊗ Never store the SD card where it may be subject to strong static electricity or magnetic fields.
- ⊗ Do not expose the SD card to direct sunlight, excessive humidity or corrosive environments.
- ⊗ Do not expose the SD card to dirt, moisture, water or fluids of any kind.
- ❗ Be certain to insert the SD card in the correct direction.

At the flying field

To prevent possible damage to your radio gear, turn the power switches on and off in the proper sequence:

1. Pull throttle stick to idle position, or otherwise disarm your motor/engine.
2. Turn on the transmitter power and allow your transmitter to reach its home screen.
3. Confirm the proper model memory has been selected.
4. Turn on your receiver power.
5. Test all controls. If a servo operates abnormally, don't attempt to fly until you determine the cause of the problem.
Test to ensure that the FailSafe settings are correct after adjusting them. Turn the transmitter off and confirm the proper surface/throttle movements. Turn the transmitter back on.
6. Start your engine.
7. Complete a full range check.
8. After flying, bring your throttle stick to idle position, engage any kill switches or otherwise disarm your motor/engine.
9. Turn off receiver power.
10. Turn off transmitter power.

If you do not turn on your system in this order, you may damage your servos or control surfaces, flood your engine, or in the case of electric-powered or gasoline-powered models, the engine may unexpectedly turn on and cause a severe injury.

- ❗ **While you are getting ready to fly, if you place your transmitter on the ground, be sure that the wind won't tip it over. If it is knocked over,** the throttle stick may be accidentally moved, causing the engine to speed up. Also, damage to your transmitter may occur.
- ❗ In order to maintain complete control of your aircraft it is important that **it remains visible at all times.** Flying behind large objects such as buildings, grain bins, etc. is not suggested. Doing so may result in the reduction of the quality of the radio frequency link to the model.
- ⊘ **Do not grasp the transmitter's antenna during flight.** Doing so may degrade the quality of the radio frequency transmission.
- ❗ As with all radio frequency transmissions, the strongest area of signal transmission is from the sides of the transmitter's antenna. As such, the antenna should not be pointed directly at the model. If your flying style creates this situation, easily move the antenna to correct this situation.
- ⊘ As with all radio frequency transmissions, the strongest area of signal transmission is from the sides of the transmitter's antenna. As such, the antenna should not be pointed directly at the model. If your flying style creates this situation, easily move the antenna to correct this situation.

BEFORE USE

FEATURES

FASSTest system

The T18MZ transmitter adopted the newly developed bidirectional communication system "FASSTest". Data from the receiver can be checked in your transmitter. FASSTest is a maximum 18 channels (linear 16 channels + switch 2 channels) 2.4GHz dedicated system.

S.BUS2 system

By using the S.BUS2 system multiple servos, gyros and telemetry sensors are easily installed with a minimum amount of cables.

Windows CE

T18MZ utilizes the world famous Microsoft Windows CE, which offers outstanding dependability and valuable resources.

Color LCD

T18MZ has a HVGA (640x240 pixels) full color Backlight LCD touchscreen. The screen is manufactured of a transfective construction which enables both indoor and outdoor visibility.

Music Play

T18MZ can playback WMA (Windows Media Audio) files on a SD-Card. You can enjoy music by the internal speaker or stereo headphones from the earphone jack. A switch can be assigned to start/stop your music.

Voice Recording

You can record your own voice using the internal microphone and then play back commands assigned to certain switches. Recording time is 3 seconds maximum and 24 voice files can be stored.

Camera function + picture paste function

The transmitter has a 0.03M megapixels digital camera function. Picture files can be inserted as pictures of each model, and shown on the home screen. Identification during model selection is easy and convenient. (File type: bmp, JPEG, picture size: 158x80 pixels)

Secure Data (SD)

Model data, music files, voice files and picture files can be stored on optional SD card. The SD card is also used when updating the software/features of the T18MZ.

High capacity lithium polymer battery (3500mAH)

The high capacity Lithium Polymer battery gives you extended flight time.

USB connection

A USB connector is built in. A commercial PC mouse and keyboard can be used. The model data can also be stored in a USB memory flash drive.

Editing

The touch panel and rotary encoder editing system allows you to edit your model in the manner that is easiest for you.

Functions

The internal dual processors operate the many 18MZ functions and optimize the response time. Most of the mixing functions are operated by curves which give you very precise settings.

Stick

Each axis is supported by dual ball bearings. This allows for finer and more precise operation, the new potentiometers also offer a very long lifespan.

Replaceable switches

You can replace 8 of the toggle switches on the right and left shoulder, with optional switches (two position, three position, and momentary etc.).

Vibration function

Low voltage and other alarms are generated by a vibration motor. Alarms or vibrations to be used can be selected by the owner.

R7008SB

The system comes with the R7008SB S.BUS2 Dual Antenna Diversity receiver featuring bi-directional communication.

Contents and Technical Specifications

(Specifications and ratings are subject to change without notice.)

Your 18MZ (packaged with a S.BUS receiver) includes the following components:

- T18MZ Transmitter
- R7008SB Receiver
- LT2F3500XH Lithium-polymer battery & AC adaptor
- Switch harness
- Tool Box (includes special jig for adjustment)
- Neck strap
- Transmitter case

The set contents depend on the type of set.

Transmitter T18MZ

Operating system: 2-stick, 18 channels, 2.4GHz
FASSTest /FASST/S-FHSS system

Transmitting frequency: 2.4 GHz

Power supply: 7.4V LT2F3500 Li-polymer battery

Current drain: 1 ampere maximum (RF power on and
back light on) 700mA average

Receiver R7008SB

(FASSTest, S.BUS2, Diversity)

Receiving frequency: 2.4 GHz FASSTest system

Power requirement: 6.6 V Li-Fe battery

Current drain: 75 mA

Size: 24.9x47.3x14.3 mm

Weight: 10.9 g.

The following additional accessories are available from your dealer. Refer to a Futaba catalog for more information:

- LT2F3500XH Transmitter battery pack - the (3500mAh) transmitter Lithium-polymer battery pack may be easily exchanged with a fresh one to provide enough capacity for extended flying sessions.
- Trainer cord - the optional training cord may be used to help a beginning pilot learn to fly easily by placing the instructor on a separate transmitter. Note that the T18MZ transmitter may be connected to another T18MZ system, as well as to any other models of Futaba transmitters. The T18MZ transmitter uses the newer “Micro” rectangular type cord plug. Both Micro- to-Micro and Micro-to-round plug style trainer cords are available.
- Neckstrap - a neckstrap may be connected to your T18MZ system to make it easier to handle and improve your flying precision since your hands won't need to support the transmitter's weight.
- Y-harnesses, servo extensions, etc - Genuine Futaba extensions and Y-harnesses, including a heavy-duty version with heavier wire, are available to aid in your larger model and other installations.
- Gyros - a variety of genuine Futaba gyros are available for your aircraft or helicopter needs.
- Governor - for helicopter use. Automatically adjusts throttle servo position to maintain a constant head speed regardless of blade pitch, load, weather, etc.
- Receivers - various models of Futaba receivers may be purchased for use in other models. (Receivers for 2.4GHz types are available.)
- Servos - there are various kinds of servos. Please choose from the servos of Futaba what suited the model and the purpose of using you.

Transmitter controls

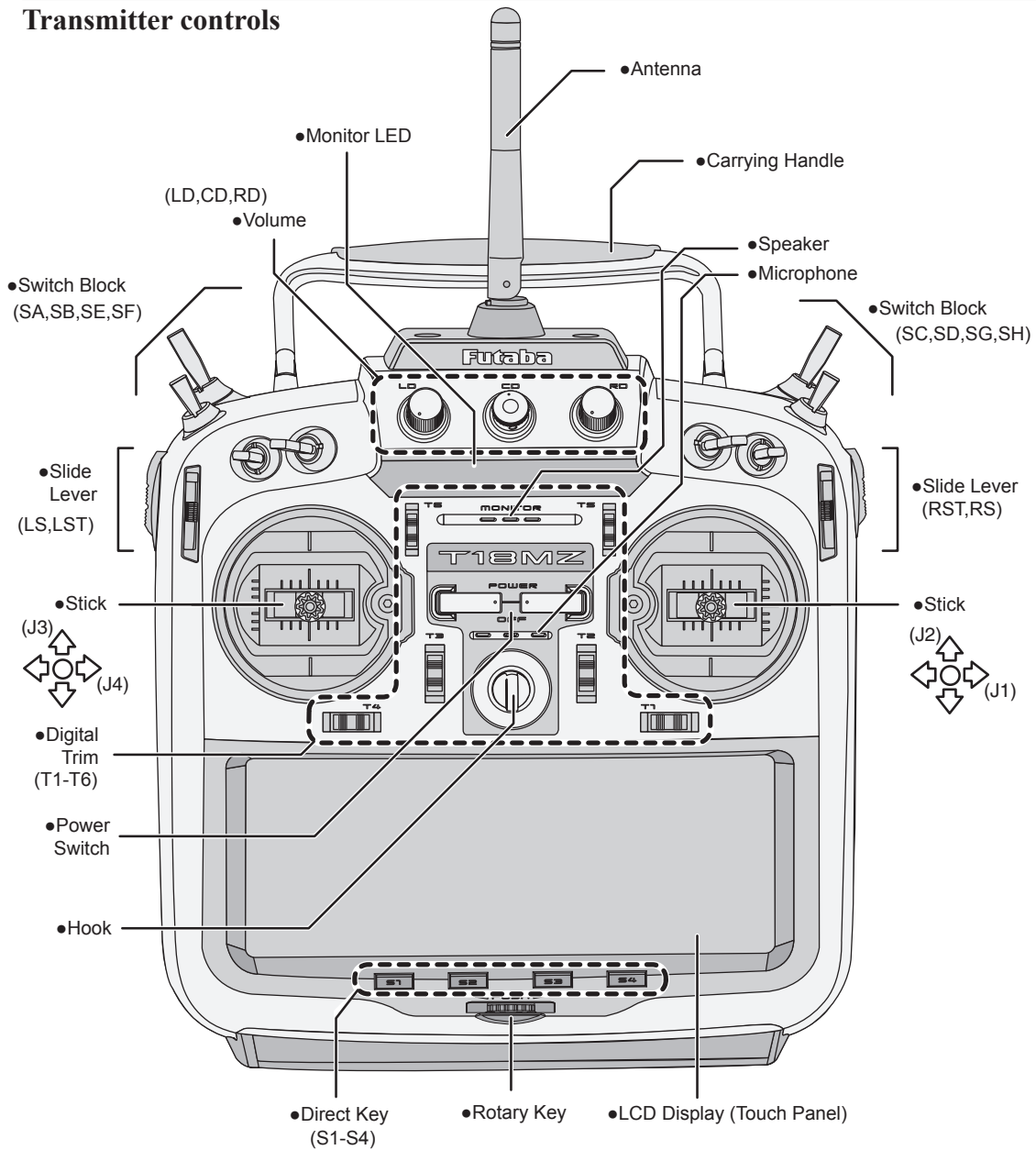

Cautions on handling antenna

⚠ WARNING

- ⊘ Do not touch the antenna during operation.
*There is the danger of erroneous operation causing a crash.
- ⊘ Do not carry the transmitter by the antenna.
*There is the danger that the antenna wire will break and operation will become impossible.
- ⊘ Do not pull the antenna forcefully.
*There is the danger that the antenna wire will break and operation will become impossible.

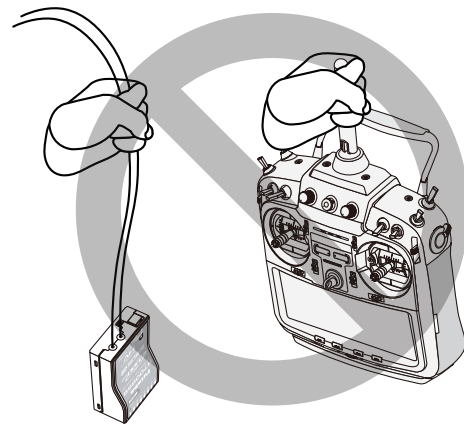

•Rotating antenna

The antenna can be rotated 90 degrees and angled 90 degrees. Forcing the antenna further than this can damage it. The antenna is not removable.

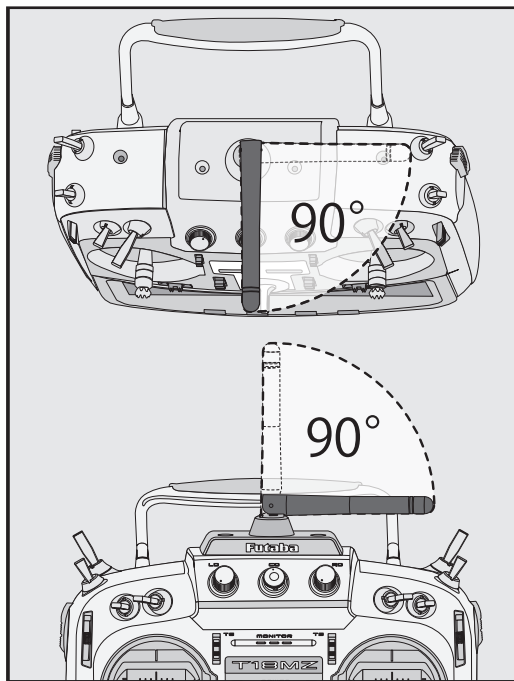

•Angle adjustment of the antenna

The antenna rotation and angle can be adjusted. The antenna features weak radio waves in the forward direction and strong radio waves in the sideways directions. Adjust the antenna angle to match your flying style.

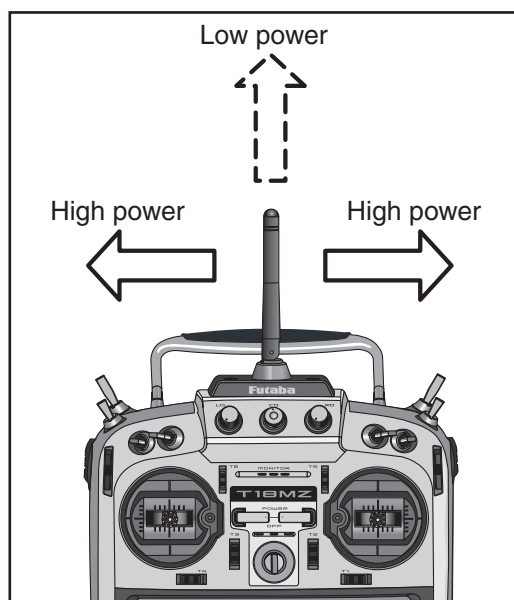

LED monitor

The status of the transmitter is displayed by changing the "MONITOR" section LED.

(LED Display)

- FASSTest mode → Light Blue light
- FASST mode → Green light
- S-FHSS mode → yellow-green light
- RF-OFF → Violet light
- Starting → Red light
- Trainer Student → Blue light

Switch reallocation

You can reallocate the toggle switches on the shoulders of the transmitter, as you like.

(Default settings)

- SA : 3 positions; Alternate; Short lever
- SB : 3 positions; Alternate; Long lever
- SC : 3 positions; Alternate; Long lever
- SD : 3 positions; Alternate; Short lever
- SE : 3 positions; Alternate; Short lever
- SF : 2 positions; Alternate; Long lever
- SG : 2 positions; Alternate; Short lever
- SH : 2 positions; Momentary; Long lever

*You can choose the Switch and the On/Off position in the Switch Selection menu of your mix.

•When you change switches:

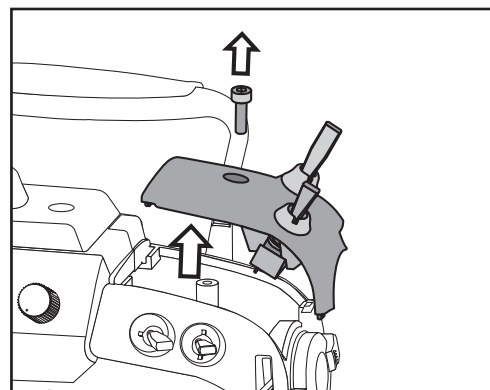

To relocate switches;

1. Make sure your transmitter is off, and use the attached 2.5mm hexagonal wrench (included) to turn the screw counter-clockwise on the switch block and detach the block. Remove the screw holding the switch block. Pull up on the switch block to remove it.
2. Disconnect the connectors of switches you want to change.

3. Use the attached jig (inside stylus) to turn the face nuts counterclockwise, this will detach the switches.
4. To re-attach, use the face nuts to attach switches from other positions or optional switches to the switch block.
5. Connect your connectors.
6. Insert the switch block so reconnect the connectors that it fits correctly into the body of the transmitter (as shown in the picture) and use the hexagonal wrench to tighten the screws.

Volume

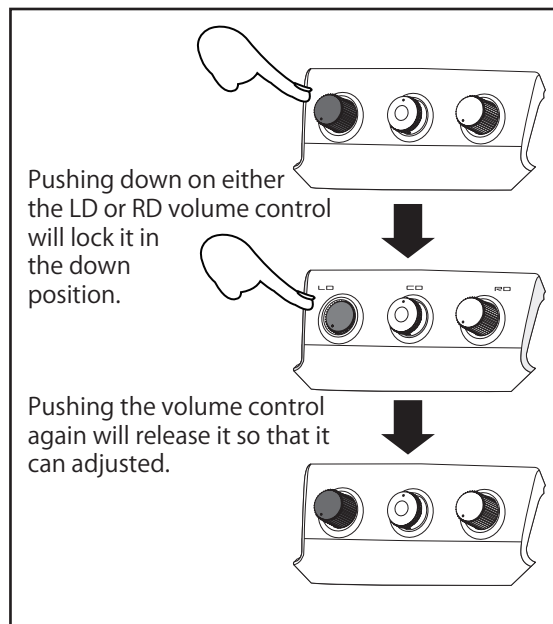

Volume LD, CD, and RD:

If you push the volume button in, it will be locked in place. To release the volume button, push it in lightly once more.

This volume is digital type (rotary encoder). This volume works as both a volume and a push-switch.

- *T18MZ beeps when the volume knob reaches center.
- *You can check the volume position on the Dial Monitor screen in the Linkage menu.
- *You can use each setting screen of the mixing functions to select volumes and define the direction of its movement.

Slide Lever

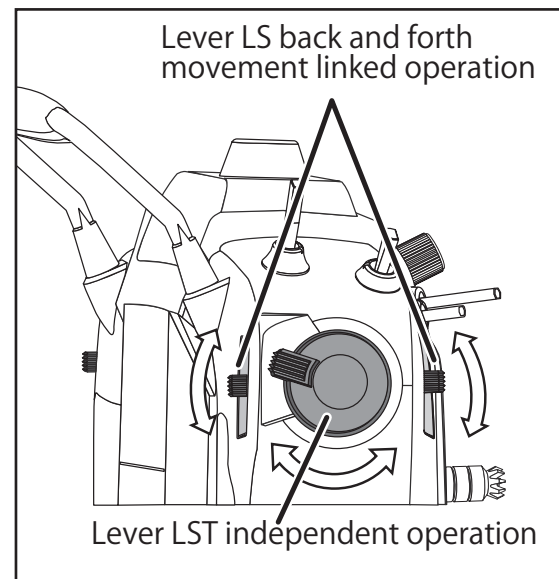

LST (Left), RST (right):

Outside levers

LS (Left), RS (right):

Inside levers: Each lever has two ends, one at the front and the other at the back of the transmitter.

- *It will beep when the lever is set to the center.
- *You can check the lever position on the dial-monitor screen in the linkage menu.
- *You can select a slide lever and set the movement direction on the setting screen of mixing functions.

Digital trim

This transmitter is equipped with digital trims. Each time you press a trim button, the trim position moves one step. If you continue pressing it, the trim position starts to move faster. In addition, when the trim position returns to the center, the tone will change. You can always monitor trim positions graphics on the screen. To change the trim rate, you must activate this through the function menu, within the linkage menu. Touch the trim button and you will access another screen which enables you to change the trim percentages.

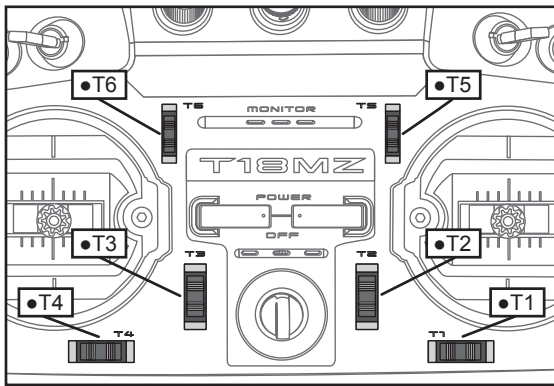

Note: The trim positions you have set will be stored in the non-volatile memory and will remain there.

Touch Panel/ Rotary Key/ Direct Key

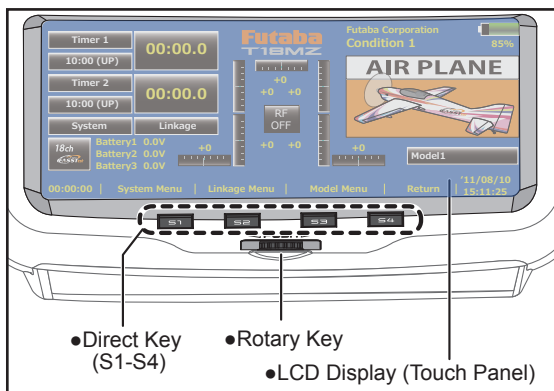

Touch panel, rotary keys and direct keys are used for entering data.

Touch Panel

Touch the panel with your finger or the attached stylus pen, which is also used as a toolbox, to enter data.

⚠ Caution

! Touch softly the Touch Panel with the stylus pen or your fingertips.

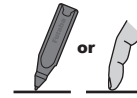

*Plastic film is attached to the touch panel. Please be careful so that you don't scratch the touch panel with anything hard such as a metal object. Don't push the touch panel with excessive force or drop anything on the panel.

*Although you may find some air bubbles under the plastic panel due to environmental changes such as temperature, it is not a defect and will cause no problems.

Rotary key

In addition to touch panel, you can select items by rotating the rotary keys to the left or to the right.

*There is a function which cannot be accessed by the Rotary Key.

Direct key

You can directly call your favorite functions or menu screens.

(The default setting at the factory)

- S1: System menu
- S2: Linkage menu
- S3: Model menu
- S4: Return

[How to change assignment of the direct key]

1. Open the screen you want to call. Then push S1 and S4 keys simultaneously. (You will see the direct key setting screen.)
2. Select the direct key.
3. The [Enter] key is pressed.
4. The [Yes] key is pressed.

⚠ Danger

! The T18MZ's touch screen is very sensitive. To avoid accidentally activating it during a flight, it is suggested that it be locked. Due to the new sensitive type touch screen, if a neck strap hook, servo extension, or even your hand during a flight touches the screen, it could be dangerous. Please use the touch panel lock for added safety during flight.

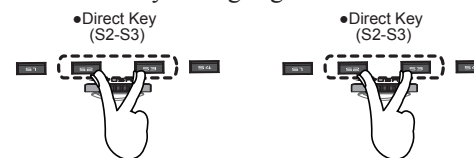

The **touch panel locked** by S2 and S3 pushed.

The **touch panel unlocked** by S2 and S3 pushed again.

Locking the LCD touch screen.

* Maintain a touch-panel lock irrespective of ON/OFF of a transmitter.

Stick Adjustment

Adjustment of the stick lever angle

You can make fine adjustments to the angle of a stick lever either inwards or outwards from the center stick position.

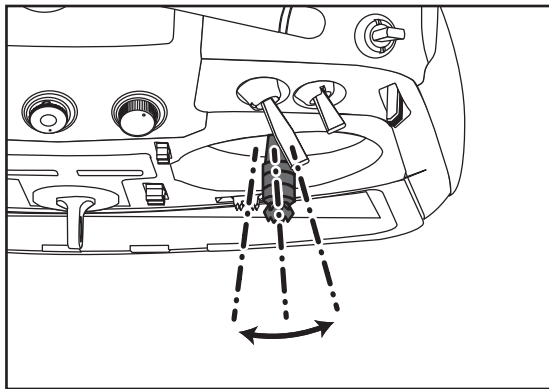
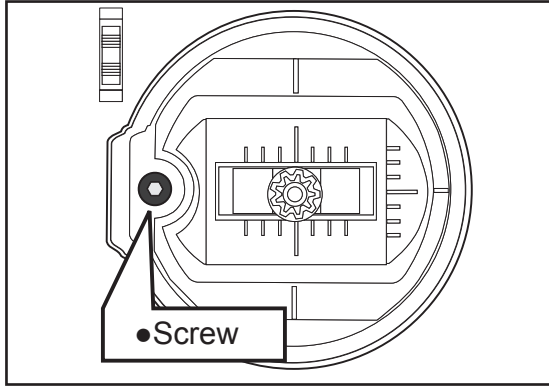

Use the attached 1.5mm hexagonal wrench (inside stylus) to turn the screw clockwise to adjust the stick outwards, or counter-clockwise to tilt it inward.

Note: Be careful not to turn the screw too far counterclockwise as it could fall out.

Adjustment of the lever length

You can adjust the length of stick levers, as you like. It is recommended to adjust the length of the sticks in line with your hand size.

[How to adjust the Stick length.]

1. Hold the lever head "B" and turn the lever head "A" counter-clockwise, the lock will be released.
2. Adjust the stick lever to the desired length by turning lever head A.

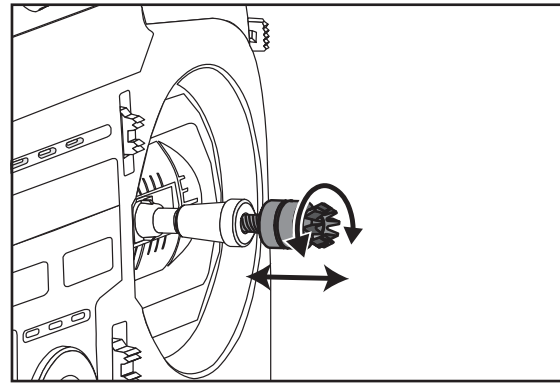

3. Securely lock the stick lever by holding lever head A and turning lever head B counterclockwise.

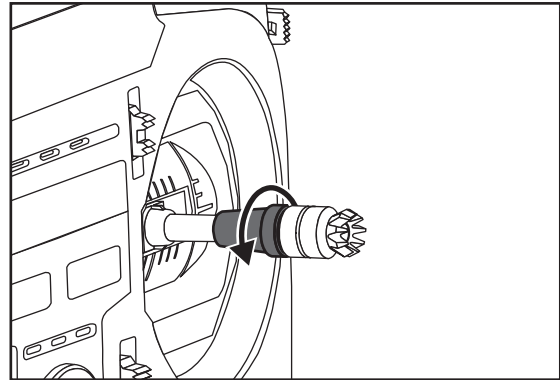

Adjustment of Stick Lever Tension

You can adjust the tension of stick-levers.

The rubber cover in the back is removed first.

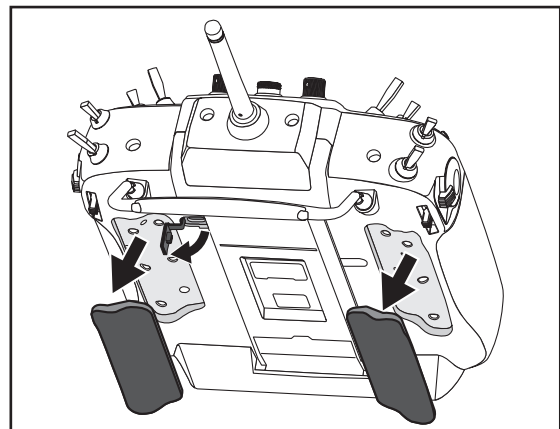

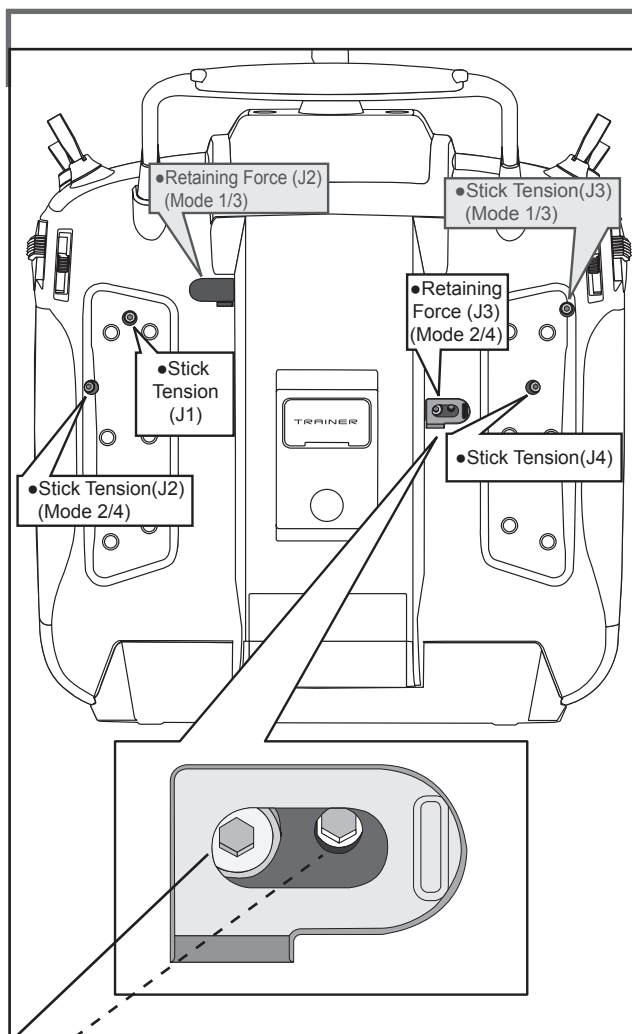

*In the Mode 1/3, arrangement of a screw is opposite.

[Adjustment of tension]

Adjustment of Throttle Stick (Ratchet System)

You can choose either airplane ratchet system or helicopter-touch.

1. Open the dust protection cap on the back of the transmitter that is covering the hole for throttle stick adjustment.
2. Use the attached 1.5mm hexagonal wrench (inside stylus) to turn the adjustment screw and set it as you prefer. Turning the screw clockwise increases the tension.

For airplanes: Adjust the screw on the left.

For helicopters: Adjust the screw on the right.

In changing the setting from airplane to helicopter (or heli to airplane);

1. Turn the screw counter-clockwise until the throttle stick moves freely, and turn the screw clockwise to adjust it to the tension you prefer.

*This transmitter has two ratchet plates, one for airplane and the other one for helicopter. If you tighten both screws, you won't be able to achieve the adjustment that you need because of the overlap of those two adjustments.

*If you want to change the setting from airplane to helicopter (or from helicopter to airplane), turn the ratchet screw clockwise until the throttle stick moves freely. Then turn the screw for the helicopter until you get the tension you like.

Battery exchange

Note: Detaching the battery while the power is on can cause data you have recently edited to be lost.

[How to remove battery LT2F3500XH]

1. Using the tabs at the side of the transmitter, open the side door to the rear as shown in the figure.

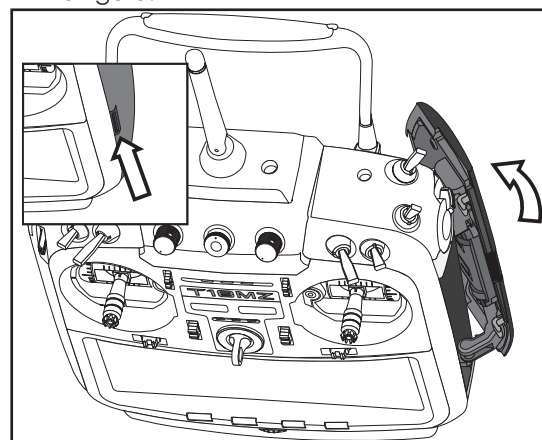

2. Open the battery cover inside the transmitter by sliding it upward as shown in the figure.

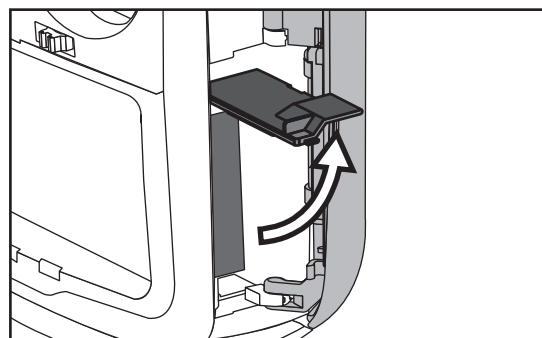
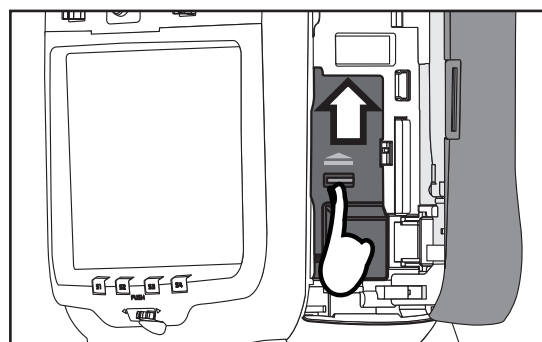

3. Pull up on the lip of the black "connector slider" to remove the battery connector.

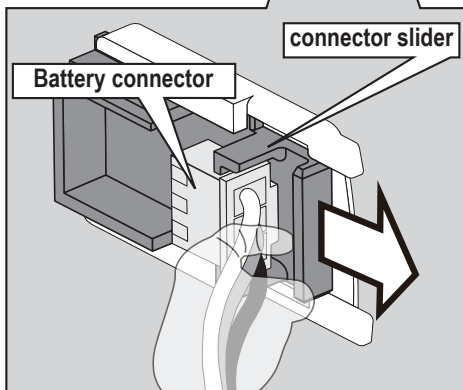
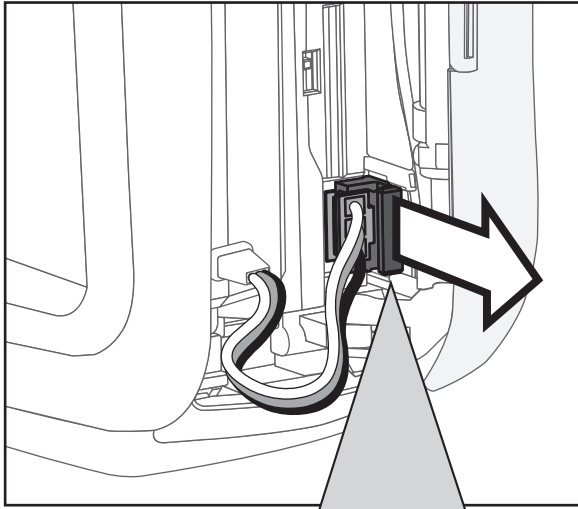

*Remove the connector by pulling up on the lip of the slider, not the wiring.

[How to install battery LT2F3500XH]

1. Insert the battery into the transmitter.

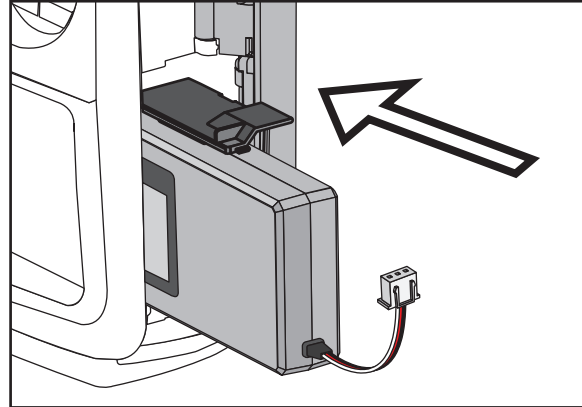

2. Insert the battery with the battery connector facing the direction shown in the figure. (Push the battery housing, not the battery wiring.)

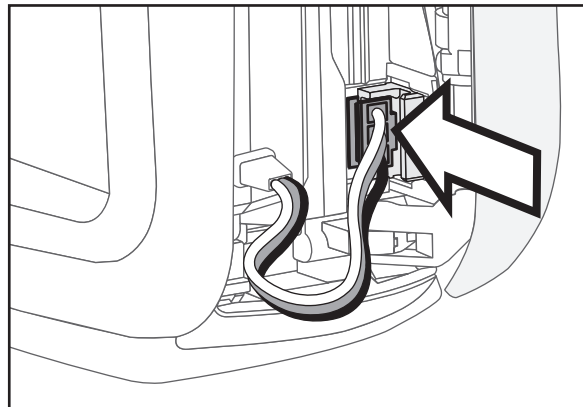

4. Pull out the battery.

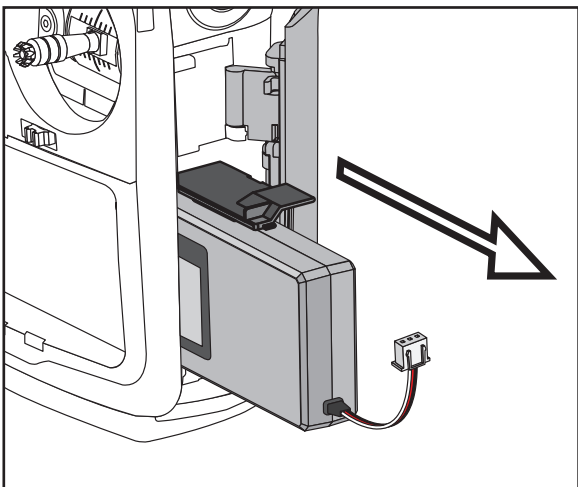

3. Arrange the battery wiring as shown in the figure.

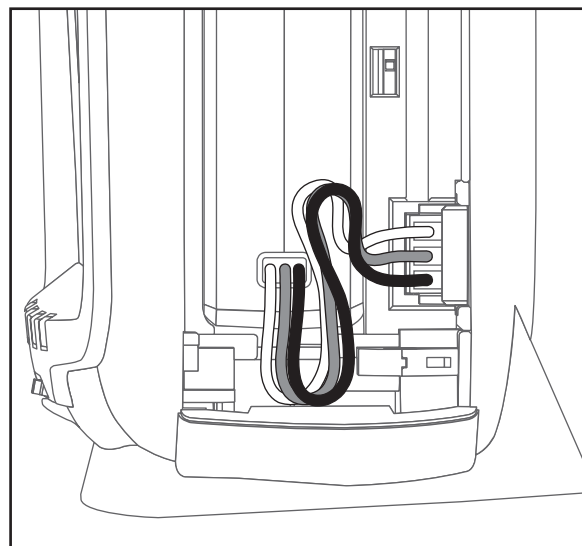

4. Close the battery cover so that the wiring is not pinched and lock the cover by pushing downward.

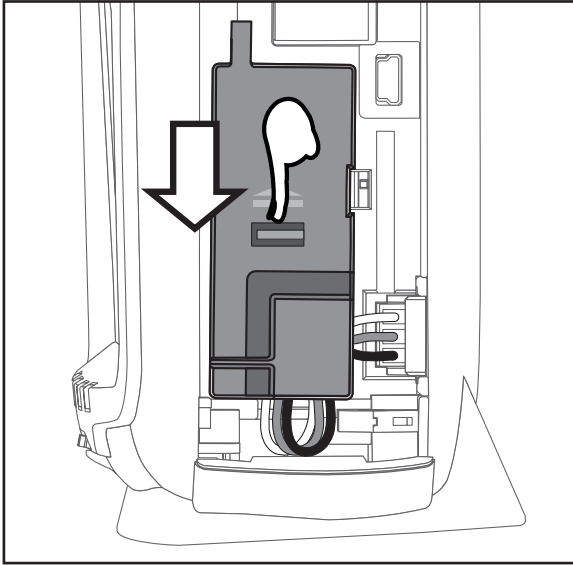

5. Close the side door.

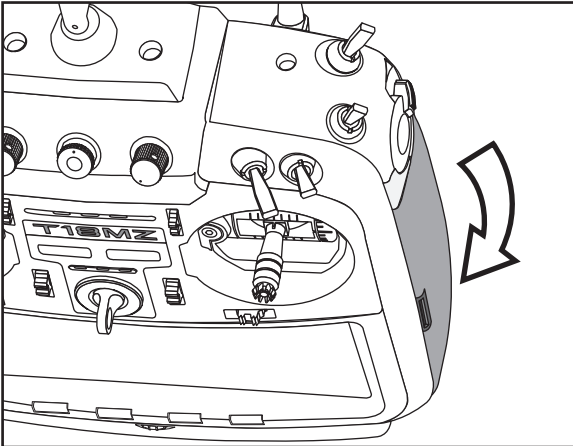

⚠ Warning

- ❗ Be careful not to drop the battery.
- ⊘ Never take out the battery from the T18MZ transmitter while the LED monitor is blinking.
 - * Internal settings and memories can be destroyed.
 - * Do not use the transmitter if a "Backup Error" warning occurs. Send it to the Futaba Service Center to be checked.
- ⊘ Don't pull battery wiring.
 - *When it short-circuits, there is danger of explosion ignition.

Back lid

The charging connector, earphone jack, and S.BUS setting connector, charge LED are accessed by opening the transmitter rear cover as shown in the figure.

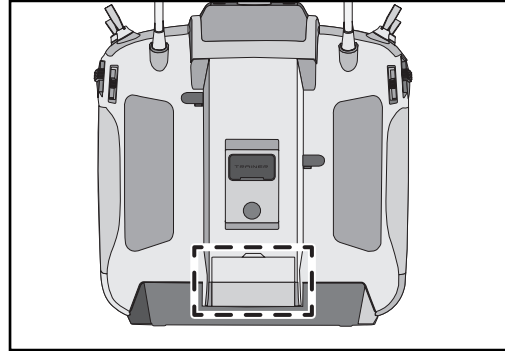

[How to open back lid.]

1. Open the transmitter rear cover as shown in the figure.

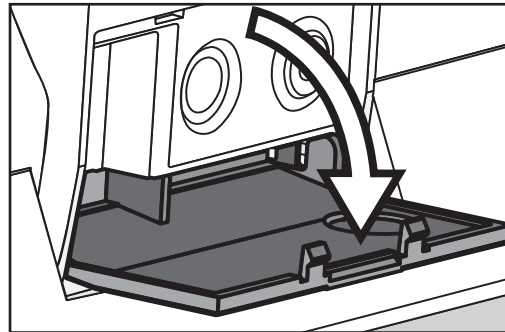
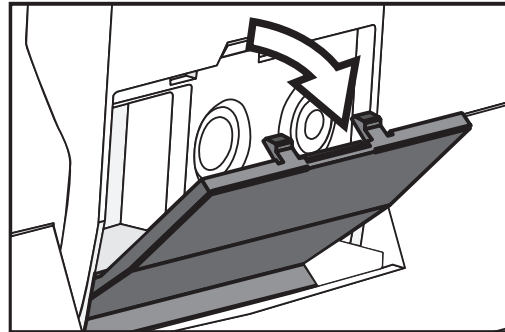

2. House the rear cover by pushing it into the transmitter.

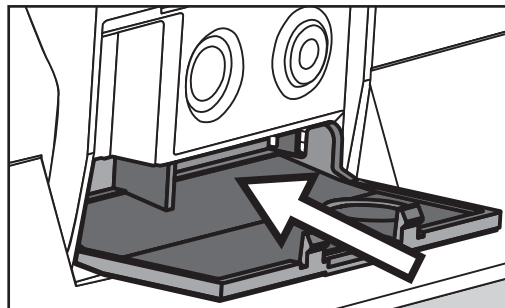

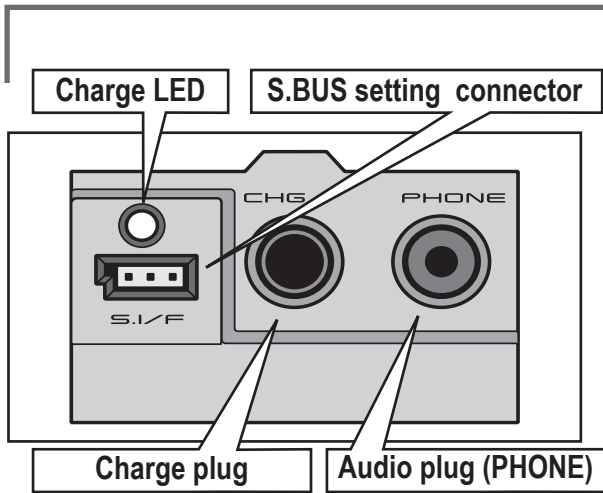

3. When not using the connector, pull out and close the rear cover.

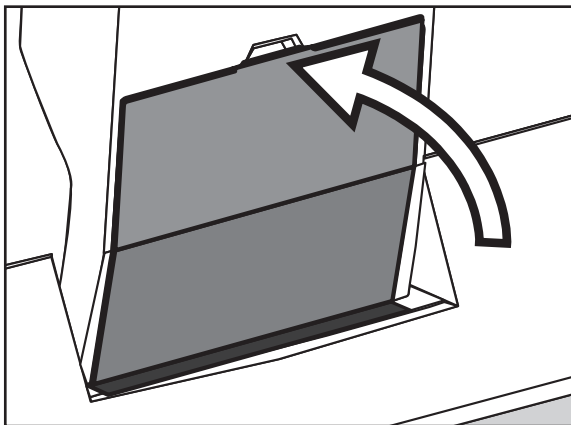
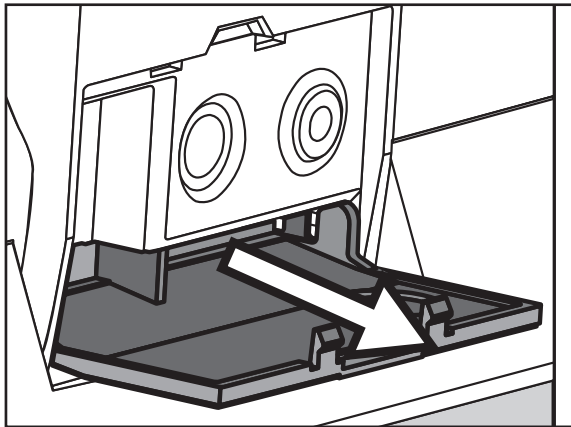

Connector/Plug

1. The back of transmitter.

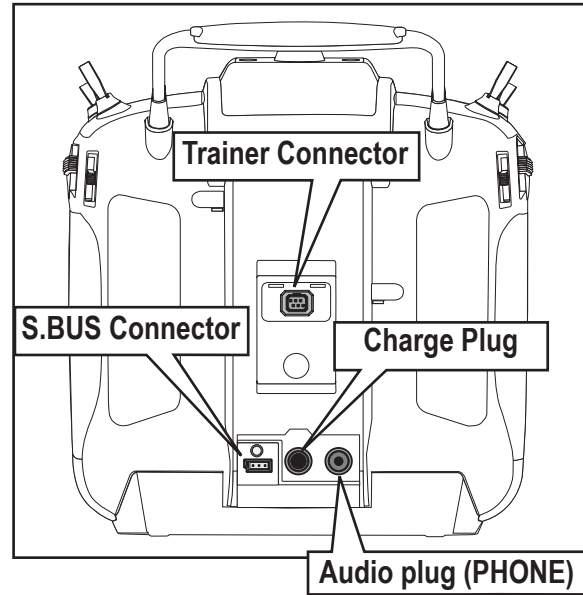

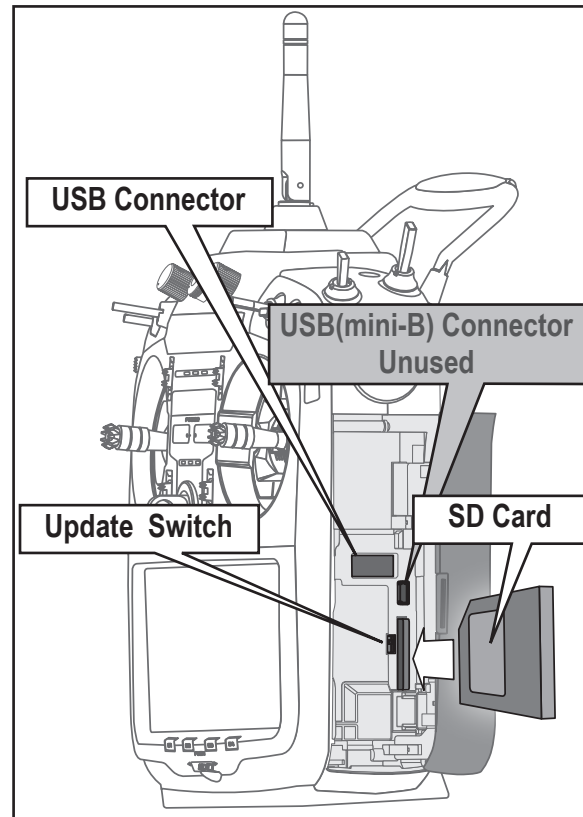

2. Inside of transmitter of side cover



SD Card (sold separately)

The SD card can store various files, such as model data, music, sound files and pictures. Any SD card on the market can be used with the T18MZ. The card is locked when it is pushed in all the way in. To remove the card, push in on the card again, it will pop up allowing you to remove it.

Warning

-  Be sure to turn off the power to the transmitter before inserting or removing the SD card.
-  As the SD card is a precision device, do not use excessive force when inserting.
-  If model data generated by a new software version transmitter is copied to an old software version transmitter, the transmitter may operate erroneously. Copy the model data after updating the copy destination transmitter to the new software version.

Read data from a PC

Saving music and image files edited by a PC into the SD card, you can use those files on your T18MZ transmitter. Equipment for reading and writing SD cards are available at most electronics stores.

Stored data

The life of the SD card is limited due to the use of Flash memory. If you have a problem saving or reading data such as picture data after a long period of use you may need to purchase a new SD card.

*We are not responsible for, and cannot compensate for any failure to the data stored in the memory card for any reason. Be sure to keep a backup of your models and data in your SD card.

***No necessity for backup;** T18MZ transmitters and SD cards are using nonvolatile memory devices so that the data stored in those will not be destroyed even without a backup battery. The clock for the transmitter depends on the Lithium battery.

Update Switch

When using an SD card to update the T18MZ software, set this switch to the up position. Then input the software to be updated to the SD card from the Futaba importers homepage and update the software in accordance with the updating procedure.

USB port

The following functions can be used with USB connector.

- USB Mouse
When a mouse is connected, a cursor will appear on the screen and the mouse can be used instead of the touch panel.
- USB Keyboard
When a keyboard is connected, the model name and other data can be input by keyboard.
- USB Memory
All model data, etc. can be saved to an optional USB Memory stick.

Connector for trainer function (TRAINER)

When you use trainer function, connect the optional trainer cable between the transmitters for teacher and student.

*You can set the trainer function on the Trainer Function screen in the system menu

Connector for DSC function (DSC)

You can operate the transmitter without transmitting radio waves by connecting the transmitter and the receiver to the DSC cable.

*Please refer to the section "Connection between Receiver/Servo"

S.BUS connector (S.I/F)

When setting an S.BUS servo and telemetry sensor, connect them both here.

(Supply power by 3-way hub or 2-way cord.)

Audio plug (PHONE)

Connecting a stereo headphone to this plug, you can enjoy music files stored in the SD card.

Connector for battery charger (CHG)

You cannot use the charger that was included with the transmitter, without using the AC adapter that comes with this.

Danger

-  Do not connect any other chargers. The charger for the receiver battery cannot be used for the transmitter.

USB port (mini-B)

*This is for factory use only.

Camera function

This transmitter has a digital camera function. A picture of your favorite model and other pictures (0.03M megapixels) can be allocated to transmitter model data.

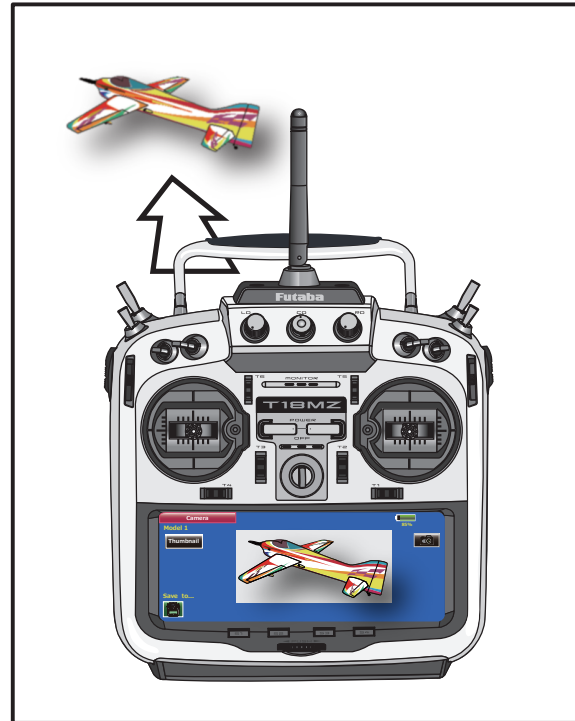
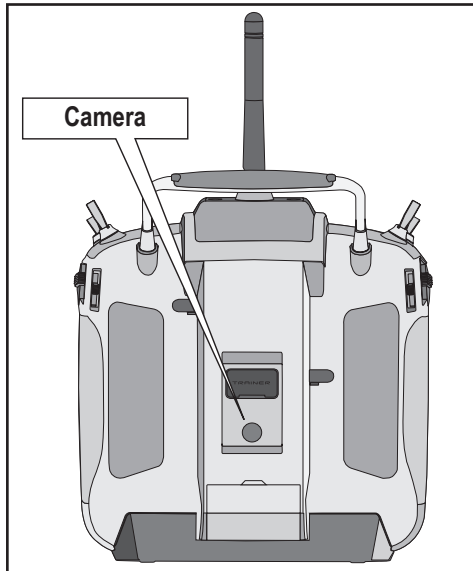

⚠ Warning

⊘ Do not use the camera function during flight and when starting the engine.

*It is dangerous to look away from or have your model out of your line of sight while flying.

Receiver nomenclature

Before using the receiver, be sure to read the precautions listed in the following pages.

Receiver R7008SB



Connector

"1 through 6": outputs for the channels 1 through 6

"7/B": outputs of 7 channels and power.

"8/SB": outputs of 8 channels or S.BUS port.

[S.BUS Sevo S.BUS Gyro] ———— ↑

"S.BUS2": outputs of S.BUS2 port.

[Telemetry Sensor] ———— ↑

*When using 9 or more channels, use an S.Bus function or use a second R7008SB and link both to your transmitter.

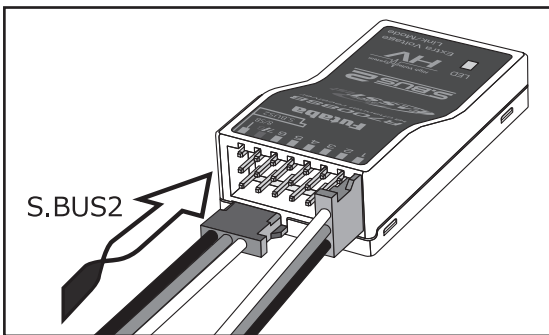

Connector insertion

Firmly insert the connector in the direction shown in the figure. Insert the S.BUS2 by turning it 90 degrees.

⚠ Warning

S.BUS2 connectors

❗ Don't connect an S.BUS servo / gyro to BUS2 connector.

LED Monitor

This monitor is used to check the CH mode of the receiver.

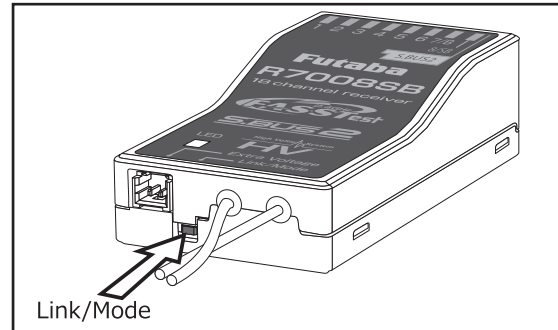

Link/Mode Switch

Use the small plastic screw driver that was included with your receiver.

The Link/Mode Switch is also used for the CH mode selection.

(The button is not used to link the transmitter and receiver together.)

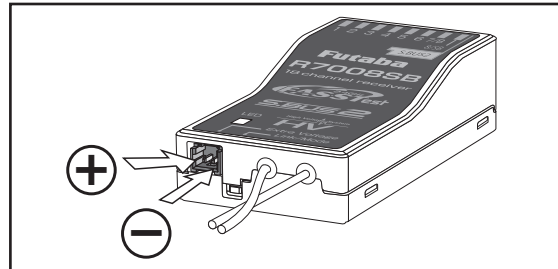

Extra Voltage Connector

Use this connector when using a voltage telemetry device to send the battery voltage (DC0 ~ 70V) from the receiver to the transmitter.

Please use an option is External voltage input cable. Wire in an extra connector to you drive batteries that mates with the extra voltage connector.

⚠ Danger

⊘ Don't touch wiring.

* There is a danger of receiving an electric shock.

⊘ Do not short-circuit the battery terminals.

* A short circuit across the battery terminals may cause abnormal heating, fire and burns.

⊘ Please double check your polarity (+ and -) when hooking up your connectors.

* If + and - of wiring are mistaken, it will damage, ignite and explode.

⊘ Don't connection to Extra Voltage before turning on a receiver power supply.

R7008SB CH Mode

The R7008SB receiver is a very versatile unit. It has 8 PWM outputs, S.Bus and S.Bus2 outputs. Additionally the PWM outputs can be changed from channels 1-8 to channels 9-16. If you only desire to use it as an 8 channel receiver (without S.Bus), it can be used without any setting changes.

The T18MZ has the ability to link to two R7008SB receivers. One of them outputting channels 1-8 and the other outputting channels 9-16 giving you 16 PWM channels. Instructions for this configuration and S.Bus operation follow.

[How to change the R7008SB Channel mode.]

1. Press and hold down the Link/Mode button on the R7008SB receiver.
2. Turn the receiver on while holding down the Link/Mode button. when the LED begins to blink green/red the button may be released.
3. The LED should now be blinking red in one of the patterns described by the chart below.
4. Each press of the Mode/Link button advances the receiver to the next mode.
5. When you reach the mode that you wish to operate in, press and hold the Mode/Link button for more than 2 seconds.
6. Once locked into the correct mode the LED will change to a solid color.
7. Please cycle the receiver(s) power off and back on again after changing the Channel Mode.

R7008SB CH MODE TABLE

Receiver connector	Setting channel			
	Mode A 1 ~ 8CH	Mode B 1 ~ 7CH	Mode C 9 ~ 16CH	Mode D 9 ~ 15CH
1	1	1	9	9
2	2	2	10	10
3	3	3	11	11
4	4	4	12	12
5	5	5	13	13
6	6	6	14	14
7/B	7	7	15	15
8/SB	8	S.BUS	16	S.BUS
Red LED blink	1time	2time	3time	4time

Servo(Optional) • Toolbox

Servo(Optional)

Purchase servos appropriate for their intended use.

*Analog servos may not be used when operating in the FASSTest 12CH mode.

When operating in the FASSTest12Ch mode use digital servos, this includes all brushless and S.Bus servos.

Toolbox

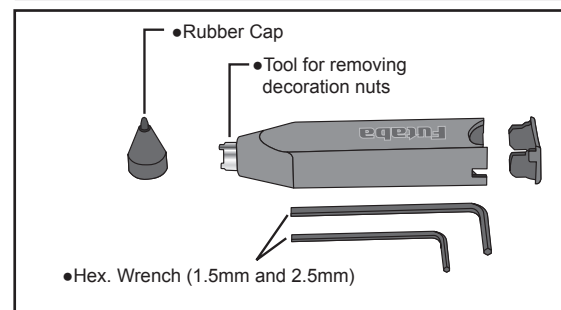

A special toolbox is included with your T18MZ. This allows you to make off of the mechanical adjustments that may be needed.

Hexagonal wrench (1.5mm and 2.5mm)

These wrenches are for adjustment of sticks, replacement of the switches.

Tool for removing switch nuts.

This is used when changing or replacing switches.

Stylus pen

A rubber cap is attached to the stylus pen/toolbox. You may use this stylus with rubber cap when operating the touch panel. The stylus allows more precise operation than fingers without fear of damaging the panels surface.

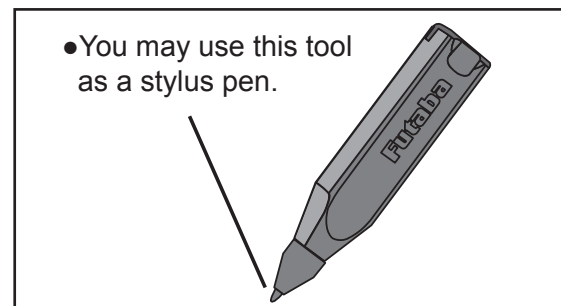

Receiver's Antenna Installation

The R7008SB has two antennas. In order to maximize signal reception and promote safe modeling Futaba has adopted a diversity antenna system. This allows the receiver to obtain RF signals on both antennas and fly problem-free.

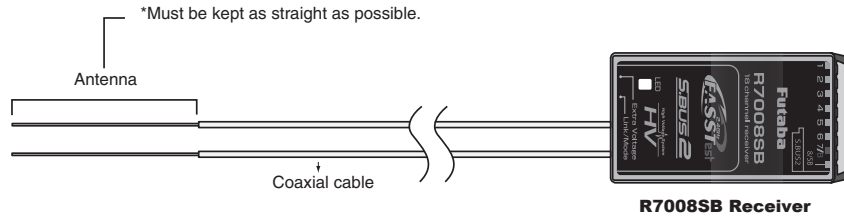

To obtain the best results of the diversity function, please refer to the following instructions:

1. The two antennas must be kept as straight as possible. Otherwise it will reduce the effective range.
2. The two antennas should be placed at 90 degrees to each other.

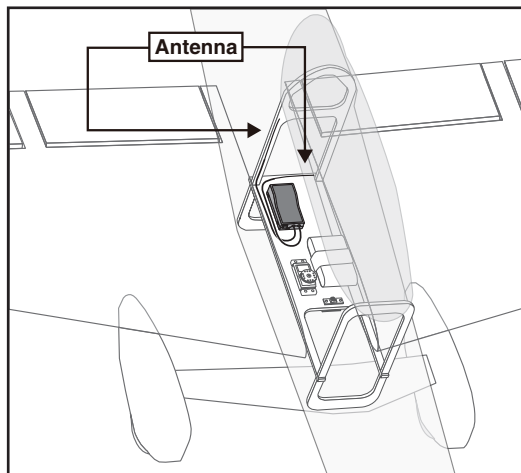
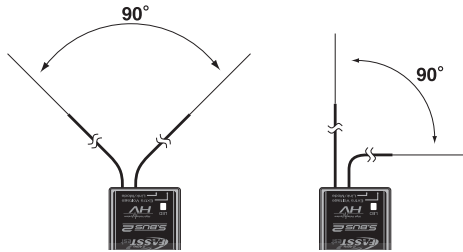

This is not a critical figure, but the most important thing is to keep the antennas away from each other as much as possible.

Larger models can have large metal objects that can attenuate the RF signal. In this case the antennas should be placed at both sides of the model. Then the best RF signal condition is obtained at any flying attitude.

3. The antennas must be kept away from conductive materials, such as metal, carbon and fuel tank by at least a half inch. The coaxial part of the antennas does not need to follow these guidelines, but do not bend it in a tight radius.
4. Keep the antennas away from the motor, ESC, and other noise sources as much as possible.

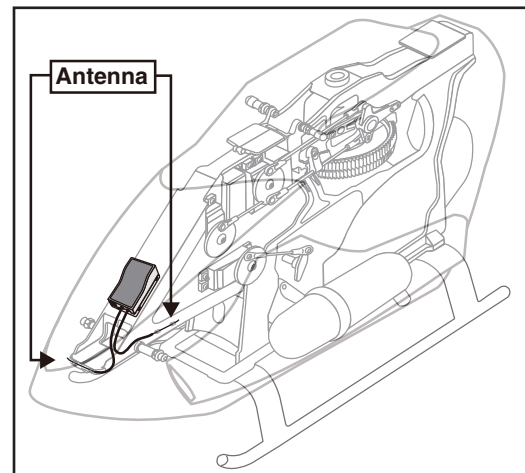

*The two antennas should be placed at 90 degrees to each other.

*The Illustration demonstrates how the antenna should be placed.

*Receiver Vibration and Waterproofing: The receiver contains precision electronic parts. Be sure to avoid vibration, shock, and temperature extremes. For protection, wrap the receiver in foam rubber or other vibration-absorbing materials. It is also a good idea to waterproof the receiver by placing it in a plastic bag and securing the open end of the bag with a rubber band before wrapping it with foam rubber. If you accidentally get moisture or fuel inside the receiver, you may experience intermittent operation or a crash. If in doubt, return the receiver to our service center for service.

Mounting the Servo

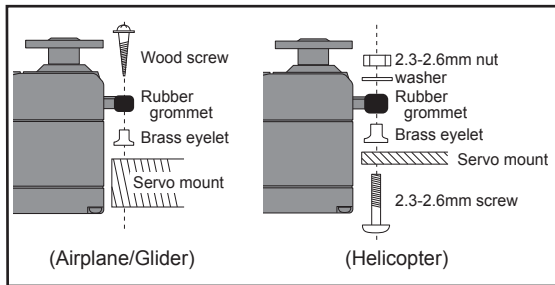

Servo lead wires

To prevent the servo lead cable from being broken by vibration during flight, provide a little slack in the cable and fasten it at suitable points. Periodically check the cable during daily maintenance.

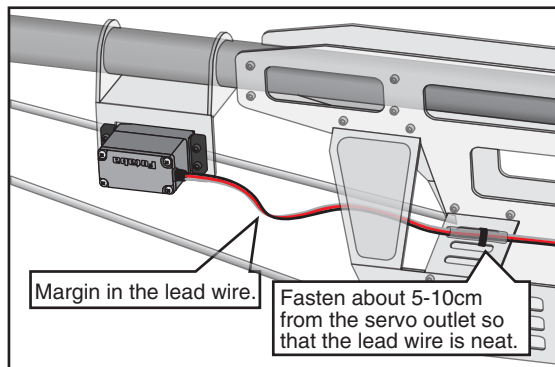

Mounting the power switch

When mounting a power switch to an airframe, make a rectangular hole that is a little larger than the total stroke of the switch so that you can turn the switch ON/OFF without binding.

Avoid mounting the switch where it can be covered by engine oil and dust. In general, it is recommended to mount the power switch on the side of the fuselage that is opposite the muffler.

Safety precautions when you install receiver and servos

⚠ Warning

Connecting connectors

- ⚠ Be sure to insert the connector until it stops at the deepest point.

How to protect the receiver from vibration and water

- ⚠ Wrap the receiver with something soft such as foam rubber to avoid vibration. If there is a chance of getting wet, put the receiver in a waterproof bag or balloon to avoid water.

Receiver's antenna

- ⊘ Never cut the receiver's antenna. Do not bind the receiver's antenna with the cables for servos.

- ⚠ Locate the receiver's antenna as far as possible from metals or carbon fiber components such as frames, cables, etc.

*Cutting or binding the receiver's antenna will reduce the radio reception sensitivity and range, and may cause a crash.

Servo throw

- ⚠ Adjust your system so that pushrods will not bind or sag when operating the servos to the full extent.

*If excessive force is continuously applied to a servo, the servo could be damaged due to force on the gear train and/or power consumption causing rapid battery drain.

Mounting servos

- ⚠ Use a vibration-proof rubber (such as rubber grommet) under a servo when mounting the servo on a servo mount. And be sure that the servo cases do not touch directly to the metal parts such as servo mount.

*If the servo case contacts the airframe directly, vibration will travel to and possibly damage the servo.

S.BUS Installation

This set uses the S.BUS system. The wiring is as simplified and clean mounting as possible, even with models that use a large number of servos. In addition, the wings can be quickly installed to the fuselage without any erroneous wiring by the use of only one simple wire, even when there are a large number of servos used.

- When using S.BUS, special settings and mixes in your transmitter may be unnecessary.
- The S.BUS servos and S.BUS gyros memorize the number of channels themselves. (Settable with the T18MZ)
- The S.BUS system and conventional system (receiver conventional CH used) can be mixed.

S.BUS Glider Usage example

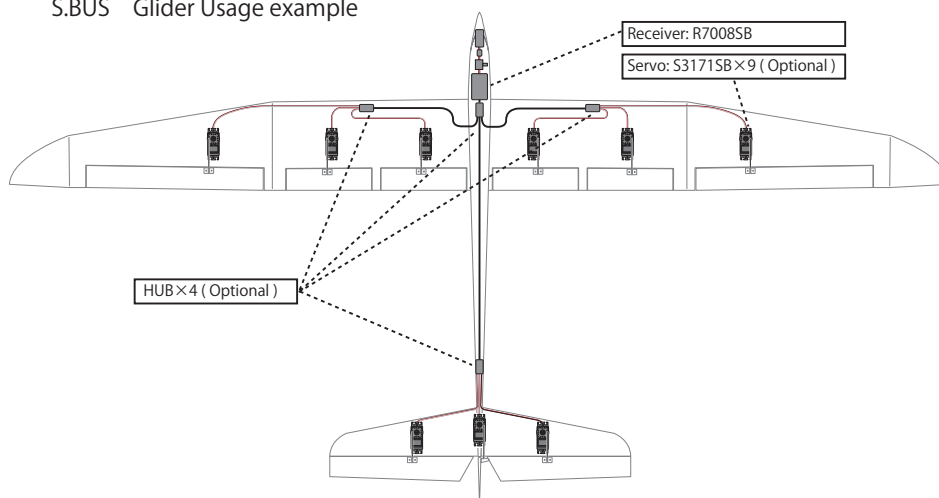

S.BUS Aerobatic Airplane Usage example

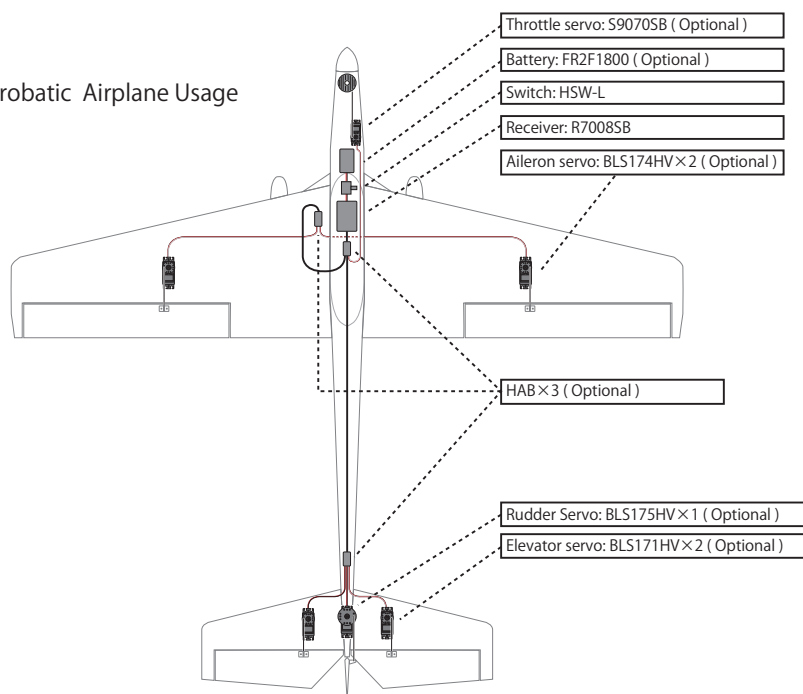

S.BUS Wiring example

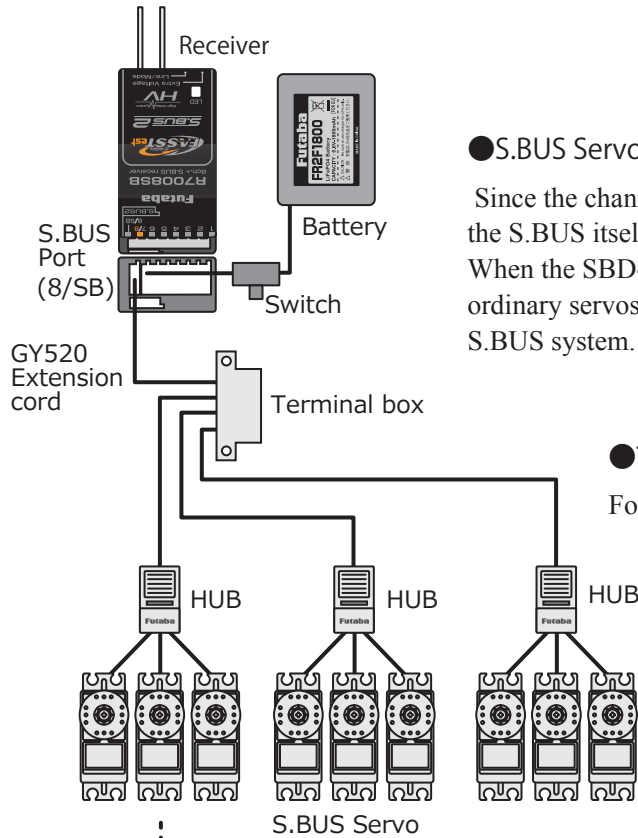

● S.BUS Servo

Since the channel number is memorized by the S.BUS itself, any connector can be used. When the SBD-1 (sold separately) is used, ordinary servos can be used with the S.BUS system.

● Terminal box



Four connectors can be inserted

⚠ Warning

Power supply

! Please make sure that you use a battery that can deliver enough capacity for the number and kind of servos used. Alkaline batteries cannot be used.

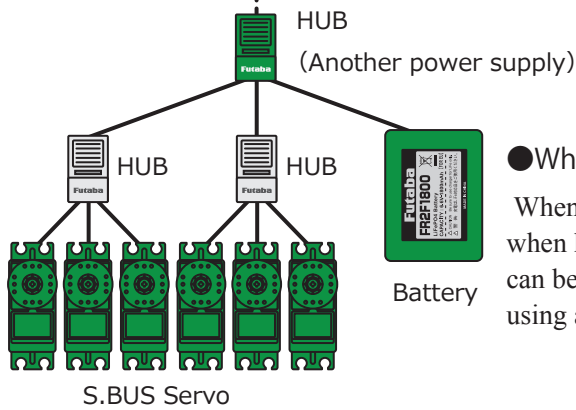

● When separate power supply used

When a large number of servos are used or when high current servos are used, the servos can be driven by a separate power supply by using a separate Power Supply 3-way Hub.

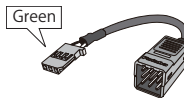

HUB (Another power supply)

Used when using a separate power supply battery.

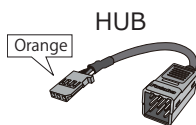

HUB

Three connectors can be inserted.

S.BUS2 System

Using the S.Bus2 port an impressive array of telemetry sensors may be utilized.

S.BUS2 TABLE

Receiver connector	S.BUS Servo S.BUS Gyro	telemetry sensor
S.BUS	○	×
S.BUS2	× (※)	○

(※) Don't connect S.BUS Servo,
S.BUS Gyro to BUS2 connector.

S.BUS device setting

S.BUS servos or a telemetry sensor can be connected directly to the T18MZ. Channel setting and other data can be entered for the S.BUS servos or sensors.

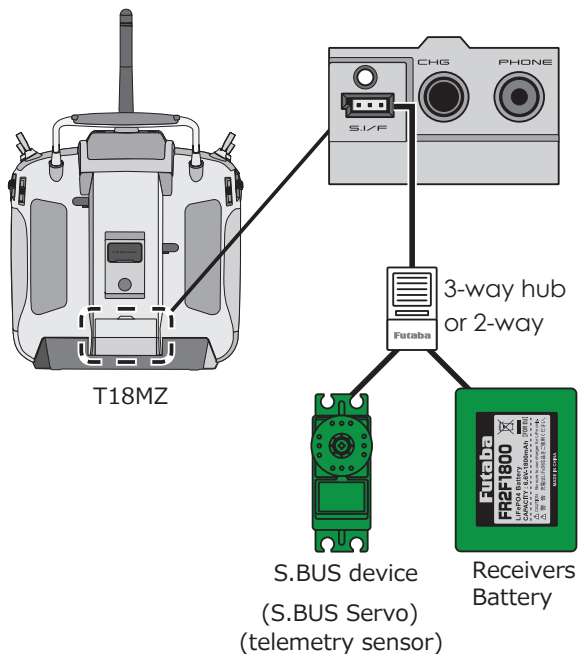

1. Connect the S.BUS device and battery you want to set with a 3-way hub or 2-way cord as shown in the figure.
2. Turn on the transmitter power.
3. Call the setup screen.
Servo: System Menu → S.BUS Servo
Sensor: Linkage Menu → Sensor
4. Perform setting in accordance with each screen.
5. This sets the channel and other data for each S.BUS servo, or telemetry device to be used with the S.BUS device or receiver.

Telemetry System

The R7008SB receiver features bi-directional communication with a FASSTest Futaba transmitter using the S.Bus2 port. Using the S.Bus2 port an impressive array of telemetry sensors may be utilized. It also includes both standard PWM output ports and S.Bus output ports.

*Telemetry is available only in the FASSTest 18CH mode. (12CH mode displays only Receiver battery voltage and Extra battery voltage.)

*The telemetry function requires the corresponding receiver (R7008SB).

* Telemetry display only T18MZ ID of R7008SB was remembered to be.

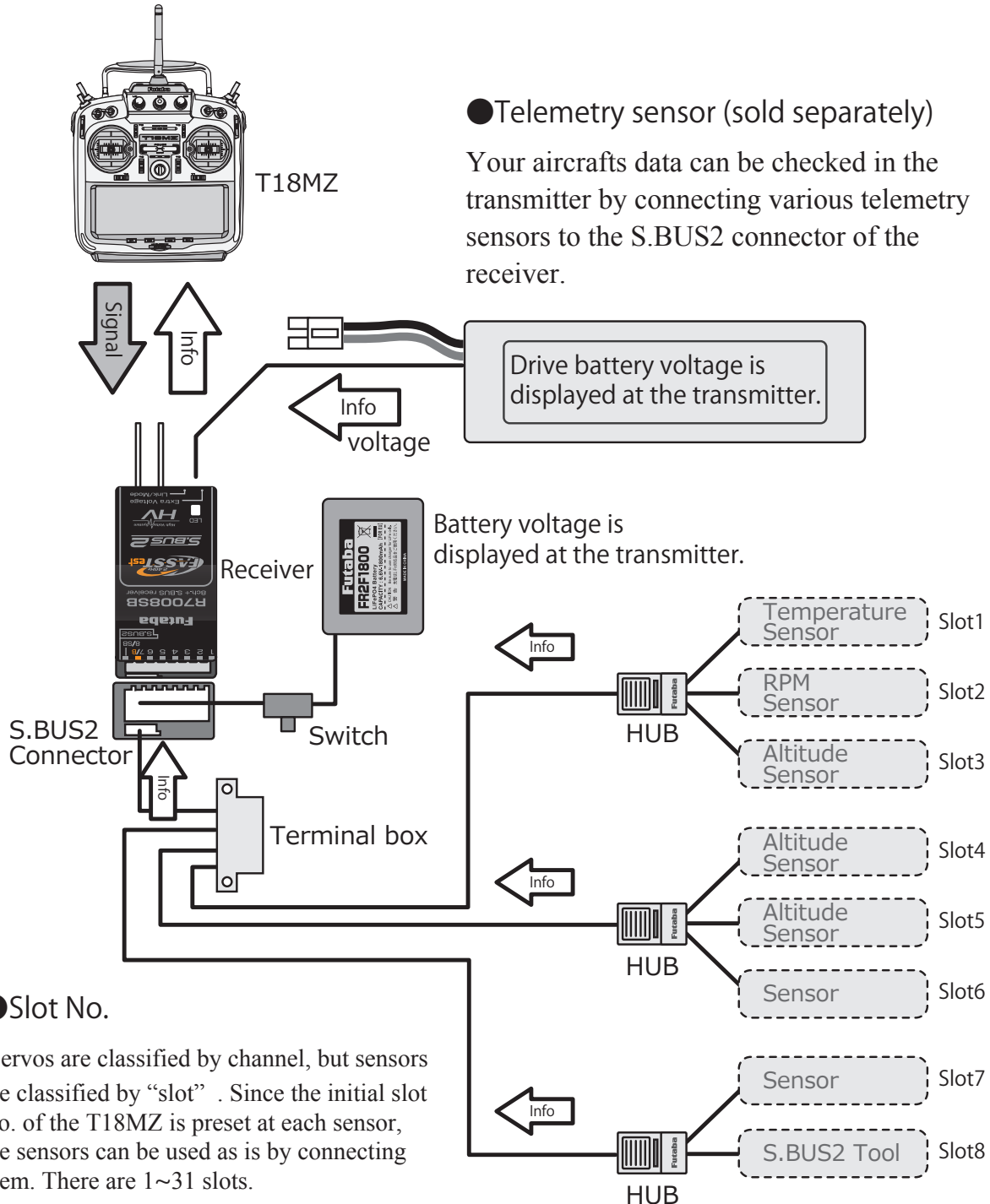

BASIC OPERATION

Battery Charging

Before charging batteries, read the "Cautions for handling battery and battery charger" in the section "For your safety".

Charging the transmitter LT2F3500XH lithium-polymer battery

⚠ Danger

⊘ The LT2F3500XH lithium-polymer battery is for the T18MZ transmitter only. Do not use it with other devices.

! Always use the accessory AC adapter to charge the battery.

The charging circuit is built into the T18MZ.

[Method of charging battery]

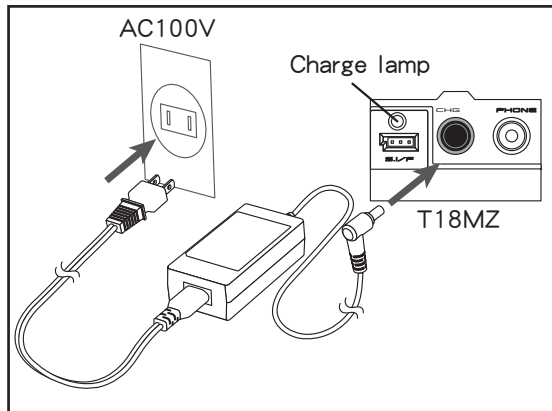

1. Turn off the transmitter power.
2. Connect the power plug of the AC adapter to an 110V outlet.
 - *Don't connect AC plug to the T18MZ without connecting with a 110V outlet.
3. Open the back lid of the transmitter and insert the plug of the AC adapter into the CHG port.
4. The charging monitor of the transmitter lights red.
 - *The LCD screen will come on for several seconds and then go off. It may take several seconds for charging to start after the AC adapter is connected.
5. When the battery is fully charged the transmitter monitor will light green. Remove the charge plug and AC adaptor.
 - *After using the AC adaptor always disconnect the power cord from the AC outlet.
 - *The time to charge a completely discharged battery pack is approximately 2 hours 30 minutes. However, the actual charging time may vary depending on temperature and state

of the battery.

*If the battery is improperly installed or is faulty, the transmitter monitor will not light and the battery will not charge.

How to charge the Li-Fe battery FR2F1800(Optional) for the receiver

Use the battery charger that is included in the set.

[Method of charging battery]

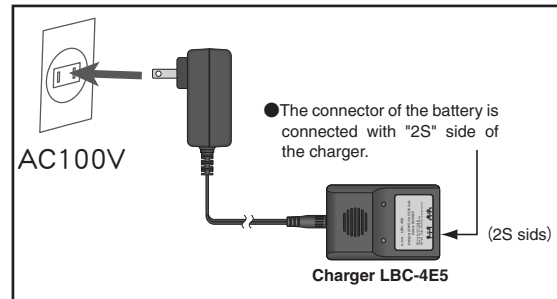

1. Connect the power cable of the charger to the wall socket (AC outlet).
2. Connect the connector to the Li-Fe battery.
 - *Confirm that the charging indicator, red LED lights.
3. Remove the battery after the LED light turns green.
 - *After completing the charge remove the battery from the charger and remove the charger from the wall outlet.

⚠ Warning

⊘ The transmitter battery cannot be charged with the receiver charger. Conversely the receiver battery cannot be charged with the transmitter charger.

How to turn ON/OFF the power of the transmitter

Windows® CE is installed as a built-in operating system in the T18MZ transmitter. Compared to the conventional system, the T18MZ takes extra time for internal processing when it is turned on/off.

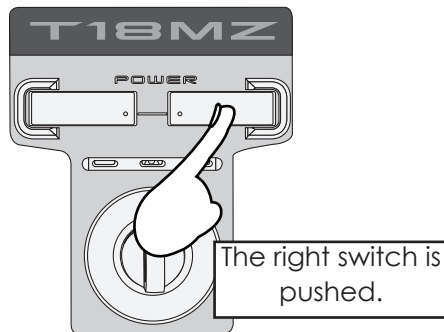

When turning on the power of the transmitter

1. Place the throttle stick below 1/3 closed.
2. Turn on the power switch.

*After initialization of the transmitter is complete, the LED monitor turns Purple.

*If your throttle stick is not at 1/3 closed or fully closed, a warning will sound. If you move the throttle to 1/3 closed or fully closed, the warning will stop and will become a "Transmit?" screen.

*If you push the button "NO", then the transmitter will not emit radio waves.

*If you push the button "Yes", then the transmitter will emit radio waves..

*If a battery is removed and it re-connects, please switch on a power supply, after 3 seconds or more pass.

Start-up time;

The time required to initialize the internal circuit of the transmitter varies between the previous time you turned the power off and then restarted the transmitter. There are two "start up" modes for your transmitter, see below:

Cold start;

If you turn on the transmitter more than four hours after you last turned it off, the mode is "Cold start". "Cold start" is normal for the first initial power up of the day. It will take about 30 seconds to be ready for use, as it takes time to initialize the internal circuit of the transmitter.

Hot start;

If you turn on the transmitter less than four hours after you last turned it off, the mode is "Hot start". Since initialization has been partly completed, the transmitter will be ready to use in several seconds.

"Hot start" takes place usually at a second flight or later flight in the day.

Warning

- ⊘ Once you turn on the power, never shut off the power switch until the power becomes stable (or until the first screen shows up). If you turn off the power switch while the transmitter is going through the initialization process, the data could be damaged. Note: The start-up time may be a little bit slower when the SD card is installed compared to when the card is not.

How to stop the transmitter

Turn off the power switch of the transmitter. The internal circuit of the transmitter starts the shut down process including saving the set-up data.

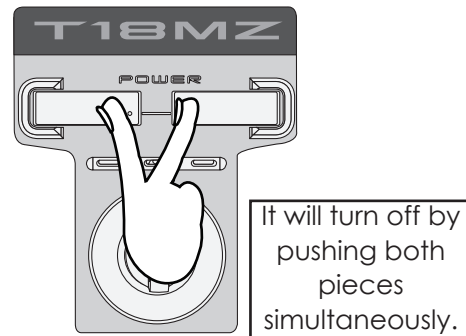

or

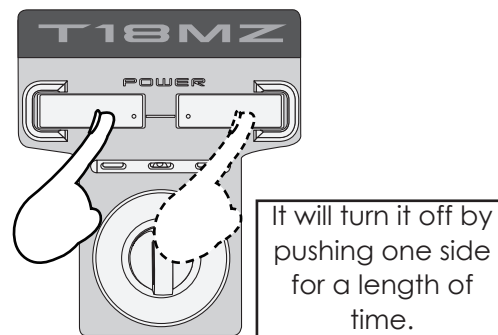

- ⊘ Once you turn off the power, never operate the power switch until the power shutdown process is fully completed. If you turn on the power switch again while the transmitter is still in the process of power shutdown, the data could be damaged.

As the internal circuit of the transmitter stays on the standby mode for 4 hours after turning

off the power, some part of the circuit is consuming current. When you turn on the power during this period, the power starts in “Hot mode”. But if more than four hours pass after shutting down the power, the power supply will completely shut down the internal circuit. When you turn on the power after this point, the power starts in “Cold start mode”.

How to reset software

If the screen freezes for some reason and you cannot edit, the transmitter power supply is not fully off even if you turn OFF the power switch. You will need to remove the battery and reinsert it again. In this case, the power restarts in “Cold mode”. Even though the screen freezes, all the other functions for radio control operation remain operative.

Registration of the user's name

T18MZ transmitter can register user's name.

How to register user's name

1. Turn on the power of the transmitter.
2. Push the area of the user's name shown on the home screen or the "user's name" in the linkage menu. Then the User's Name Set screen will pop up.

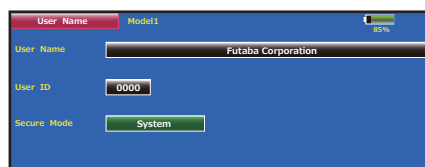

3. Push the user's name. Then the keyboard will pop up. You can use up to 32 characters as a user's name. Use the keyboard on the screen to enter user's name.

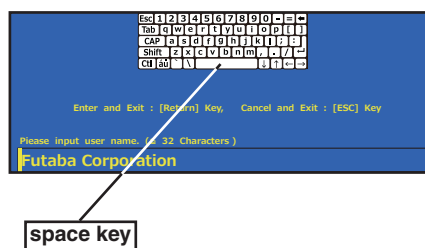

4. Push "Return" key to return to the previous screen after entering the user's name.

(If you want to protect the user's name)

If you don't want anybody else to change your user's name, set your ID in the following way.

*Please be aware that you will not be able to change user's name if you forget your password.

1. Make sure that the security mode is "User's name", and then push the User ID button.
2. Enter your password, using keyboard on the screen. You will need to enter your password for changing the user's name, the next time you turn on the power.

*Even if you enter the same character, your password will be identified differently depending on whether you are using "Transform" mode or "Direct" mode for inputting.

Home screen

This is the Home screen and descriptions of its menus. Use your finger or included stylus pen to operate the touch screen.

<p>① Timer</p> <p>If one of two timer displays is pushed, you will enter the Timer screen of a Linkage menu.</p>	<p>⑩ User's name</p> <p>Push this area to enter the User's Name Setting screen.</p>
<p>② Menu Button</p> <ul style="list-style-type: none"> • System • Linkage 	<p>⑪ Condition</p> <p>The condition name that is currently used is displayed here.</p> <ul style="list-style-type: none"> • Push this area to enter the Condition Select screen.
<p>③ System Selection</p> <ul style="list-style-type: none"> • FASSTest 18CH • FASSTest 12CH • FASST MULTI • FASST 7CH • S-FHSS 8CH 	<p>⑫ Battery Indicator</p> <ul style="list-style-type: none"> • When the remaining battery reaches 30%, the alarm will beep. Land your aircraft immediately.
<p>④ System timer/Reset</p> <ul style="list-style-type: none"> • This shows the total accumulated time used for the transmitter. This can be reset. (Hour):(Minute):(Second) <p>Push this area to reset the timer.</p>	<p>⑬ Menu Button</p> <ul style="list-style-type: none"> • Model
<p>⑤ Voltage of Rx/Ext battery</p> <p>Information from the receiver is displayed when using a bidirectional system. FASSTest Only.</p>	<p>⑭ Model Name</p> <p>The model name that is currently used is displayed here.</p> <ul style="list-style-type: none"> • Push this area to enter the Model Select screen.
<p>⑥ Direct buttons</p> <p>Select and press one of the direct buttons to enter the menu.</p>	<p>⑮ Clock</p> <p>This shows the today's date and the current time.</p> <ul style="list-style-type: none"> • Push this area for the Date & Time Setting screen.
<p>⑦ Home2</p> <p>A timer and Telemetry data change to Home2 screen by which it was indicated by expansion.</p>	<p>⚠ Warning</p> <ul style="list-style-type: none"> ❗ Be sure to confirm the model name before flying your aircraft. ❗ Check the remaining battery as often as possible and try to charge the battery regularly. If the battery alarm sounds and its warning symbol is displayed, land your aircraft immediately.
<p>⑧ RF Indicator</p> <p>"ON AIR" or "RF OFF"</p>	
<p>⑨ Digital trim (T1 to T6, CD)</p> <p>Push this area to enter the Dial Monitor screen.</p>	

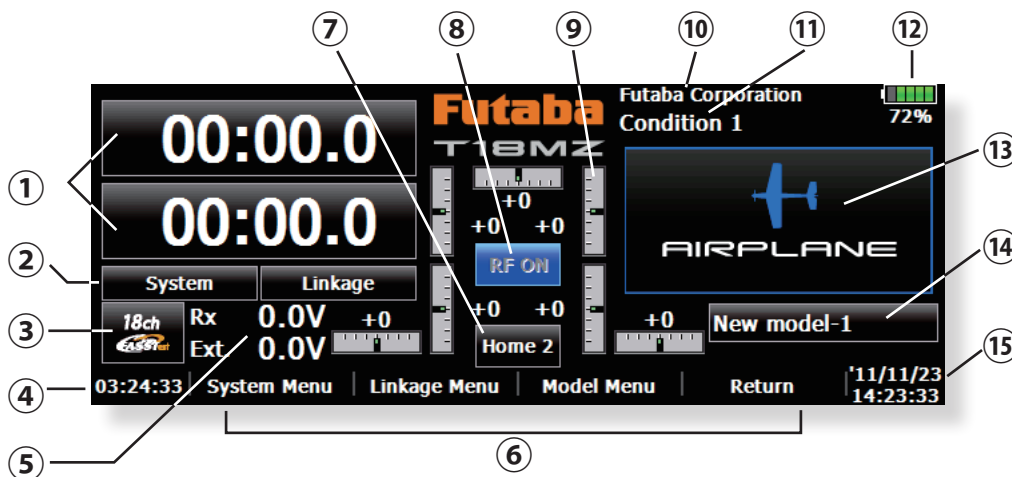

Home 2 screen

If [Home2] is pushed, it will become the display to which the timer and the Telemetry data were expanded.

• Return to home screen

Timer
If one of two timer displays is pushed, you will enter the Timer screen of a Linkage menu.

• Three telemetry data can be displayed.
If three either is pushed, it will move to a telemetry screen. Three displays can be changed on a telemetry screen.

User Menu

T18MZ has a menu for each of the following: System, Linkage, and Model. Also, you can create a personalized User Menu that can include all of the menus that you use most often.

The User menu can be created by pressing the Rotary Key.

How to make a User Menu

1. From the home screen, press the Rotary key for 2 seconds.

2. Touch here to select your first choice.

3. Once pressed, 4 pages of choices will be displayed.

4. Make your selection, press your choice and the first of your "User Menu" will be entered.

*Any change made to data entered from the User Menu or from the normal method of use are the same. Changes made in either way are saved into the transmitter memory.



• Return to home screen

User Menu	Model1	Normal	100%	1/2
-----	-----	-----	-----	-----
-----	-----	-----	-----	-----
-----	-----	-----	-----	-----
INH	Condition Hold	System Menu	Linkage Menu	Model Menu
	System Menu	Linkage Menu	Model Menu	Cond. Hold

• Return to User Menu

User Menu (Reg.)	Model1	Normal	100%	1/3
Trainer	Display	Date and Time	User Name	
Switch	H/W Setting	Sound Volume	Player	
Camera	S.BUS Servo	Information	Servo Monitor	
Model Select	Model Type	Picture	Sound	
INH	Condition Hold	System Menu	Linkage Menu	Model Menu
	System Menu	Linkage Menu	Model Menu	Cond. Hold

• Return to home screen

User Menu	Model1	Normal	100%	1/2
AFR (D/R)	Prog. Mixes	PIT Curve	THR Curve	
-----	-----	-----	-----	
-----	-----	-----	-----	
INH	Condition Hold	System Menu	Linkage Menu	Model Menu
	System Menu	Linkage Menu	Model Menu	Cond. Hold
				Release

• To erase a selection from your User Menu, highlight the desired menu and press Release. This will remove it from your personal User Menu, but not from the basic menu. You can always go back at a later date and re-enter this into your User Menu.

SYSTEM MENU

The System Menu sets up functions of the transmitter, this does not set up any model data.

- When the System Menu button is touched, the menu shown below is called up. Touch the function button that you want to enter.

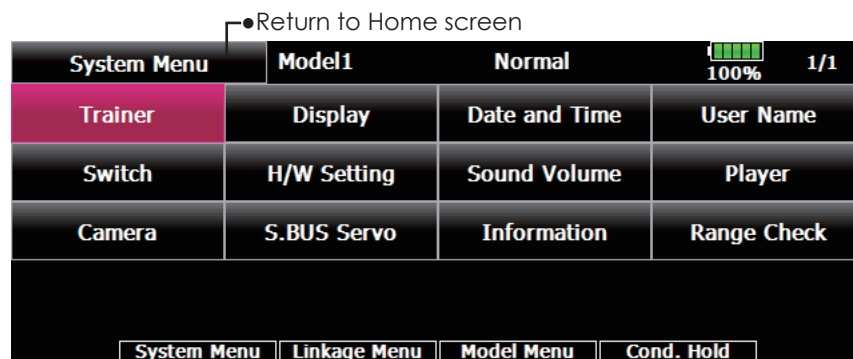

System Menu functions table

[Trainer]: Starts and sets the trainer system.

[Display]: Display adjustment and auto power off setting.

[Date & Time]: Sets the date and time (system clock setting) and resets the timer.

[User Name]: User name registration and ID Pin number.

[Switch]: Toggle switch type setting (Set when the switch is replaced.)

[H/W Setting]: Hardware reverse / Stick setting / Calibration.

[Sound Volume]: Adjust the volume of: Key Operation/Error Warning/Trim&Center Click/Timer Event

[Player]: Reproduction of music file.

[Camera]: Built in 0.3 megapixel camera.

[S.BUS Servo]: S.BUS servo setting.

[Information]: Displays the program version, SD card information, and product ID.

[Range Check]: The output of the transmitter is lowered, for Range checking.

Trainer

Trainer system set up and use.

T18MZ trainer system makes it possible for the instructor to choose which channels and operation modes that can be used in the student's transmitter. The function and rate of each channel can be set, the training method can also be matched to the student's skill level. Two transmitters must be connected by an optional Trainer Cord, and the Instructor's transmitter should be programmed for trainer operation, as described below.

When the Instructor activates the trainer switch, the student has control of the aircraft (if MIX/FUNC/NORM mode is turned on, the Instructor can make corrections while the student has control). When the switch is released the Instructor regains control. This is very useful if the student gets the aircraft into an undesirable situation.

- Setting data are stored to model data.
- Student rate can be adjusted at MIX/FUNC/NORM mode.
- Activated student channels can be selected by switches.

NOTE: This trainer system can be used in the following manner;

1. In the T18MZ (including FX-40, T12Z and T12FG) transmitter and a conventional transmitter, if the channel order is different. It is necessary to match the channel order in the Linkage Menu when connecting it with other than a T18MZ.
2. Be sure that all channels work correctly in both transmitters before flying.

Corresponding types of transmitters and trainer mode settings:

Types of transmitters		Instructor's transmitter settings		Student's transmitter settings			Trainer Cords
Instructor	Student	Freq. setting Mod. mode	Trainer setting CH mode	Freq. setting Mod. mode	Trainer setting CH mode	Mod. mode	
T18MZ	T18MZ	Arbitrary	16CH	Arbitrary	16CH	-	12FG/9C Trainer Cords
T18MZ	T14MZ, FX-40, T12Z, T12FG, FX-30	Arbitrary	12CH	PCM-G3 2.4G	12CH	PPM	
T18MZ	T8FG, FX-20	Arbitrary	12CH 8CH	FASST-MLT2 FASST-MULT	-	-	
T18MZ	T10C, T9C, T7C, T6EX, T4EX	Arbitrary	8CH	PPM	-	-	12FG Trainer Cords
T18MZ	T10CG, T7CG	Arbitrary	8CH	Arbitrary	-	-	12FG Trainer Cords
T18MZ	T8J, T6J	Arbitrary	8CH	Arbitrary	-	-	12FG/9C Trainer Cords
T14MZ, FX-40, T12Z, T12FG, FX-30	T18MZ	Arbitrary	12CH	Arbitrary	12CH	-	
T8FG, FX-20	T18MZ	Arbitrary	12CH	Arbitrary	12CH	-	
T10C, T10CG, T9C, T7C, T7CG, T8J	T18MZ	Arbitrary	-	Arbitrary	8CH	-	

- Touch the [Trainer] button in the System Menu to call the setup screen. The setup screen for the Teacher/Student mode is shown below.

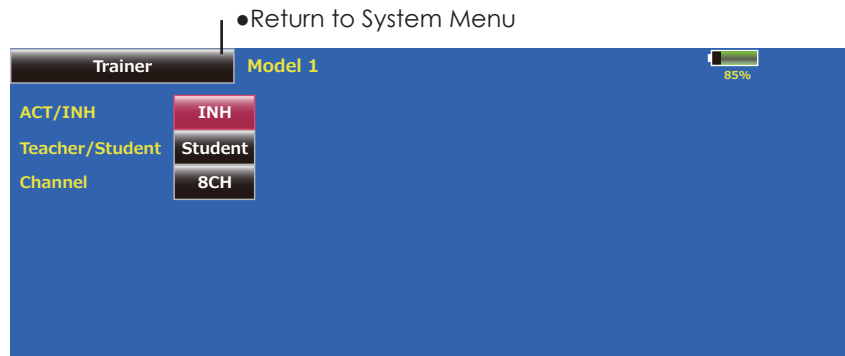

Student mode

1. Set "Teacher/ Student" button to "Student".
2. Change "ACT/INH" button from "INH" to "OFF" or "ON".
3. Set the CH mode to "16CH/12CH" or "8CH", see the above chart for the trainer mode

settings.

Note: In "student mode", only the teacher side can turn on and off the power of the student's transmitter. Keep the power switch always at off position.

- The setup screen for the instructor mode is shown below.

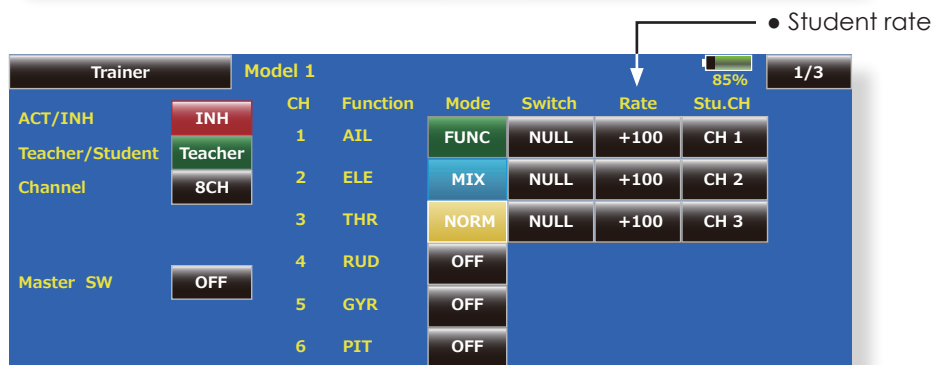
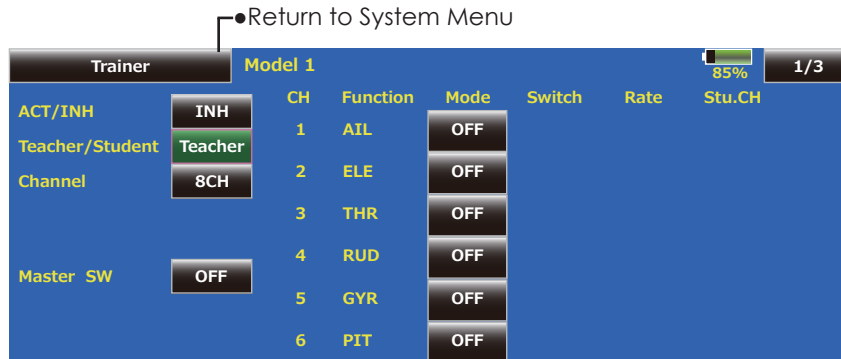

Teacher mode

1. Set "Teacher/Student" button to "Teacher".
2. Change "ACT/INH" button from "INH" to "OFF" or "ON".
3. Set the CH mode to "16CH/12CH" or "8CH", see the above-mentioned chart for the trainer mode settings.
4. Call up the Switch Setting screen by touching "Switch". Then set the desired switch and on/off direction.
5. Select the switch mode. If you select "NORM", the trainer function will be turned on or off by a switch position. If you select "ALT", ON and OFF of the trainer function switches alternatively every time the switch is turned on. This means the student side can be operated without holding the switch lever.
6. The Instructor side selects the channel for control. Three operating modes are available.

"NORM" mode (Normal mode);

The student will have none of the settings from the Teachers radio.

"MIX" mode;

Student has full advantage of all mixes and settings in Teachers radio. Plus the Teacher has the ability to override the student while the switch is activated.

"FUNC" mode (Function mode);

Student has control of all mixes and rate settings of Teachers radio.

7. Set the switches and rates of each channel.

Switch to the details setup screen by touching the page switching button [1/2] at the top right-hand corner of the screen. Student operation for each channel can be set here.

[Switch]: The switches that can be operated by the student can be set. SW-A~SWH, SS1, and SS3 can be selected.

[Rate]: Servo travel versus student operation can be set. (This can only be used in the FUNC/MIX/NORM modes.)

Note: In "teacher mode", the trainer function won't show that it is activated unless the Instructor's transmitter receives signals from the student's transmitter via the trainer cord. Be sure to confirm this after connecting your trainer cable.

Trainer student channel setting function

The channel function can be selected and re-arranged for the student transmitter (when using either "FUNC""MIX""NORM") in the Trainer function of the transmitter. This makes trainer connection easy even when the instructor and students channel assignment are different.

<Example of student CH setting>

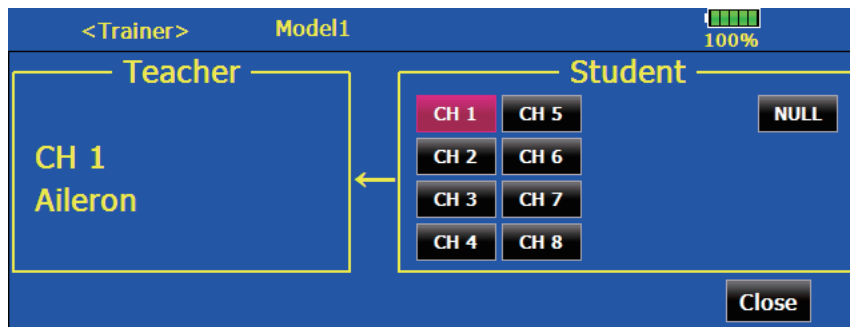
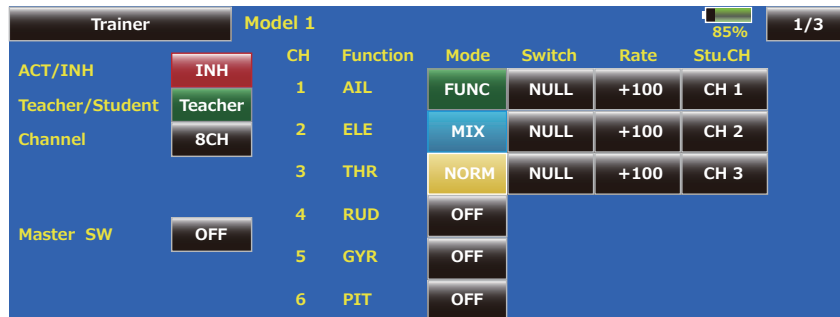
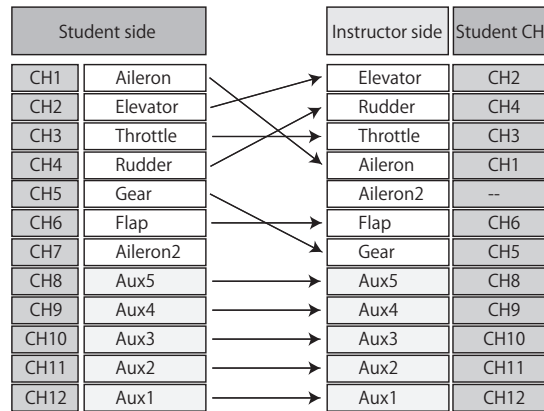

Student channel setting

1. Open the System Menu trainer screen.
2. Select [Teacher].
3. When [FUNC][MIX][NORM] is selected as the mode of the channel to be set, the [Student CH] setting button is displayed. (When [OFF], [Student CH] setting is not performed.)
4. When the [Student CH] button is pressed, the Channel Select screen is displayed. Select the channel.
 - (16CH mode---1-16CH)
 - (12CH mode---1-12CH)
 - (8CH mode---1- 8CH)

Display

LCD screen adjustment and auto power off setting

The following LCD screen adjustments and auto power off setting are possible:

- Auto power off time setting
 - Backlighting brightness adjustment
 - Background color change
 - Touch panel screen calibration correction
- Touch the [Display] button in the System Menu to call the setup screen shown below.

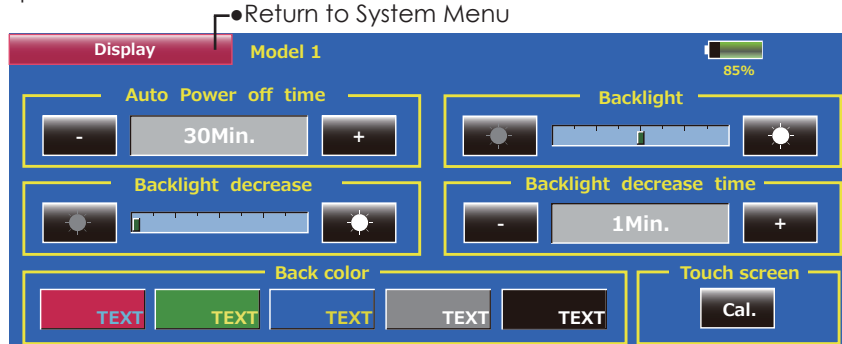

Auto power off time setting

The function to prevent a battery from discharging by failure of the power supply of a transmitter to erase.

1. Adjust the auto power off time with the left and right side buttons.

*When the time the transmitter is inactive reaches the set time, the power is turned off automatically. This time can be set up to 1 hour in 10 minutes increments. The auto power off function can also be deactivated.

*An audible alarm is sounded and an alarm screen is displayed from 3 minutes before auto power off and the time remaining until auto power off is displayed. When a stick or switch is operated while the alarm screen is being displayed, the alarm is cleared and the display is returned to the home screen.

Backlighting brightness adjustment

1. Adjust the backlighting brightness with the left and right side buttons.

*When the right side button is touched, the backlighting becomes brighter. When the left side button is touched, the backlighting becomes darker.

Backlight decrease brightness adjustment

1. Adjust the backlight decrease brightness with the left and right side buttons.

*When the right side button is touched, the backlighting becomes brighter. When the left side button is touched, the backlighting becomes darker.

*It cannot be made brighter than Backlighting brightness adjustment.

Backlight decrease time

You can set a time period to decrease the LCD backlight. This function counts the period that the touch panel has been not operated. This time can be set by ten-second steps. You can also turn off the backlight decrease" if you like.

*The backlight consumes a large amount of power. We recommend you to turn off the backlight by setting the backlight power-off time to about one minute.

Background color

1. Touch the button of the color you want to change.

*There are five background colors.

Touch screen calibration

This function adjusts the location of touch panel. Touch "Calibration" button and then press "Yes", the calibration screen will pop up. Touch the center of the cross hair cursor on the screen with the stylus pen. As soon as the system recognizes the position, the cursor will move on to the next position. Repeat this procedure as long as the cursor moves to next position. You will do this five times. Calibration will be carried out based on the five positions. Disappearance of the cross hair cursor means the calibration has been completed. Touch any point on the screen to return to the previous screen.

*In ordinary operation, this calibration is not necessary. If you notice the touch panel is not functioning correctly after long use, we recommend you to carry out this calibration.

Date and Time

Date and time setting (system clock setting) and integrating timer resetting

This function adjusts the system clock of the T18MZ transmitter. Perform this setting when you purchase the set and when adjustment is necessary.

The integrating timer can also be reset.

*The integrating timer is displayed on the Home screen.

- Touch the [Date and Time] button in the System Menu to call the setup screen shown below.

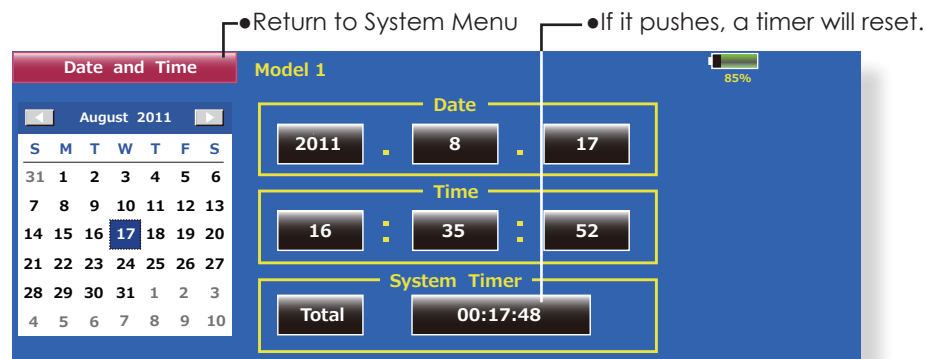

- Total : Regardless of a model, addition time in case a power supply is ON is displayed.

Model : The addition time when the power supply was set to ON is displayed for every model.

Date setting

1. Touch the "Year", "Month", or "Day" button and set the date by touching the [+] or [-] button.

*The date can also be set by pressing the date on the calendar shown at the left.

Time setting

1. Touch the "Hour" or "Minute" button, and set the time by touching the [+] or [-] button.
2. When the "Second" button is touched, the timer is set to "00" seconds.

Integrating timer reset

The integrating timer shows the total time that has elapsed since the last "reset".

1. When the [System Timer] button is touched, the timer is reset.

User Name

User name registration and PIN setting

This function registers the T18MZ user name.

A PIN can also be set to protect the set data or user name.

*Set the PIN carefully. When a system PIN is set, if you forget the PIN, none of the settings can be changed. In this case, the system must be reset by the Futaba Service Center.

- Touch the [User Name] button in the System Menu to call the setup screen shown below.

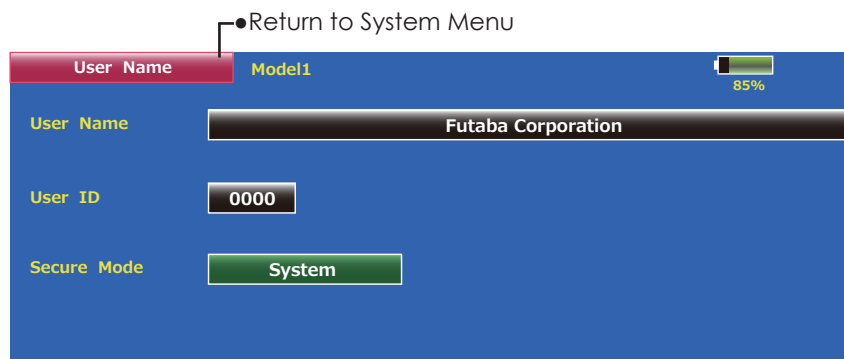

User name registration

1. When the User Name box is touched, a keyboard appears on the screen.
2. Enter the user name from this keyboard.

*A user name of up to 32 characters can be entered.

*The set user name is displayed on the Home screen.

(For a detailed description of the input method, see [User Name Registration/Character Input Method] in the Basic Operation section.)

User name or set data protection

1. Touch the Security Mode button and select the mode. The mode is switched each time the button is touched.

*User Name: Select when you want to protect the user name only.

*System: Select when you want to protect all the set data.

2. When the user ID button is touched, a PIN input screen appears. Input a PIN of up to 4 digits.

3. When the "Return" key is touched, the display returns to the preceding screen.

4. When the transmitter power is turned off, the set security mode becomes active.

*When a PIN is set for the user name, it must be entered each time the User Name screen is opened.

When a System PIN is set, a button displaying a key icon appears on the Home screen.

When you want to change any settings, touch this button and enter the PIN.

If you want to nullify your current password, set the password to "0000" (default value).

Switch Toggle switch type setting (Setting when the switch was replaced.)

If you modify the location of the switches on the right and left (top) of the transmitter, you should be sure to re-assign functions to the switches for proper operation.

A "Lock" is included to prevent settings from being modified by mistake. When you need to change settings, unlock this by pressing "Lock" it will then read "Unlock" and you can make changes as required.

- Touch the [Switch] button in the System Menu to call up the setup screen shown below.

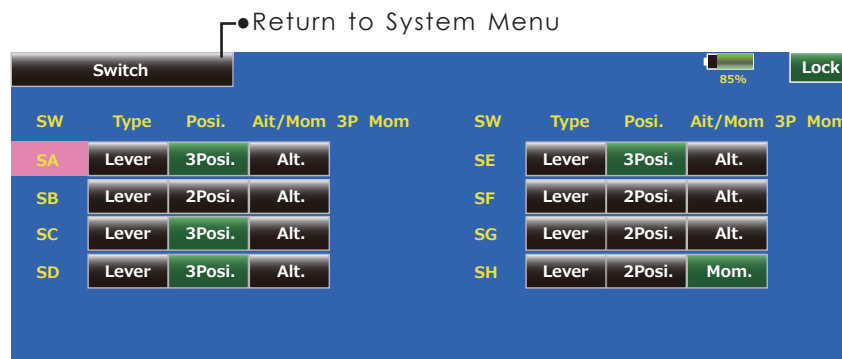

Switch selection

1. Select the switch type by touching the [Type] button corresponding to the switch to be replaced.

[Lever]: Toggle switch

[Button]: Pushbutton

[Dial]: Knob

- Setting for toggle switch is shown above.

2/3 position selection

1. Touch the "Posi." button corresponding to the switch and select the position type.

[2 Posi]: 2 position

[3 Posi]: 3 position

[Alt/Mom] mode selection

1. Select the operation mode by touching the [Alt/Mom] button corresponding to the switch.

[Alt.]: Alternate type

[Mom.]: Self-return type

- Selection of the [Mom.] mode with a 3-position type switch is shown above.

"3P Mom" mode selection

1. Select the operation mode by touching the "3P Mom" button corresponding to the switch.

[Single]: One-side self-return type

[Dual]: Both directions self-return type

H/W Setting

Stick, switch, trim lever, and knob operation direction reversal (Hardware reverse)/Stick response and hysteresis adjustment (Stick Setting)/Calibration

This function is for adjusting the sticks, switches, and trim characteristics. It is not unless necessary.

H/W Reverse

This function reverses the operation signal of the sticks, switches, trimmer levers, and knobs.

Note: This setting reverses the actual operation signal, but does not change the display of the indicators on the display. Use the Normal mode as long as there is no special reason to use the Reverse mode.

Stick Setting

This function sets the servo response and hysteresis for stick operation for each condition. The control feeling of the stick can be adjusted to match the aerobatics.

Calibration

Usually, this calibration is unnecessary.

Please perform this calibration, only if a change at the center of a stick should arise after prolonged use.

- Touch the [H/W Setting] button at the System Menu to call the setup screen shown below.

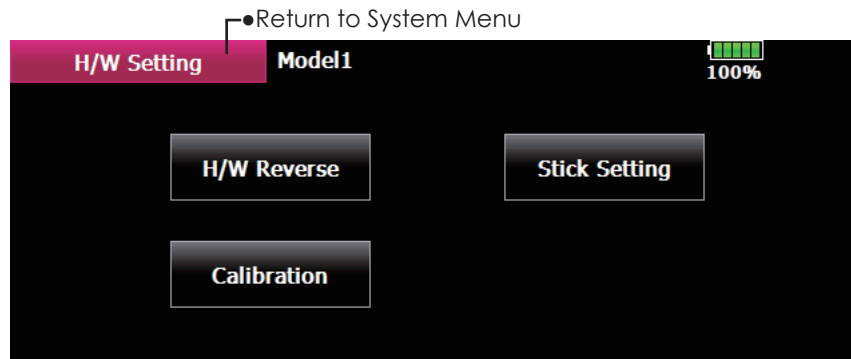

- Touch the [H/W Reverse] button at the H/W Setting Menu to call the setup screen shown below.

H/W Reverse		Model1						100%	
H/W	Setting	H/W	Setting	H/W	Setting	H/W	Setting	H/W	Setting
J1	NORM	T1	NORM	SA	NORM	SE	NORM	LST	NORM
J2	NORM	T2	NORM	SB	NORM	SF	NORM	LS	NORM
J3	NORM	T3	NORM	SC	NORM	SG	NORM	LD	NORM
J4	NORM	T4	NORM	SD	NORM	SH	NORM	RD	NORM
CD	NORM	T5	NORM					RS	NORM
CD-SW	NORM	T6	NORM					RST	NORM

Operation direction reversal method

1. Touch the setting button corresponding to the H/W (Hardware) you want to reverse.
2. Reverse the H/W by touching [Yes]. (When you want to stop operation, touch [No].)
 [Normal]: Normal operation direction
 [Reverse]: Reverses the operation direction.

- Touch the [Stick Setting] button at the H/W Setting Menu to call the setup screen shown below.

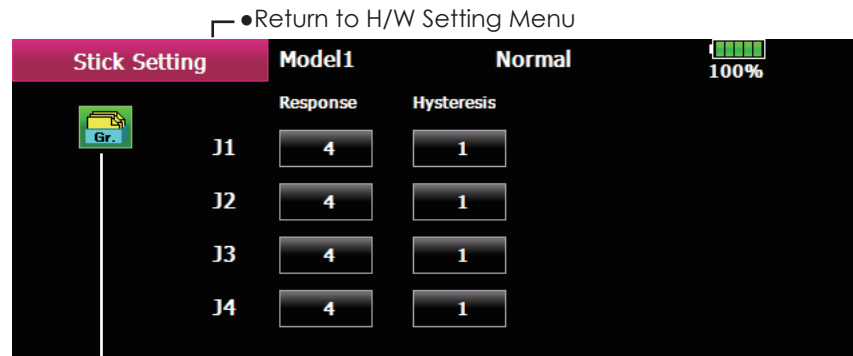

- Group/single mode switching (Gr./Sngl)
(For more information, see the description at the back of this manual.)

Response adjustment

1. Touch the setting button corresponding to the stick whose response you want to adjust. Adjustment buttons appear on the right-hand side of the stick setup screen.
2. Use the adjustment buttons to adjust the response.
Initial value: 4
Adjustment range: 1~16 (When the adjustment value is large, the response becomes slow.)

Hysteresis adjustment

1. Touch the setting button corresponding to the stick whose hysteresis you want to adjust. Adjustment buttons appear on the right-hand side of the stick setup screen.
2. Use the adjustment buttons to adjust the hysteresis.
Initial value: 1
Adjustment range: 0~32 (When the adjustment value is large, the hysteresis value becomes large.)

- Touch the [Calibration] button at the H/W Setting Menu to call the setup screen shown below.

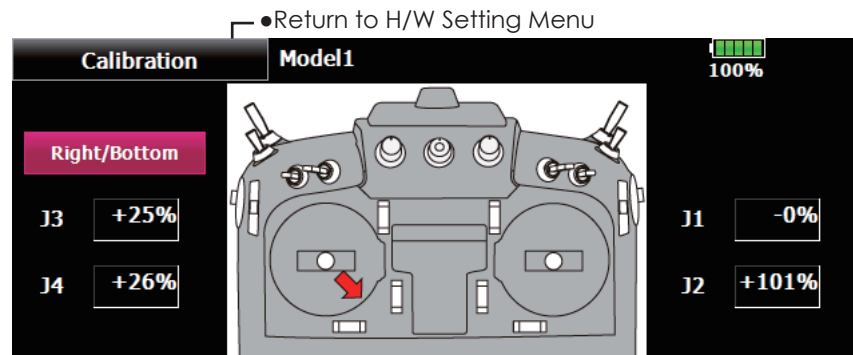

How to Calibrate

1. Choose the stick to calibrate right and left.
2. The stick is set at neutral and the [neutral] button is pushed.
3. The stick is held at full right and full bottom (diagonal) the [Right/Bottom] button is pushed.
4. The stick is held at full left and full top (diagonal) the [Left/ Top] button is pushed.

*Please do not press the stick too firmly in any direction when doing the calibration.

*Check after calibration to make sure that neutral is 0% and bottom right side will be +100%, and the top left side is become -100%.

Sound Volume

Sound Volume setting

This function can set the volume of "Key Operation" "Error/Warning" "Trim&Center Click" "Timer Event" respectively.

*If you have set the PIN try not to forget it. When a system PIN is set, if you forget the PIN, none of the settings can be changed or entered. In this case, the system must be reset by the Futaba Service Center.

- Touch the [Sound Volume] button in the System Menu to call the setup screen shown below.

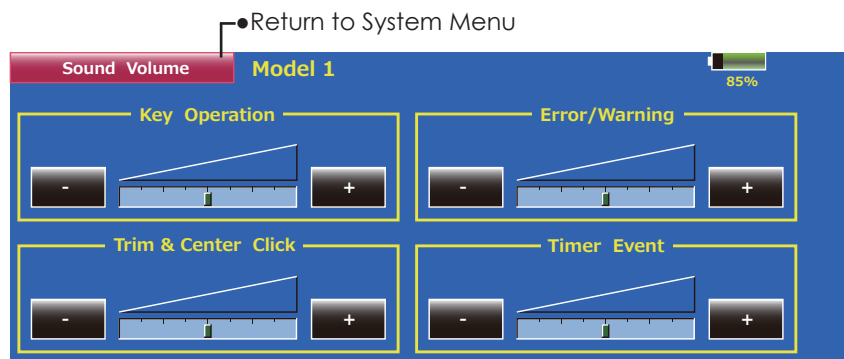

Sound Volume Setting method

1. When the Sound Volume box is touched, the above screen will appear.
2. You can change the sound volume by touching the "+" "-" button of four items.

*If you touch "+", the volume will increase. If you touch the "-", the volume will decrease.

Player

Music playback

The T18MZ transmitter can play back ".wma" music files stored in your SD card and USB memory. You can listen to them through the built-in speaker or through the headphone jack with your own headphones.

[Important notice]

Before downloading files from your PC into the SD card, insert the SD card into the transmitter and turn on the power of the transmitter. Then the following folders will be automatically created in the SD card. When you download files from you PC, copy and paste the files into their corresponding files.

- BMP : picture files
- WMA : music files
- WAV : sound files
- MODEL : model data files

- Push the Music Playback button on the home screen to call the following set-up screen.

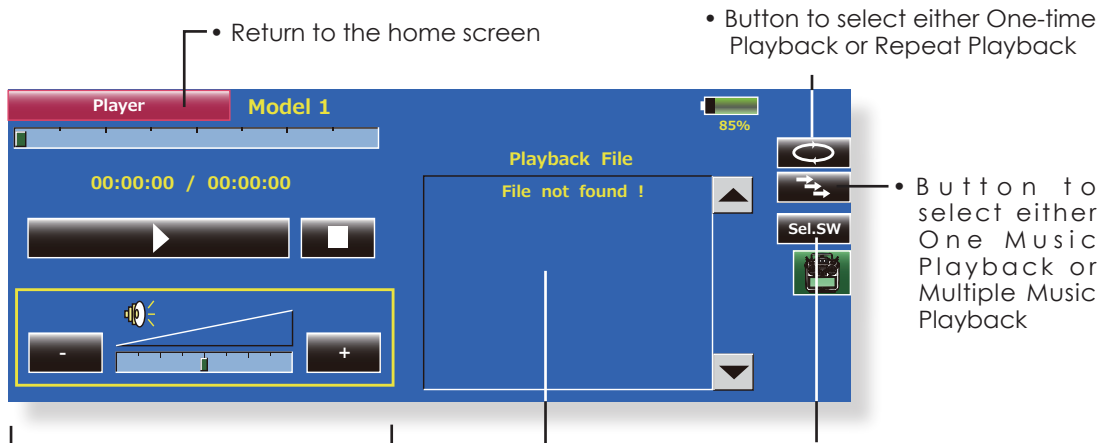

Buttons for music playback

- You can playback any music files listed on the right side of the screen.
- If you adjust the volume here, it adjusts not only music playback but also other applications.

- Return to the home screen
- Button to select either One-time Playback or Repeat Playback
- Button to select either One Music Playback or Multiple Music Playback
- SW selection button
Push this button to call the SW select screen and choose the Music playback switch.
(Refer to the description in the end of this manual)

(Playback file list)

To playback

- All the music files saved in the T18MZ/SD card/USB memory will be shown here.

1. Push the file name to select the music file you want to hear.
2. Use the buttons on the left to playback or stop the music.

Copy / Delete / Rename

1. Data is chosen from Playback File.
2. Selected data is pushed.
3. Copy / Delete / Rename is chosen from a right display.
4. Next, it chooses in [Yes] and [No]. In Rename, name is inputted into the keyboard which appeared, and, finally it pushes Enter.

Camera

Camera photography and picture storage

Pictures can be easily taken with the camera in the T18MZ. The picture can be saved to the T18MZ, SD card, and USB memory. Your favorite model photographed by you can be displayed on the Home screen, Start screen, and Model Select screen.

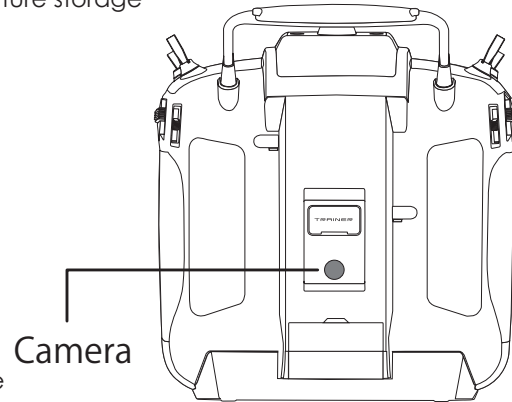

- Call the following setting screen by pressing the [Camera] button in the System Menu.

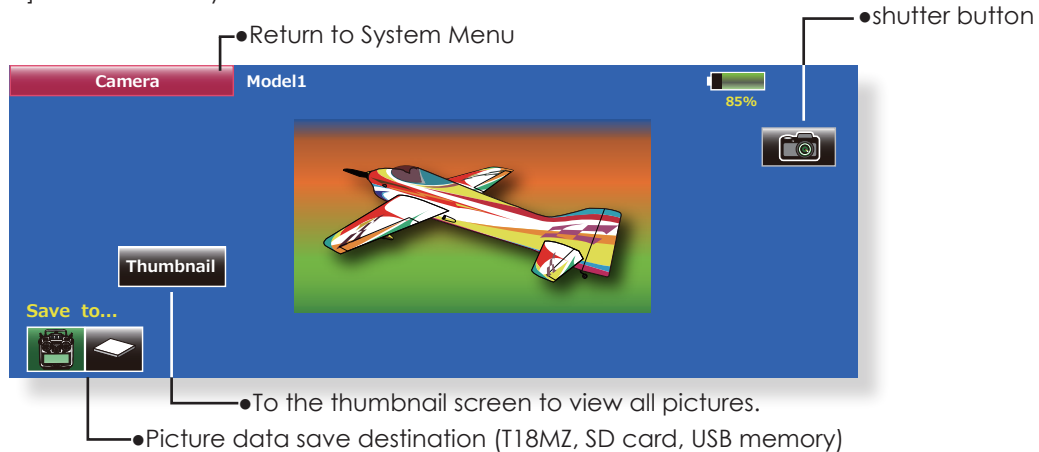

Shooting method

1. Turn on the transmitter and call [Camera] from the System Menu.
2. Select the picture save destination. (T18MZ, SD card, USB memory)
*Only when an SD card and USB memory are used will an icon be displayed and this choice can be selected.
3. Point the camera at the back of the transmitter toward the subject and press the shutter button.
4. The picture can be checked with the [Thumbnail] button. A picture can be copied and deleted by pressing it.

Copy / Delete / Rename

1. [Thumbnail] button is pushed.
2. Data is chosen from Thumbnail.
3. Copy / Delete / Rename is chosen from a right display.
4. Next, it chooses in [Yes] and [No]. In Rename, name is inputted into the keyboard which appeared, and, finally it pushes Enter.

Display pictures at the model data

1. Call [Camera] from the System Menu.
2. Make the save destination the same place as model data. If an SD card or USB memory is not connected, the T18MZ becomes the initial state.
3. Take the picture you want to display with the T18MZ.
(Position the picture inside the frame.)
4. Select the model whose picture you want to paste beforehand.
5. Press [Thumbnail] and then press the picture you took earlier.
6. Press[Entry].
7. The message "Sure?" is displayed. Press [Yes].

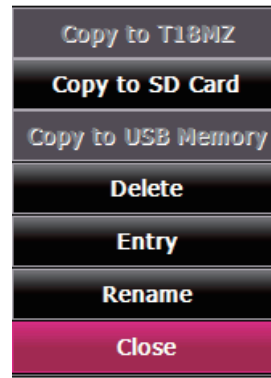

S.BUS Servo

S.BUS servo setting

An S.BUS servo can memorize the channel and various settings itself. Servo setting can be performed on the T18MZ screen by wiring the servo as shown in the figure.

•Servo ID number

Individual ID numbers are memorized for your S.BUS servos in your T18MZ. When a servo is used (as shown at the right), the servo ID number is automatically read by the transmitter.

If you use multiple S.BUS servos and do not want to change the settings on all that are mounted in a fuselage, only the desired servo in the group can be set by entering the ID of that specific servo.

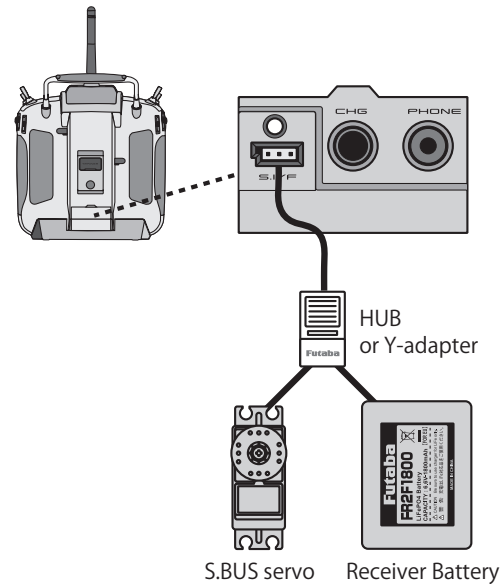

* S9070SB cannot be arranged by T18MZ.

* With S.BUS servos of use, there are a function which can be used, and an impossible function and a display screen changes.

(Only the function which can be used by a servo is displayed.)

- Call the following setting screen by pressing the [S.BUS Servo] button in the System Menu.

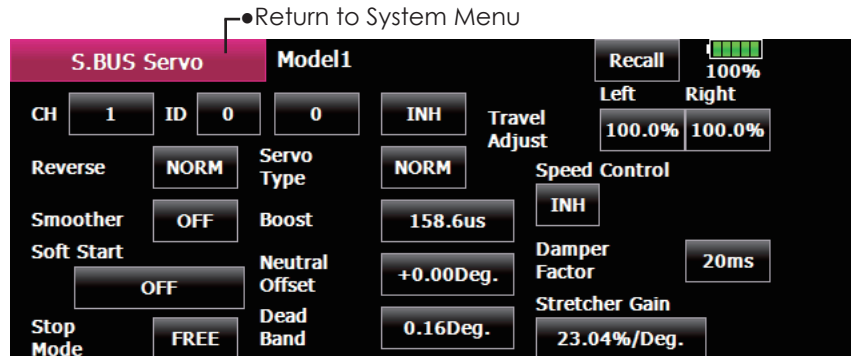

Procedure for changing S.BUS servo setting

1. Select [S.BUS Servo] of the System Menu.
2. Wire the servo as shown in the figure above.
3. Press [Recall]. The ID and current setting of that servo are displayed.
4. When multiple servos are connected change [INH] at the right side of the ID number on the screen to [ACT] and enter the ID of the servo you want to set.
5. Set each item. (Please see the next page.)
6. Press [Write]. The settings are changed.

S.BUS Servo Description of function of each parameter

*There are a function which can be used according to the kind of servo, and an impossible function.

- **ID**

Displays the ID of the servo whose parameters are to be read. It cannot be changed.

- **Channel**

Channel of the S.BUS system assigned to the servo. Always assign a channel before use.

- **Reverse**

The direction in which the servo rotates can be changed.

- **Servo type**

When "Retractable" is selected and the servo has been continuously stopped for 30 seconds, the dead band expands and unnecessary hold current due to external force is eliminated. When a new control signal enters, normal operation is resumed. When using the servo as a landing gear servo, select "Retractable". Also adjust the servo travel to match the landing gear movement range.

- **Soft Start**

Restricts operation in the specified direction the instant the power is turned on. By using this setting, the first initial movement when the power is turned on slowly moves the servo to the specified position.

- **Stop Mode**

The state of the servo when the servo input signal is lost can be specified. The "Hold" mode setting holds the servo in its last commanded position even if using AM or FM system.

- **Smoother**

This function changes smoothness of the servo operation relative to stick movement changes. Smooth setting is used for normal flight. Select the "OFF" mode when quick operation is necessary such as 3D.

- **Neutral Offset**

The neutral position can be changed. When the neutral offset is large value, the servo's range of travel is restricted on one side.

- **Speed Control**

Speeds can be matched by specifying the operating speed. The speed of multiple servos can be matched without being affected by motor fluctuations. This is effective for load torques below the maximum torque.

However, note that the maximum speed will not be exceeded what the servo is capable of even if the servos operating voltage is increased.

- **Dead band**

The dead band angle at stopping can be specified.

[Relationship between dead band set value and servo operation]

Small → Dead band angle is small and the servo is immediately operated by a small signal change.

Large → Dead band angle is large and the servo does not operate at small signal changes.

(Note) If the dead band angle is too small, the servo will operate continuously and the current consumption will increase and the life of the servo will be shortened.

- **Travel Adjust**

The left and right travels centered about the neutral position can be set independently.

- **Boost**

The minimum current applied to the internal motor when starting the servo can be set. Since a small travel does not start the motor, it essentially feels like the dead band was expanded. The motor can be immediately started by adjusting the minimum current which can start the motor.

[Relationship between boost set value and servo operation]

Small → Motor reacts to a minute current and operation becomes smooth.

Large → Initial response improves and output torque increases. However, if the torque is too large, operation will become rough.

• **Boost ON/OFF**

OFF : It is the boost ON at the time of low-speed operation.(In the case of usual)

ON : It is always the boost ON.(When quick operation is hope)

• **Damper**

The characteristic when the servo is stopped can be set.

When smaller than the standard value, the characteristic becomes an overshoot characteristic. If the value is larger than the standard value, the brake is applied before the stop position.

Especially, when a large load is applied, overshoot, etc. are suppressed by inertia and hunting may occur, depending on the conditions. If hunting (phenomena which cause the servo to oscillate) occurs even though the Dead Band, Stretcher, Boost and other parameters are suitable, adjust this parameter to a value larger than the initial value.

[Relationship between damper set value and servo operation]

Small → When you want to overshoot. Set so that hunting does not occur.

Large → When you want to operate so that braking is not applied. However, it will feel like the servo response has worsened.

(Note) If used in the hunting state, not only will the current consumption increase, but the life of the servo will also be shortened.

• **Stretcher**

The servo hold characteristic can be set. The torque which attempts to return the servo to the target position when the current servo position has deviated from the target position can be adjusted.

This is used when stopping hunting, etc., but the holding characteristic changes as shown below.

[Relationship between stretcher and servo operation]

Small → Servo holding force becomes weaker.

Large → Servo holding force becomes stronger.

(Note) When this parameter is large, the current consumption increases.

• **Buzzer**

When the power supply of a servo is previously turned on at the time of a power supply injection without taking transmit of a transmitter, the buzzer sound of about 2.5 Hz continues sounding from a servo.

(Even when the transmit of a transmitter is taken out previously, a buzzer becomes until the signal of a servo is outputted normally, but it is not unusual.)

The transmitter has been turned OFF ahead of a servo power supply → The buzzer sound of about 1.25 Hz continues sounding as servo power supply end failure alarm.

(Do not insert or remove the servo connector while the receiver power is ON. A buzzer may sound by incorrect recognition.)

* Buzzer sound is generated by vibrating the motor of a servo.

Since current is consumed and a servo generates heat, please do not operate the number more than needed or do not continue sounding a buzzer for a long time.

Information

The program version, CF card/USB memory data, and product ID are displayed. The language used by the system can also be changed.

The Information screen displays the T18MZ system program version information, T18MZ ,SD card and USB memory (memory size, vacant capacity, number of model data, and number of music files) information and product ID.

*When an SD card and USB memory are not inserted, their information is not displayed.

- Touch the [Information] button at the System Menu to call the setup screen shown below.

•Return to System Menu

Information		New model-1			100%
Transmitter ID	113000036	Internal memory	SD Card	USB Memory	
Area	America	Memory Size	92 MB	121 MB	0 MB
		Free Space	51 MB	98 MB	0 MB
		Model data	400 models	702 models	0 model
Language		Version			
English		WindowsCE	Ver. 6.0 (0)		
		Editor	Ver. 1.100.0		
		Encoder	Ver. 1.100		

Range Check Before a flight ground range check.

The 'range check mode' reduces the transmission range of the radio waves to allow for a ground range check.

*The range check mode, when activated, will continue for 90 seconds unless the user exits this mode early. When the progress bar reaches 90 second mark, the RF transmission automatically returns to the normal operating power.

- Pushing [S4]Key is continued. → Turn ON the transmitter's power switch
→ [S4]Key will be released if the screen of "Transmit?" comes out.



- [NO] is pushed.

- Touch the [Range Check] button at the System Menu to call the setup screen shown below.

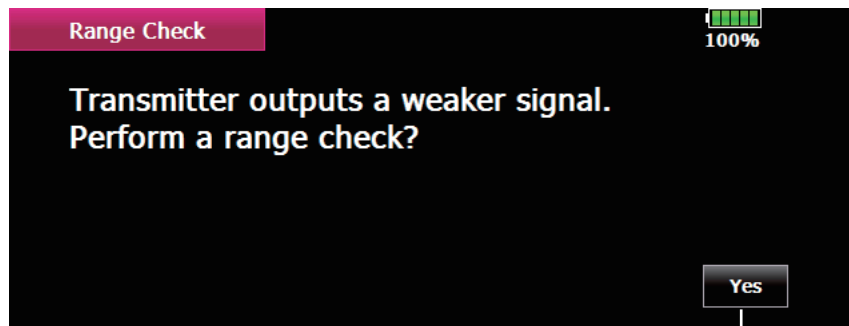

- [Yes] is pushed.

Rotation Range Check method

1. Pushing [S4]Key is continued. → Turn ON the transmitter's power switch. Select [No] .

*For safety, the RANGE CHECK mode can not be selected while the RF transmission is active.

2. In the system menu, choose the 'Range Check' selection from the menu options.

3. The Range Check screen is displayed. To activate the Range Check mode press the [Yes] button. During the Range Check period, the RF power is reduced to allow the ground range tests to be performed.

4. The Range Check function automatically exits after the 90 second time limit has expired. The progress bar is displayed on the transmitter's screen. Should you complete the range check before the 90 seconds has passed, press the [Exit] button.

*When the [RESTART] button is pressed, the range check mode timer is returned to 0.

Warning

- ! Do not fly in the range check mode.

*Since the range of the radio waves is short, if the model is too far from the transmitter, control will be lost and the model will crash.

5. When the [Exit] button is pressed, the Range Check mode is disabled and the 18MZ will begin transmitting at full power.

*After exiting the Range Check mode, the function cannot be selected again. To select the Range Check mode again you must cycle the transmitter power switch.

MODEL BASIC SETTING PROCEDURE

Airplane/glider basic setting procedure

1. Model addition and call

Initial setting assigns one model to the T18MZ transmitter. The Model Select function of the Linkage Menu is used to add models and to select models which have already been set.

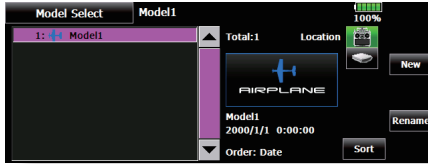

This is convenient when calling a model after its name has been registered. (Data can also be saved to the accessory SD card and USB memory)

The currently called model name is displayed at the top of the screen. Before flying and before changing any settings, always confirm the model name.

When a new model was added, the Model type select screen/System Type/Receiver link automatically appear. Please be aware that the transmitter will stop transmitting when you change the model.

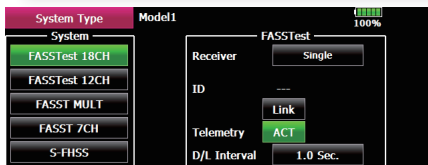
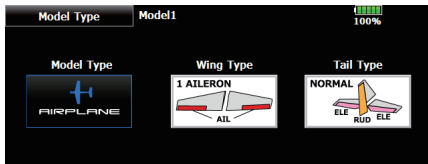

2. Model type selection

Select the model type matched to the fuselage with the Model Type select function of the Linkage Menu. For an airplane, select the model type from among the 3 types: airplane, glider, and motor glider. When the Wing type select screen is displayed and the wing type is selected when selecting the model type, the Tail type select screen is displayed. Select the tail type matched to the fuselage.

There are 13 wing types and 3 tail types for airplane, glider, and motor glider.

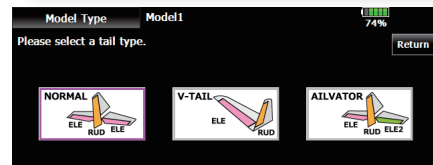
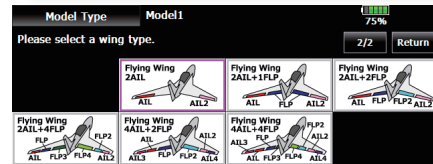
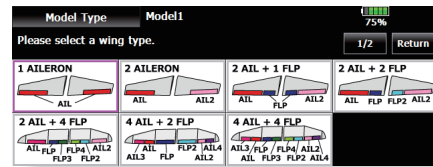

3. Fuselage linkage

Link the ailerons, elevators, throttle, rudder, etc. in accordance with the model's instruction manual. For a description of the connection method, see the Receiver and Servos Connection.

Note: The channel assignment of the T18MZ is different from that of our existing systems. Note that even for the same "airplane model", when the wing type and tail type are different, the channel assignment have been optimized and may be different. (The channel assigned to each function can be checked in the Function menu of the Linkage Menu.)

CH	Function	Control	Trim	CH	Function	Control	Trim
1	Aileron	J1	T1	7	Auxiliary1	NULL	NULL
2	Elevator	J3	T3	8	Auxiliary2	NULL	NULL
3	Throttle	J2	T2	9	Auxiliary3	NULL	NULL
4	Rudder	J4	T4	10	Auxiliary4	NULL	NULL
5	Air Brake	RST	NULL	11	Auxiliary5	NULL	NULL
6	Gear	SG	NULL	12	Auxiliary6	NULL	NULL

- When the direction of the linkage is reversed, adjust the direction with the Servo Reverse function in the Linkage Menu.

CH	Function	Setting	CH	Function	Setting	CH	Function	Setting
1	Aileron	NORM	7	Auxiliary5	NORM	13	Auxiliary1	NORM
2	Elevator	NORM	8	Auxiliary4	NORM	14	Auxiliary1	NORM
3	Throttle	NORM	9	Auxiliary3	NORM	15	Auxiliary1	NORM
4	Rudder	NORM	10	Auxiliary2	NORM	16	Auxiliary1	NORM
5	Gear	NORM	11	Auxiliary1	NORM			DG1
6	Air Brake	NORM	12	Auxiliary1	NORM			DG2

- Connect the throttle linkage so the carburetor is open at full trim and full open so that the throttle can be cut.
- Adjust the neutral position and rudder angle with the linkage, and fine tune them with the Sub Trim and End Point functions (rudder angle adjustment). To protect the linkage, a limit position can also be set with the End Point function. The End Point function can adjust the amount of up/down and left/right movement, limit, and servo speed of each channel.

4. Throttle cut setting

Throttle cut can be performed with one touch by a switch without changing the throttle trim position.

Set throttle cut with the Throttle Cut function of the Linkage Menu. After activating the throttle cut function and selecting the switch, adjust the throttle position so that the carburetor becomes full open. For safety, the throttle cut function operates the throttle stick in the slow position.

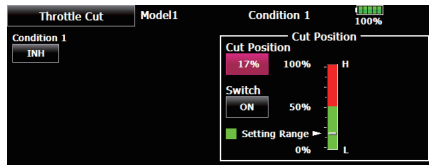

5. Idle down setting

The idling speed can be lowered with one touch by a switch without changing the throttle trim position. Perform this setting with the Idle Down function of the Linkage Menu. After activating the Idle Down function and selecting the switch, adjust the idle down speed. For safety, the idle down function acts only when the throttle stick is in the slow position.

*While the Throttle Cut function is in operation, the Idle Down function does not work.

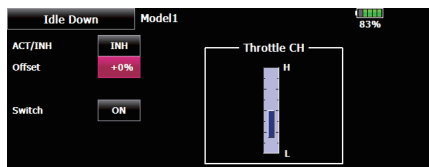

6. AFR (D/R)

AFR function is used to adjust the throw and operation curve of the stick, lever, and switch functions for each flight condition. This is normally used after End Point (ATV) has defined the maximum throw directions (End Point acts on ALL flight condition settings). When mixing is applied from one channel to another channel, both channels can be adjusted at the same time by adjusting the operation rate through the AFR function.

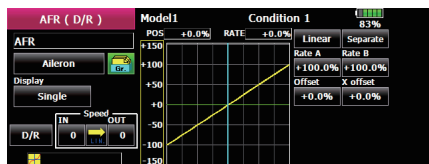

7. Airbrake

This function is used when an air brake is necessary when taking off or diving, etc.

The preset elevators and flaps (camber flap, brake flap) offset amount can be activated by a switch.

The offset amount of the aileron, elevator, and flap servos can be adjusted as needed. Also the speed of the aileron, elevator, and flap servos can be adjusted. (IN side/OUT side) A delay can be set for each condition, and a Cut switch which will turn OFF the delay can be chosen. The VR (Variable Rate) function can be used for adjusting a VR. The Airbrake function can be used for adjusting the stick ch.



8. Addition of flight conditions

The transmitter can install up to eight flight conditions per model. You can assign all switches including sticks, switches, trim levers and trim switches as flight-condition selection switches. You can also add delayed mixing to these functions in order to avoid sudden changes. Moreover, you can set priority order for flight conditions when you set more than one condition. In addition, you can copy conditions and/or change names of conditions. This command may also be used to define what switches and/or controls are used to activate each flight condition.

The Condition Select function automatically allocates the Condition 1 for each model type. Condition 1 is the default condition, also referred to as Normal, and is the only one active when a new model type is defined. This condition is always on, and remains on until other conditions are activated by switches.

The Condition Delay can be programmed for each channel. The Condition Delay is used to change the servo throw smoothly when switching conditions.

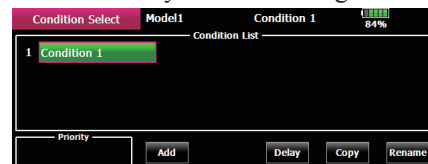

*When a new condition is added, "Condition1" data is automatically copied.

*Select the condition switch and set the new condition data with the switch in the ON position. However, if the group mode (Gr.) was selected in advance, the same data will be input to all new conditions. Select the single mode (Sngl) and adjust the condition you want to change.

Helicopter basic setting procedure

1. Model addition and call

Default settings assign one model to the T18MZ transmitter. To add new models or select previously setup models, use the Model Select function in the Linkage Menu.

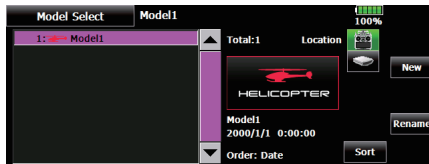

This is convenient when calling a model after registering the model names in advance. (Data can also be saved to the accessory SD card and USB memory)

The currently called model is displayed at the top of the screen. Before flying and before changing any settings, always confirm the model name.

Please be aware that the transmitter will stop transmitting when you change the model.

When a new model was added, the Model type select screen/System mode/Receiver link automatically appear. Please be aware that the transmitter will stop transmitting when you change the model.

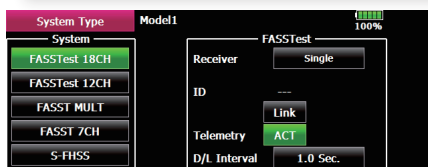
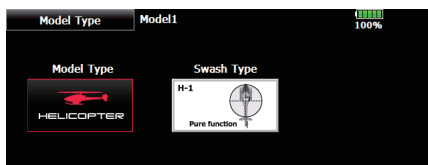

2. Model type and swash type selection

When a separate model type is already selected, select helicopter with the Model Type function of the Linkage Menu, and then select the swash type matched to the fuselage.

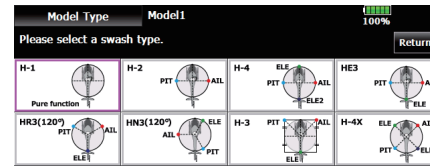
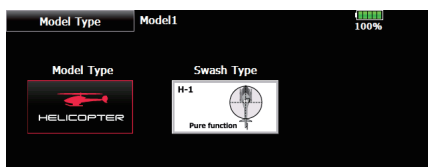

3. Flight condition addition

The transmitter can install up to eight flight conditions per model. You can assign all switches including sticks, switches, trim levers and trim switches as flight-condition selection switches. You can also add delayed mixing to these functions in order to avoid sudden changes. Moreover, you can set priority order for flight conditions when you set more than one condition. In addition, you can copy conditions and/or change names of conditions. This command may also be used to define what switches and/or controls are used to activate each flight condition.

The Condition Select function automatically allocates the default Condition 0 (Normal) for each model type. Condition 0 (Normal) is the only one active when a new model type is defined. This condition is always on, and remains on until other conditions are activated by switches.

The Condition Delay can be programmed for each channel. The Condition Delay is used to change the servo throw smoothly when switching conditions.

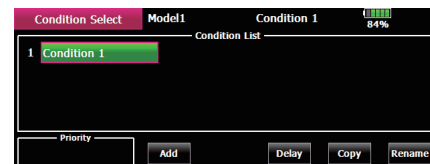

(General flight condition setting example)

- Normal: (Use initial setting conditions/operate when switch OFF)
Use from engine starting to hovering.
- Idle up 1: (Switch setting example: Operate at SW-E center)
Use in stall turn, loop, and other maneuvers.
- Idle up 2: (Switch setting example: Operate at SW-E forward side)
Use in rolls.
- Throttle hold: (Switch setting example: Operate at SW-G forward side)
Use in auto rotation.

The priority is throttle hold/idle up 2/idle up 1/normal. Throttle hold has the highest priority.

Add other conditions, as required.

4. Fuselage linkage

Connect the throttle rudder, ailerons, elevators, pitch, and other rudder linkages in accordance with the kit instruction manual. For a description of the connection method, see "Receiver and Servos Connection".

*The channel assignment of the T18MZ is different from that of our existing systems. (The channel assigned to each function can be checked at the Function menu of the Linkage Menu.)

CH	Function	Control	Trim	CH	Function	Control	Trim
1	Aileron	J1	T1	7	Governor	NULL	NULL
2	Elevator	J3	T3	8	Governor2	NULL	NULL
3	Throttle	J2	T2	9	Needle	LST	NULL
4	Rudder	J4	T4	10	Gyro2(AIL)	NULL	NULL
5	Gyro(RUD)	NULL	NULL	11	Gyro3(ELE)	NULL	NULL
6	Pitch	J2	NULL	12	Auxiliary1	NULL	NULL

- When the direction of the linkage is reversed, use the Reverse function of the Linkage Menu. Also use the swash AFR function in any swash set up other than the H-1 mode.

CH	Function	Setting	CH	Function	Setting	CH	Function	Setting
1	Aileron	NORM	7	Governor	NORM	13	Auxiliary2	NORM
2	Elevator	NORM	8	Governor2	NORM	14	Auxiliary3	NORM
3	Throttle	NORM	9	Needle	NORM	15	Auxiliary4	NORM
4	Rudder	NORM	10	Gyro2(AIL)	NORM	16	Auxiliary5	NORM
5	Gyro(RUD)	NORM	11	Gyro3(ELE)	NORM	DG1		NORM
6	Pitch	NORM	12	Auxiliary1	NORM	DG2		NORM

- Adjust the direction of operation of the gyro. (Gyro side function)
- Connect the throttle linkage so that the carburetor becomes full open at full trim throttle cut is possible.
- Adjust the neutral position and rudder angle at the linkage side and fine tune with the Sub-Trim function and End Point function (rudder angle adjustment). To protect the linkage, a limit position can also be set with the End Point function.

CH	Function	Limit	Travel	CH	Function	Limit	Travel
1	Aileron	135%	100%	100%	135%	0	0
2	Elevator	135%	100%	100%	135%	0	0
3	Throttle	135%	100%	100%	135%	0	0
4	Rudder	135%	100%	100%	135%	0	0
5	Gyro(RUD)	135%	100%	100%	135%	0	0
6	Pitch	135%	100%	100%	135%	0	0

CH	Function	Limit	Travel	CH	Function	Limit	Travel
1	Aileron	135%	100%	100%	135%	0	0
2	Elevator	135%	100%	100%	135%	0	0
3	Throttle	135%	100%	100%	135%	0	0
4	Rudder	135%	100%	100%	135%	0	0
5	Gyro(RUD)	135%	100%	100%	135%	0	0
6	Pitch	135%	100%	100%	135%	0	0

- Swash plate correction (Except H-1 mode)
Operation of the swash plate near the hovering point can be corrected by swash AFR function correction mixing. Use this when pitch, aileron, and elevator operation causes the swash plate to deviate from the normal direction.

(Call the Swash setup→Swash details screen.)
Pitch slow side and high side linkage correction is also possible. Adjust so that pitch operation causes the swash plate to move up and down in the horizontal state.

5. Throttle curve setting

This function adjusts the pitch operation curve in relation to the movement of the throttle stick for each condition.

(17 points curve)

The pitch curve can be freely selected from linear operation curve to smooth curve, and adjusted to match the curve you want by means of the T18MZ's powerful Curve Edit Function (6 types of curves can be selected). Up to 17 points can be set for linear or curve types. However, when using the 3 points or 5 points specified to create a curve, a simple and smooth curve can be created by selecting the curve type and reducing the number of input points to 3 or 5, and then entering the specified value at the corresponding points that you created.

<Setting example>

Call the throttle curve of each condition with the condition select switch.

- Normal curve adjustment
Normal curve uses Normal (Linear) type and creates a basic pitch curve centered near hovering. This curve is adjusted together with the Throttle Curve (Normal) so that the engine speed is constant and up/down control is easiest.
- Idle up curve adjustment
The high side pitch curve sets the maximum pitch regardless of the engine load. The low side pitch curve creates a curve matched for aerobatics (loop, roll, 3D, etc.).

Note: When the curve type is changed, the data is reset.

- **Throttle hold curve adjustment**
The throttle hold curve is used when performing auto rotation dives.
Confirm that the rate of the slowest position (0%) of the stick is 0% (initial setting).
Be sure that when set to high side 100%, the curve of any condition does not exceed 100%.

Example of pitch curve setting:

1. Call the pitch curve of each condition with the condition select switch.
*Pitch curve graph display can be switched to pitch angle direct reading display.
- A. Pitch curve (Normal)
Make the pitch at hovering approximately +5°~6°. Set the pitch at hovering with the stick position at the 50% point as the standard.
*Stability at hovering may be connected to the throttle curve. Adjustment is easy by using the hovering throttle function and hovering pitch function together.
- B. Pitch curve (Idle up 1)
The idle up 1 pitch curve function creates a curve matched to airborne flight. Set to -7°~+12° as standard.
- C. Pitch curve (Idle up 2)
The high side pitch setting is less than idle up 1. The standard is +8°.
- D. Pitch curve (Hold)
At auto rotation, use the maximum pitch at both the high and low sides.
[Pitch angle setting example]
Throttle hold: -7°~+12°

6. Throttle hold setting

Call the Throttle Hold function from the Model Menu and switch to the throttle hold condition with the condition select switch.

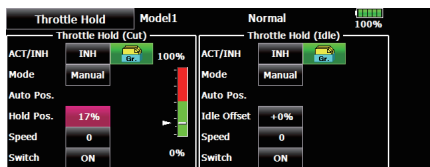

Note: At initial setting, the setting mode is the group mode. Since this function is not used at other conditions, switch to the single mode before setting.

- **Setting to the state which activates the function**
The throttle hold function allows setting for throttle cut and switching of the function fixed at the idle position by switch for training. Either one or both functions can be performed.
- **Hold position setting**
This function sets the servo operation position at throttle hold. (Throttle cut and idle positions)
- **Other settings**
When you want to link operation with stick

manipulation, the Auto mode can be set. When you want to adjust the servo speed, adjust [Speed].

7. Pitch to RUD mixing setting

Use this function when you want to suppress the torque generated by the changes in the pitch and speed of the main rotor during pitch operation. Adjust it so that the nose does not swing in the rudder direction. However, when using a heading hold gyro like those shown below, do not use Pitch to RUD mixing.

Note: When using a GY701, GY601, GY502, GY401, or other heading hold gyro, this Pitch to RUD mixing should not be used. The reaction torque is corrected at the gyro side. When operating the gyro in the AVCS mode, the mixed signal will cause neutral deviation symptoms and the gyro will not operate normally.

Call the Pitch to RUD mixing function from the Model Menu, and set the curve for each condition. (At initial setting, this function is in the "INH" state. To use it, set it to the "ON" state.)

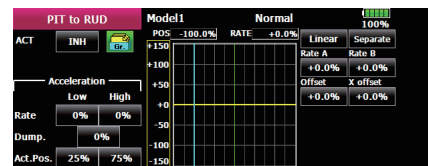

(17 points curve)

Curve setting of up to 17 points is possible. However, in the following setting example, a simple curve can be adjusted by using the [Linear] curve type.

Note: At initial setting, the setting mode is the group mode. In this mode, the same contents are set at in all conditions. When you want to set the selected condition only, switch to the single mode.

<Setting example>

Call the mixing curve of each condition with the condition select switch.

1. A curve setting example is shown below.

A. Pitch to RUD mixing curve (Normal)

Use the hovering system and set this curve to match take off and landing and vertical climb at a constant speed.

*For this curve, use the initial setting [Linear] curve type and adjust the left and right rates in the [Separate] mode.

B. Pitch to RUD mixing (Idle up 1)

Use this curve in stall turn, loop, and adjust it so the fuselage is facing straight ahead when heading into the wind.

*For this curve, [Linear] curve type can be used and the entire curve can be lowered with the [Offset] button.

C. Pitch to RUD mixing (Hold)

This function is set so that the fuselage is facing straight ahead during straight line auto rotation. The pitch of the tail rotor becomes nearly 0°.

*For this curve, [Linear] curve type can be used and the entire curve can be lowered with the [Offset] button.

•Other settings

The mixing rise characteristic of pitch operation can be adjusted. An acceleration (ACLR) function, which temporarily increases and decreases the mixing amount, can be set.

8. Swash Mix corrects aileron, elevator and pitch interaction

The swash mix function is used to correct the swash plate in the aileron (roll) direction and elevator (cyclic pitch) corresponding to each operation of each condition.

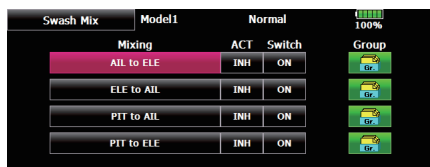

9. Throttle mixing setting

RPM loss caused by swash operation of aileron or elevator can be corrected with the Throttle Mix function in the Model Menu. The effects of clockwise and counterclockwise torque is applied when pirouetting can also be corrected.

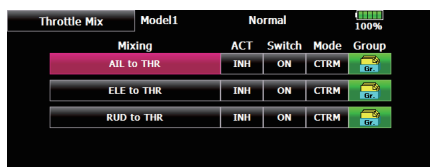

10. Gyro sensitivity and mode switching

The gyro sensitivity and mode switching function is dedicated gyro mixing of the Model Menu, and can be set for each condition.

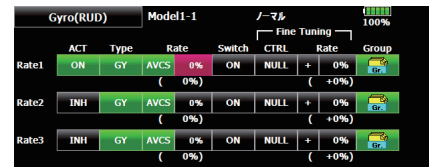

- Normal condition (hovering): Gyro sensitivity maximum
- Idle up 1/Idle up 2/Throttle hold: Gyro sensitivity minimum
- However, at auto rotation of a tail-driven helicopter, this function may not have any affect at high gyro sensitivity.

11. Throttle cut setting

Throttle cut provides an easy way to stop the engine, by flipping a switch with the throttle stick at idle. The action is not functional at high throttle to avoid accidental dead sticks. The switch's location and direction must be chosen, as it defaults to NULL.

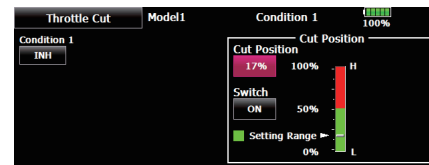

*With throttle stick at idle, adjust the cut position until the engine consistently shuts off, but throttle linkage is not binding. When finished, touch the "Throttle Cut" button to exit.

12. Other special mixings

- Pitch to Needle mixing
This mixing is used with engines with a construction which allows needle control during flight (fuel-air mixture adjustment). A needle curve can be set. The needle servo rise characteristics at throttle stick acceleration/deceleration operation can be adjusted. (Acceleration function)
- Fuel mixture function
This mixing is used in needle adjustment of engines which use a fuel mixture control carburetor.
- Governor mixing
This mixing is dedicated governor mixing when a governor is used. Up to 3 rates (speeds) can be switched for each condition.

Receiver and servos connection

Connect the receiver and servos in accordance with the connection diagram shown below. Always read [Precautions when mounting the receiver and servos] and [Before using]. When mounting the receiver and servos to the fuselage, connect the necessary points in accordance with the kit instruction manual.

Receiver and servos connection diagram

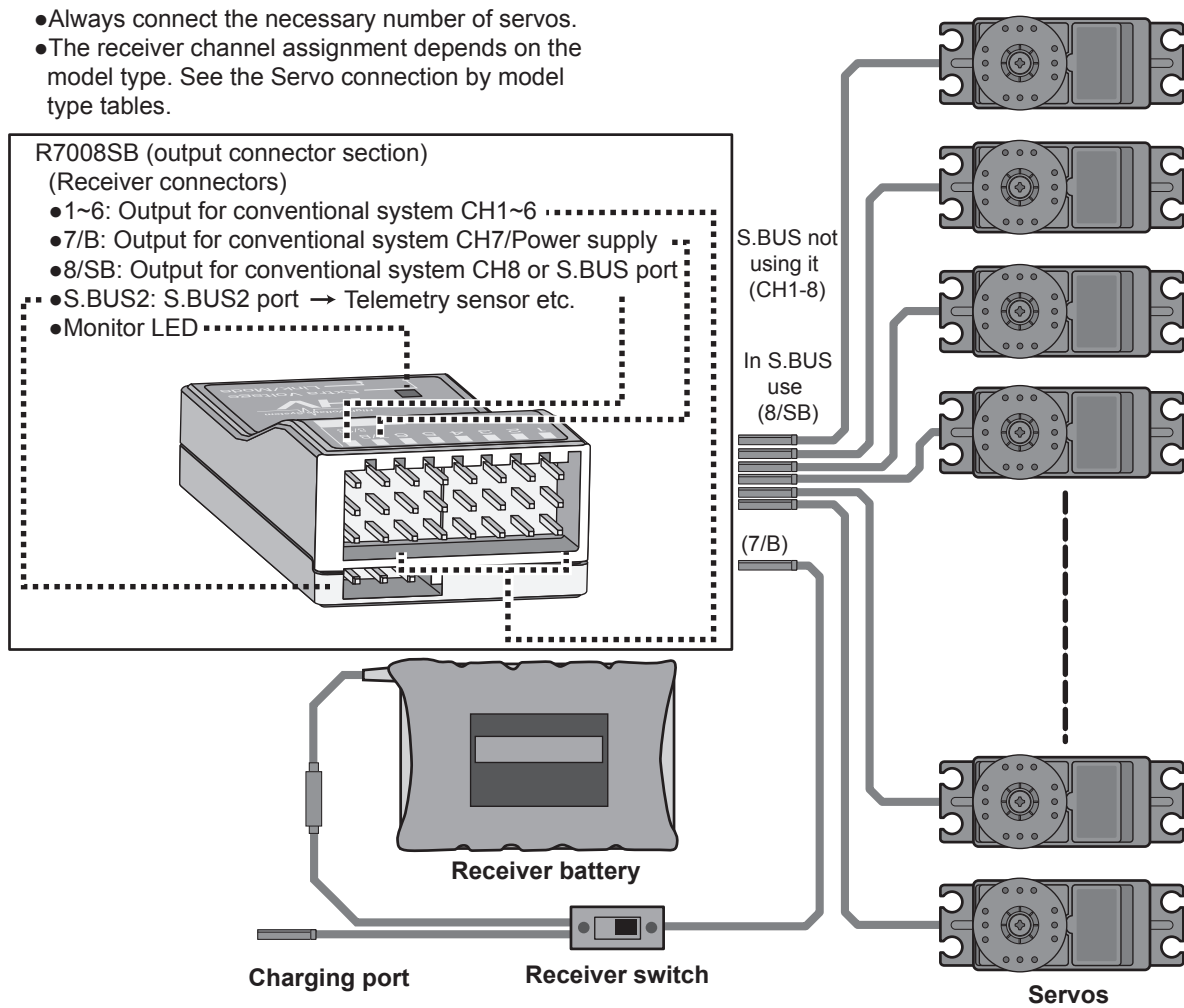

- The Servo connection by model type tables are shown on the following pages. Connect the servos to match the fuselage used.

Servo connection by model type

The T18MZ transmitter channels are automatically assigned for optimal combination according to the type selected with the Model Type function of the Linkage Menu. The channel assignment (initial setting) for each model type is shown below. Connect the receiver and servos to match the type used.

*The set channels can be checked at the Function screen of the Linkage Menu. The channel assignments can also be changed. For more information, read the description of the Function menu.

Airplane/glider/motor glider

•Airplane and V tail

RX CH	1AIL			2AIL			2AIL+1FLAP			2AIL+2FLAP			The output CH of each system ↓ S-FHSS FASSTest 12CH FASST 7CH FASSTest 18CH FASSTest 12CH FASST MULT
	Airplane	Glider		Airplane	Glider		Airplane	Glider		Airplane	Glider		
		EP			EP			EP			EP		
1	Aileron	Aileron	Aileron	Aileron	Aileron	Aileron	Aileron	Aileron	Aileron	Aileron	Aileron	Aileron	
2	Elevator	Elevator	Elevator	Elevator	Elevator	Elevator	Elevator	Elevator	Elevator	Elevator	Elevator	Elevator	
3	Throttle	Motor	AUX7	Throttle	Motor	AUX7	Throttle	Motor	AUX7	Throttle	Motor	AUX7	
4	Rudder	Rudder	Rudder	Rudder	Rudder	Rudder	Rudder	Rudder	Rudder	Rudder	Rudder	Rudder	
5	Gear	AUX6	AUX6	Gear	AUX6	AUX6	Gear	AUX6	AUX6	Aileron2	Aileron2	Aileron2	
6	Airbrake	Airbrake	Airbrake	Aileron2	Aileron2	Aileron2	Aileron2	Aileron2	Aileron2	Flap	Flap	Flap	
7	AUX5	AUX5	AUX5	AUX5	AUX5	AUX5	Flap	Flap	Flap	Flap2	Flap2	Flap2	
8	AUX4	AUX4	AUX4	AUX4	AUX4	AUX4	AUX5	AUX5	AUX5	Gear	AUX6	AUX6	
9	AUX3	AUX3	AUX3	AUX3	AUX3	AUX3	AUX4	AUX4	AUX4	AUX5	AUX5	AUX5	
10	AUX2	AUX2	AUX2	AUX2	AUX2	AUX2	AUX3	AUX3	AUX3	AUX4	AUX4	AUX4	
11	AUX1	AUX1	AUX1	AUX1	AUX1	AUX1	AUX2	AUX2	AUX2	AUX3	AUX3	AUX3	
12	AUX1	AUX1	AUX1	AUX1	AUX1	AUX1	AUX1	AUX1	AUX1	AUX2	AUX2	AUX2	
13	AUX1	AUX1	AUX1	AUX1	AUX1	AUX1	AUX1	AUX1	AUX1	AUX1	AUX1	AUX1	
14	AUX1	AUX1	AUX1	AUX1	AUX1	AUX1	AUX1	AUX1	AUX1	AUX1	AUX1	AUX1	
15	AUX1	AUX1	AUX1	AUX1	Butterfly	Butterfly	AUX1	Butterfly	Butterfly	AUX1	Butterfly	Butterfly	
16	AUX1	AUX1	AUX1	Camber	Camber	Camber	Camber	Camber	Camber	Camber	Camber	Camber	
DG1	SW	SW	SW	SW	SW	SW	SW	SW	SW	SW	SW	SW	
DG2	SW	SW	SW	SW	SW	SW	SW	SW	SW	SW	SW	SW	

RX CH	2AIL+4FLAP			4AIL+2FLAP			4AIL+4FLAP			The output CH of each system ↓ S-FHSS FASSTest 12CH FASST 7CH FASSTest 18CH FASSTest 12CH FASST MULT
	Airplane	Glider		Airplane	Glider		Airplane	Glider		
		EP			EP			EP		
1	Aileron	Aileron	Aileron	Aileron	Aileron	Aileron	Aileron	Aileron	Aileron	
2	Elevator	Elevator	Elevator	Elevator	Elevator	Elevator	Elevator	Elevator	Elevator	
3	Throttle	Rudder	Rudder	Throttle	Rudder	Rudder	Throttle	Rudder	Rudder	
4	Rudder	Aileron2	Aileron2	Rudder	Aileron2	Aileron2	Rudder	Aileron2	Aileron2	
5	Gear	Flap	Flap	Gear	Aileron3	Aileron3	Gear	Aileron3	Aileron3	
6	Aileron2	Flap2	Flap2	Aileron2	Aileron4	Aileron4	Aileron2	Aileron4	Aileron4	
7	Flap	Flap3	Flap3	Aileron3	Flap	Flap	Aileron3	Flap	Flap	
8	Flap2	Flap4	Flap4	Aileron4	Flap2	Flap2	Aileron4	Flap2	Flap2	
9	Flap3	Motor	AUX7	Flap	Motor	AUX7	Flap	Flap3	Flap3	
10	Flap4	AUX6	AUX6	Flap2	AUX6	AUX6	Flap2	Flap4	Flap4	
11	AUX5	AUX5	AUX5	AUX5	AUX5	AUX5	Flap3	Motor	AUX7	
12	AUX4	AUX4	AUX4	AUX4	AUX4	AUX4	Flap4	AUX6	AUX6	
13	AUX3	AUX3	AUX3	AUX3	AUX3	AUX3	AUX5	AUX5	AUX5	
14	AUX2	AUX2	AUX2	AUX2	AUX2	AUX2	AUX4	AUX4	AUX4	
15	AUX1	Butterfly	Butterfly	AUX1	Butterfly	Butterfly	AUX3	Butterfly	Butterfly	
16	Camber	Camber	Camber	Camber	Camber	Camber	Camber	Camber	Camber	
DG1	SW	SW	SW	SW	SW	SW	SW	SW	SW	
DG2	SW	SW	SW	SW	SW	SW	SW	SW	SW	

•Ailevator

RX CH	1AIL			2AIL			2AIL+1FLAP			2AIL+2FLAP		
	Airplane	Glider		Airplane	Glider		Airplane	Glider		Airplane	Glider	
		EP			EP			EP			EP	
1	Aileron	Aileron	Aileron	Aileron	Aileron	Aileron	Aileron	Aileron	Aileron	Aileron	Aileron	Aileron
2	Elevator	Elevator	Elevator	Elevator	Elevator	Elevator	Elevator	Elevator	Elevator	Elevator	Elevator	Elevator
3	Throttle	Motor	AUX7	Throttle	Motor	AUX7	Throttle	Motor	AUX7	Throttle	Motor	AUX7
4	Rudder	Rudder	Rudder	Rudder	Rudder	Rudder	Rudder	Rudder	Rudder	Rudder	Rudder	Rudder
5	Gear	AUX6	AUX6	Gear	AUX6	AUX6	Elevator2	Elevator2	Elevator2	Elevator2	Elevator2	Elevator2
6	Airbrake	Airbrake	Airbrake	Aileron2	Aileron2	Aileron2	Aileron2	Aileron2	Aileron2	Aileron2	Aileron2	Aileron2
7	Elevator2	Elevator2	Elevator2	Elevator2	Elevator2	Elevator2	Flap	Flap	Flap	Flap	Flap	Flap
8	AUX5	AUX5	AUX5	AUX5	AUX5	AUX5	Gear	AUX6	AUX6	Flap2	Flap2	Flap2
9	AUX4	AUX4	AUX4	AUX4	AUX4	AUX4	AUX5	AUX5	AUX5	Gear	AUX6	AUX6
10	AUX3	AUX3	AUX3	AUX3	AUX3	AUX3	AUX4	AUX4	AUX4	AUX5	AUX5	AUX5
11	AUX2	AUX2	AUX2	AUX2	AUX2	AUX2	AUX3	AUX3	AUX3	AUX4	AUX4	AUX4
12	AUX1	AUX1	AUX1	AUX1	AUX1	AUX1	AUX2	AUX2	AUX2	AUX3	AUX3	AUX3
13	AUX1	AUX1	AUX1	AUX1	AUX1	AUX1	AUX1	AUX1	AUX1	AUX2	AUX2	AUX2
14	AUX1	AUX1	AUX1	AUX1	AUX1	AUX1	AUX1	AUX1	AUX1	AUX1	AUX1	AUX1
15	AUX1	AUX1	AUX1	AUX1	Butterfly	Butterfly	AUX1	Butterfly	Butterfly	AUX1	Butterfly	Butterfly
16	AUX1	AUX1	AUX1	Camber	Camber	Camber	Camber	Camber	Camber	Camber	Camber	Camber
DG1	SW	SW	SW	SW	SW	SW	SW	SW	SW	SW	SW	SW
DG2	SW	SW	SW	SW	SW	SW	SW	SW	SW	SW	SW	SW

The output
CH of each
system

FASTest 18CH
FASTest 12CH
FAST 7CH

FASTest 18CH
FASTest 12CH
FAST 7CH

FASTest 18CH
FASTest 12CH
FAST 7CH

RX CH	2AIL+4FLAP			4AIL+2FLAP			4AIL+4FLAP		
	Airplane	Glider		Airplane	Glider		Airplane	Glider	
		EP			EP			EP	
1	Aileron	Aileron	Aileron	Aileron	Aileron	Aileron	Aileron	Aileron	Aileron
2	Elevator	Elevator	Elevator	Elevator	Elevator	Elevator	Elevator	Elevator	Elevator
3	Throttle	Motor	AUX7	Throttle	Motor	AUX7	Throttle	Motor	AUX7
4	Rudder	Rudder	Rudder	Rudder	Rudder	Rudder	Rudder	Rudder	Rudder
5	Elevator2	Elevator2	Elevator2	Elevator2	Elevator2	Elevator2	Elevator2	Elevator2	Elevator2
6	Aileron2	Aileron2	Aileron2	Aileron2	Aileron2	Aileron2	Aileron2	Aileron2	Aileron2
7	Flap	Flap	Flap	Aileron3	Aileron3	Aileron3	Aileron3	Aileron3	Aileron3
8	Flap2	Flap2	Flap2	Aileron4	Aileron4	Aileron4	Aileron4	Aileron4	Aileron4
9	Flap3	Flap3	Flap3	Flap	Flap	Flap	Flap	Flap	Flap
10	Flap4	Flap4	Flap4	Flap2	Flap2	Flap2	Flap2	Flap2	Flap2
11	Gear	AUX6	AUX6	Gear	AUX6	AUX6	Flap3	Flap3	Flap3
12	AUX5	AUX5	AUX5	AUX5	AUX5	AUX5	Flap4	Flap4	Flap4
13	AUX4	AUX4	AUX4	AUX4	AUX4	AUX4	Gear	AUX6	AUX6
14	AUX3	AUX3	AUX3	AUX3	AUX3	AUX3	AUX5	AUX5	AUX5
15	AUX2	Butterfly	Butterfly	AUX2	Butterfly	Butterfly	AUX4	Butterfly	Butterfly
16	Camber	Camber	Camber	Camber	Camber	Camber	Camber	Camber	Camber
DG1	SW	SW	SW	SW	SW	SW	SW	SW	SW
DG2	SW	SW	SW	SW	SW	SW	SW	SW	SW

The output
CH of each
system

FASTest 18CH
FASTest 12CH
FAST 7CH

FASTest 18CH
FASTest 12CH
FAST 7CH

FASTest 18CH
FASTest 12CH
FAST 7CH

•Tailless wing

RX CH	2AIL			2AIL+1FLAP			2AIL+2FLAP		
	Airplane	Glider		Airplane	Glider		Airplane	Glider	
		EP			EP			EP	
1	Aileron	Aileron	Aileron	Aileron	Aileron	Aileron	Aileron	Aileron	Aileron
2	AUX4	AUX4	AUX4	AUX4	AUX4	AUX4	AUX4	AUX4	AUX4
3	Throttle	Motor	AUX7	Throttle	Motor	AUX7	Throttle	Motor	AUX7
4	Rudder	Rudder	Rudder	Rudder	Rudder	Rudder	Rudder	Rudder	Rudder
5	Gear	AUX6	AUX6	Gear	AUX6	AUX6	Aileron2	Aileron2	Aileron2
6	Aileron2	Aileron2	Aileron2	Aileron2	Aileron2	Aileron2	Flap	Flap	Flap
7	AUX5	AUX5	AUX5	Flap	Flap	Flap	Flap2	Flap2	Flap2
8	AUX3	AUX3	AUX3	AUX5	AUX5	AUX5	Gear	AUX6	AUX6
9	AUX2	AUX2	AUX2	AUX3	AUX3	AUX3	AUX5	AUX5	AUX5
10	AUX1	AUX1	AUX1	AUX2	AUX2	AUX2	AUX3	AUX3	AUX3
11	AUX1	AUX1	AUX1	AUX1	AUX1	AUX1	AUX2	AUX2	AUX2
12	AUX1	AUX1	AUX1	AUX1	AUX1	AUX1	AUX1	AUX1	AUX1
13	AUX1	AUX1	AUX1	AUX1	AUX1	AUX1	AUX1	AUX1	AUX1
14	AUX1	AUX1	AUX1	AUX1	Butterfly	Butterfly	AUX1	Butterfly	Butterfly
15	Camber	Camber	Camber	Camber	Camber	Camber	Camber	Camber	Camber
16	Elevator	Elevator	Elevator	Elevator	Elevator	Elevator	Elevator	Elevator	Elevator
DG1	SW	SW	SW	SW	SW	SW	SW	SW	SW
DG2	SW	SW	SW	SW	SW	SW	SW	SW	SW

The output
CH of each
system

FASTest 18CH
FASTest 12CH
S-FHSS
FAST 7CH

FASTest 18CH
FASTest 12CH
FAST MULT

RX CH	2AIL+4FLAP			4AIL+2FLAP			4AIL+4FLAP		
	Airplane	Glider		Airplane	Glider		Airplane	Glider	
		EP			EP			EP	
1	Aileron	Aileron	Aileron	Aileron	Aileron	Aileron	Aileron	Aileron	Aileron
2	Aileron2	Aileron2	Aileron2	Aileron2	Aileron2	Aileron2	Aileron2	Aileron2	Aileron2
3	Throttle	Motor	AUX7	Throttle	Motor	AUX7	Throttle	Motor	AUX7
4	Rudder	Rudder	Rudder	Rudder	Rudder	Rudder	Rudder	Rudder	Rudder
5	Flap	Flap	Flap	Aileron3	Aileron3	Aileron3	Aileron3	Aileron3	Aileron3
6	Flap2	Flap2	Flap2	Aileron4	Aileron4	Aileron4	Aileron4	Aileron4	Aileron4
7	Flap3	Flap3	Flap3	Flap	Flap	Flap	Flap	Flap	Flap
8	Flap4	Flap4	Flap4	Flap2	Flap2	Flap2	Flap2	Flap2	Flap2
9	AUX4	AUX4	AUX4	AUX4	AUX4	AUX4	Flap3	Flap3	Flap3
10	Gear	AUX6	AUX6	Gear	AUX6	AUX6	Flap4	Flap4	Flap4
11	AUX5	AUX5	AUX5	AUX5	AUX5	AUX5	AUX4	AUX4	AUX4
12	AUX3	AUX3	AUX3	AUX3	AUX3	AUX3	Gear	AUX6	AUX6
13	AUX2	AUX2	AUX2	AUX2	AUX2	AUX2	AUX5	AUX5	AUX5
14	AUX1	Butterfly	Butterfly	AUX1	Butterfly	Butterfly	AUX3	Butterfly	Butterfly
15	Camber	Camber	Camber	Camber	Camber	Camber	Camber	Camber	Camber
16	Elevator	Elevator	Elevator	Elevator	Elevator	Elevator	Elevator	Elevator	Elevator
DG1	SW	SW	SW	SW	SW	SW	SW	SW	SW
DG2	SW	SW	SW	SW	SW	SW	SW	SW	SW

The output
CH of each
system

FASTest 18CH
FASTest 12CH
S-FHSS
FAST 7CH

FASTest 18CH
FASTest 12CH
FAST MULT

•Tailless wing Winglet 2Rudder

RX CH	2AIL			2AIL+1FLAP			2AIL+2FLAP		
	Airplane	Glider		Airplane	Glider		Airplane	Glider	
		EP			EP			EP	
1	Aileron	Aileron	Aileron	Aileron	Aileron	Aileron	Aileron	Aileron	Aileron
2	RUD2	RUD2	RUD2	RUD2	RUD2	RUD2	RUD2	RUD2	RUD2
3	Throttle	Motor	AUX7	Throttle	Motor	AUX7	Throttle	Motor	AUX7
4	Rudder	Rudder	Rudder	Rudder	Rudder	Rudder	Rudder	Rudder	Rudder
5	Gear	AUX6	AUX6	Gear	AUX6	AUX6	Aileron2	Aileron2	Aileron2
6	Aileron2	Aileron2	Aileron2	Aileron2	Aileron2	Aileron2	Flap	Flap	Flap
7	AUX5	AUX5	AUX5	Flap	Flap	Flap	Flap2	Flap2	Flap2
8	AUX3	AUX3	AUX3	AUX5	AUX5	AUX5	Gear	AUX6	AUX6
9	AUX2	AUX2	AUX2	AUX3	AUX3	AUX3	AUX5	AUX5	AUX5
10	AUX1	AUX1	AUX1	AUX2	AUX2	AUX2	AUX3	AUX3	AUX3
11	AUX1	AUX1	AUX1	AUX1	AUX1	AUX1	AUX2	AUX2	AUX2
12	AUX1	AUX1	AUX1	AUX1	AUX1	AUX1	AUX1	AUX1	AUX1
13	AUX1	AUX1	AUX1	AUX1	AUX1	AUX1	AUX1	AUX1	AUX1
14	AUX1	AUX1	AUX1	AUX1	Butterfly	Butterfly	AUX1	Butterfly	Butterfly
15	Camber	Camber	Camber	Camber	Camber	Camber	Camber	Camber	Camber
16	Elevator	Elevator	Elevator	Elevator	Elevator	Elevator	Elevator	Elevator	Elevator
DG1	SW	SW	SW	SW	SW	SW	SW	SW	SW
DG2	SW	SW	SW	SW	SW	SW	SW	SW	SW

The output CH of each system

FASTest 18CH
FASTest 12CH
S.FHSS
FAST7CH

FASTest 18CH
FASTest 12CH
FAST MULT

RX CH	2AIL+4FLAP			4AIL+2FLAP			4AIL+4FLAP		
	Airplane	Glider		Airplane	Glider		Airplane	Glider	
		EP			EP			EP	
1	Aileron	Aileron	Aileron	Aileron	Aileron	Aileron	Aileron	Aileron	Aileron
2	Aileron2	Aileron2	Aileron2	Aileron2	Aileron2	Aileron2	Aileron2	Aileron2	Aileron2
3	Throttle	Motor	AUX7	Throttle	Motor	AUX7	Throttle	Motor	AUX7
4	Rudder	Rudder	Rudder	Rudder	Rudder	Rudder	Rudder	Rudder	Rudder
5	Flap	Flap	Flap	Aileron3	Aileron3	Aileron3	Aileron3	Aileron3	Aileron3
6	Flap2	Flap2	Flap2	Aileron4	Aileron4	Aileron4	Aileron4	Aileron4	Aileron4
7	Flap3	Flap3	Flap3	Flap	Flap	Flap	Flap	Flap	Flap
8	Flap4	Flap4	Flap4	Flap2	Flap2	Flap2	Flap2	Flap2	Flap2
9	RUD2	RUD2	RUD2	RUD2	RUD2	RUD2	Flap3	Flap3	Flap3
10	Gear	AUX6	AUX6	Gear	AUX6	AUX6	Flap4	Flap4	Flap4
11	AUX5	AUX5	AUX5	AUX5	AUX5	AUX5	RUD2	RUD2	RUD2
12	AUX3	AUX3	AUX3	AUX3	AUX3	AUX3	Gear	AUX6	AUX6
13	AUX2	AUX2	AUX2	AUX2	AUX2	AUX2	AUX5	AUX5	AUX5
14	AUX1	Butterfly	Butterfly	AUX1	Butterfly	Butterfly	AUX3	Butterfly	Butterfly
15	Camber	Camber	Camber	Camber	Camber	Camber	Camber	Camber	Camber
16	Elevator	Elevator	Elevator	Elevator	Elevator	Elevator	Elevator	Elevator	Elevator
DG1	SW	SW	SW	SW	SW	SW	SW	SW	SW
DG2	SW	SW	SW	SW	SW	SW	SW	SW	SW

The output CH of each system

FASTest 18CH
FASTest 12CH
S.FHSS
FAST7CH

FASTest 18CH
FASTest 12CH
FAST MULT

* Output channels differ by each system of a table. When using a system with few channels, there is a wing type which cannot be used. It cannot be used when there is a function required out of the range of the arrow of a figure.

Helicopter

●FASSTest 18CH / FASST MULTI / FASST 7CH / S-FHSS

CH	H-4/H-4X Swash	All Other
1	Aileron	Aileron
2	Elevator	Elevator
3	Throttle	Throttle
4	Rudder	Rudder
5	Gyro	Gyro
6	Pitch	Pitch
7	Governor	Governor
8	Elevator2	Governor2
9	GYRO2	GYRO2
10	GYRO3	GYRO3
11	Governor2	Needle
12	Needle	AUX5
13		AUX4
14		AUX3
15		AUX2
16		AUX1
DG1		SW
DG2		

The output CH of each system
 FASSTest 18CH
 S-FHSS
 FASST 7CH
 FASST MULTI

●FASSTest 12CH

CH	H-4/H-4X Swash	All Other
1	Aileron	Aileron
2	Elevator	Elevator
3	Throttle	Throttle
4	Elevator2	Rudder
5	Pitch	Pitch
6	Gyro	Gyro
7	Governor	Governor
8	Rudder	Governor2
9	GYRO2	GYRO2
10	GYRO3	GYRO3
DG1		SW
DG2		

The output CH of each system
 FASSTest 12CH

FUNCTIONS OF LINKAGE MENU

The Linkage Menu has all of the functions you will need to perform model addition, model type selection, frequency setting, end point setting, and other model basic settings.

The functions which can be selected depend on which model type you are using. A typical menu screen is shown below.

- When you touch the Linkage Menu button on the Home screen, the menu shown below is called up. Touch the button of the function you want to set.

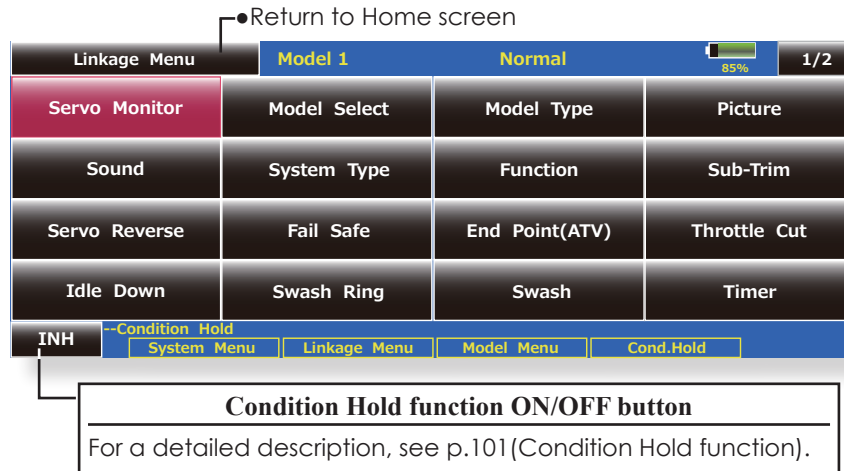

Linkage Menu functions table

- [Servo Monitor]: Displays the servo test and operation position
- [Model Select]: Model addition, call, deletion, copy, model name setting
- [Model Type]: Model type, wing type, switch type, etc. selection
- [Picture]: Picture selection and setting for each model
- [Sound]: Sound recording and playback
- [System Type]: System selection, receiver link, telemetry.
- [Function]: Channel assignment of each function can be changed
- [Sub-Trim]: Adjusts the neutral position of each servo
- [Servo Reverse]: Servo direction reversal
- [Fail Safe]: Fail safe function and battery fail safe function setting
- [End Point (ATV)]: Servo basic rudder adjustment and limit setting
- [Throttle Cut]: Stops the engine safely and easily (airplane and helicopter only)
- [Idle Down]: Lowers the idle speed of the engine (airplane and helicopter only)
- [Swash Ring]: Limits the swash travel within a fixed range to prevent linkage damage (helicopter only)
- [Swash]: Swash AFR and linkage correction function (helicopter only)
- [Timer]: Timer setting and lap time display
- [Dial Monitor]: Dial, slider, and digital trim position display and setting.
- [Function Name]: Function Name can be changed
- [Telemetry]: Displays various data sent from the receiver.
- [Sensor]: Various telemetry sensors setting
- [Warning]: Warning sound and vibration setting.
- [Data Reset]: Model memory data reset (by various item)

Servo Monitor

Servo Test & Graph Display / Displays servo positions.

This is used for testing servo movement. Touch “Moving Test” (repetition mode) or “Neutral Test” (fixed position mode) depending on which one shows on the screen. To get from one to the other, simply touch the field again, and you will

move from “Moving Test” to “Neutral Test” automatically. Next touch the “Test” on/off button to start testing your servos. The “Neutral test” is good for finding the neutral position of a servo horn.

- Touch the [Servo Monitor] button in the Linkage Menu to call the setup screen shown below.

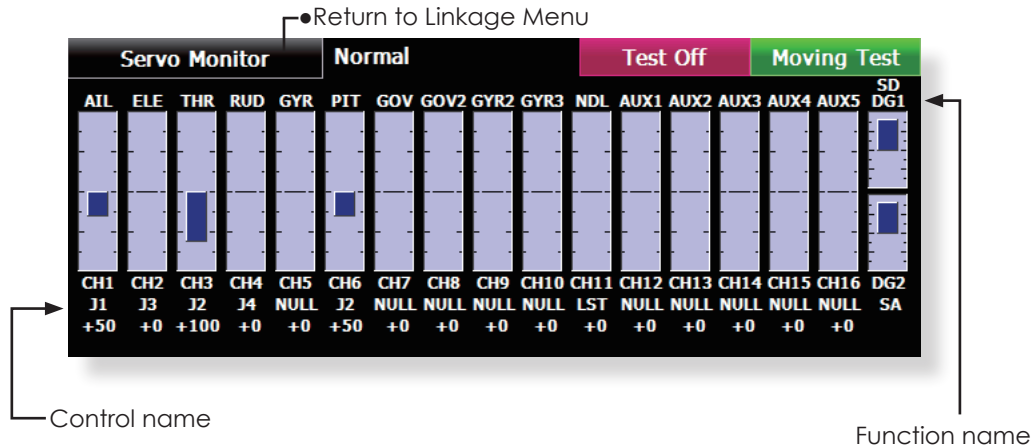

Servo test operation

1. Select a test mode ([Moving] or [Neutral]).
[Repeat]: Each servo repeats operation.
[Neutral]: Each servo is locked in the neutral position.
2. When the [Test Off] button is touched, testing begins in the selected mode.

⚠ WARNING

- ⊘ Don't set a servo test mode when the drive motor is connected and the engine was started.
 - Inadvertent rotation of the motor or acceleration of the engine is extremely dangerous.

Model Select

The Model Selection function performs model addition, selection, deletion, copy, and model name setting.

This function is used to load the settings of the desired model into the T18MZ's memory.

The settings may be selected from either the transmitter's built-in memory or a SD card/USB memory.

The name of the model stored in the transmitter and the SD card/USB memory may be changed. This can be very useful to tell different models settings apart. Each model name can be as long as 32 characters, and

the model name always appears in the display screen.

The Copy function is used to copy one set of model data into a second memory within the transmitter and the SD card/USB memory. It may be used for getting a head-start on setting up models with almost the same settings (only differences need to be modified, instead of entering the complete model from scratch). Also, this function may be used to make a backup copy of a model setup before any changes are made.

- Touch the [Model Select] button in the Linkage Menu to call the setup screen shown below.
- Check mark

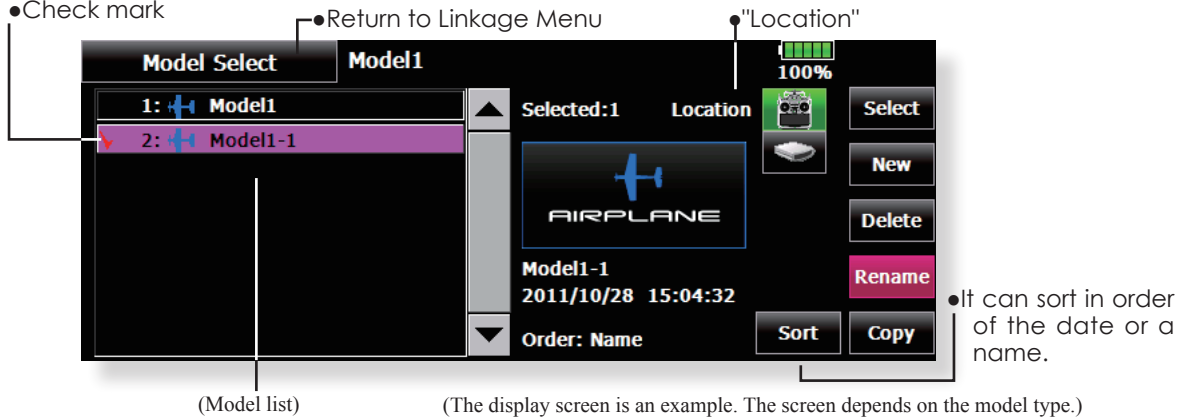

(Model list)

(The display screen is an example. The screen depends on the model type.)

Model call

1. Touch the "Location" icon, and select the location to which the desired model is to be saved.
Transmitter icon: Transmitter memory
SD card icon: SD card
USB memory icon: USB memory
2. Touch the desired model in the model list.
3. Touch the [Select] button.
4. Touch [Yes] to call the model. (When you want to cancel model call, press [No].)

Model addition

1. Touch the [New] button.
2. Touch [Yes] to add the model. (When you want to cancel model addition, touch [No].)
*When a new model is added, the Model Type screen is automatically displayed. Check or change the model. If there are no changes, touch the Model Type icons.
*The added model is displayed in the model list.

Model deletion

1. Touch the "Location" icon or the model you want to delete in the model list. (The model currently selected cannot be deleted.)
2. Touch the [Delete] button.
3. Touch [Yes]. (When you want to stop model deletion, touch [No].)

Model name change

1. Select the model by touching the "Location" icon or the desired model in the model list.
2. When [Rename] is touched, a keyboard appears on the screen.
3. Enter the model name from this keyboard.
*Up to 32 characters can be input at the model name.

Model copy

1. Select a model to copy from the list.
2. Check mark is attached to the model and a "Copy" button is displayed on the right.
3. Touch the "Copy" button and Touch the "Destination" button and select the copy storage destination. (Transmitter or SD card/USB memory)
4. Touch the center [Copy] button.
5. When [Yes] is touched, copying is executed. (When you want to cancel copying, touch [No].)
* If there is no model with the same name in the copy destination, the name of the copied model is saved. If there is a model of the same name, a number is added at the end of the model name and the model is copied. You can change the name later.
*When the model data is copied, the model date is reset to the date that the copy was done.

Model Type

This function allows you to select the model type from among airplane, helicopter, and glider.

Seven types of main wings and three types of tail wings are available for airplanes. Eight swash types are available for helicopters. Seven types of main wings and three types of tail wings are available for gliders. Functions and mixing necessary for each model type are set in advance at the factory.

Note: The Model Type function automatically selects the optimal output channels, control functions, and mixing functions for the chosen model type. When the Model Type Selection is accessed, all of settings in the active model are cleared. Be sure that you don't mind losing this data, or back it up to memory using the copying functions.

- Touch the [Model Type] button in the Linkage Menu to call the setup screen shown below.

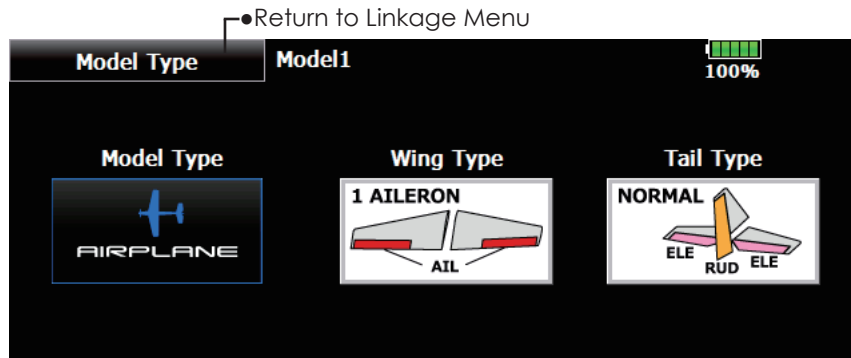

(The display screen is an example. The screen depends on the model type.)

Model type selection

1. Set the Model type, Wing type, Tail type, or Swash type by using the appropriate button.
2. Set the type you choose by touching [Yes] at the confirmation screen. (When you want to cancel model type selection, touch [No].)

Date changes after a swash type change

Data that has been set may change if the swash type of your helicopter is changed. (Refer to the following table) When data is changed the [swash setting] screen is initialized.

Before	After	Data taking over
H-1, H-2, HE3, HR3, HN3, H-3	H-1, H-2, HE3, HR3, HN3, H-3	OK
H-4, H-4X	H-4, H-4X	OK
H-1, H-2, HE3, HR3, HN3, H-3	H-4, H-4X	NG
H-4, H-4X	H-1, H-2, HE3, HR3, HN3, H-3	NG

- When a data change will occur, the confirmation screen of data initialization menu will be displayed. A push on [yes] will initialize data and allow changes. A push on [no] will stop data changes.

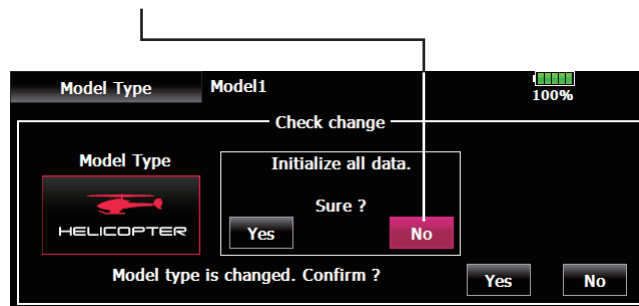

● Model type selection

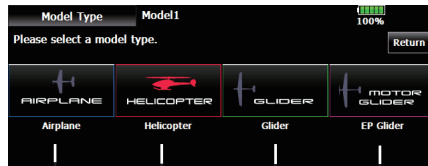

Model type
Select the model type from among airplane, helicopter, glider, and motor glider.

(Airplane, glider)

(Helicopter)

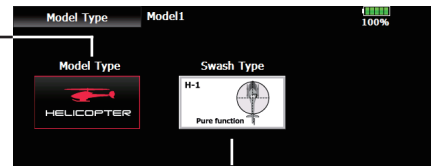
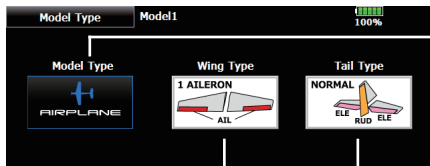

● Wing type selection (1/2)

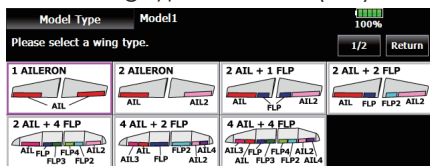

● Swash type selection

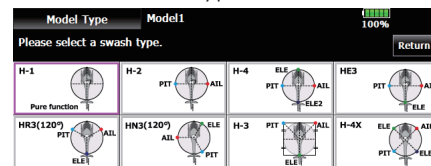

Helicopter swash type
Select from among H-1, H-2, H-4, HE3, HR3, HN3, H-3, and H-4X.

● Wing type selection (2/2)

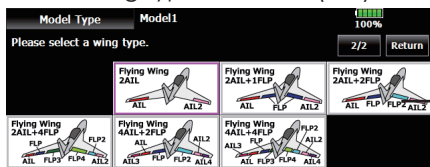

● Rudder type selection

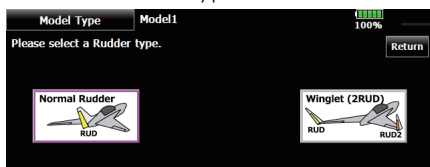

Wing type (1/2) (Normal)
Select from among :
1 aileron, 2 ailerons, 2 ailerons + 1 flap,
2 ailerons + 2 flaps, 2 ailerons + 4flaps,
4 ailerons + 2 flaps, 4 ailerons + 4 flaps.

Wing type (2/2) (Tailless wing)
Selection from among:
2 ailerons, 2 ailerons + 1 flap,
2 ailerons + 2 flaps, 2 ailerons + 4 flaps,
4 ailerons + 2 flaps, 4 ailerons + 4 flaps.
*For tailless wing, the rudder type can be selected from normal rudder and winglet.

● Tail type selection

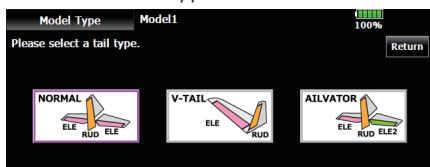

Tail type
Select from normal, V tail, and elevator.

Picture

A picture on the home screen can be set for each model. (Simplifies identification of the model data during screen operation.)

A photograph of the model taken with a T18MZ camera, digital camera or other file can be pasted as the screen display data for each model. This is convenient in identifying models with the same model name.

*The picture files which can be displayed on the screen are size 168 x 80 pixels, file type .bmp (bit map picture) and JPEG files. If a file larger than 168x80 is used, the picture displayed will be reduced.

When a picture is pasted, it is displayed as a screen image in the following screens:

- Model Select screen
- Home screen
- Startup screen

- Touch the [Picture] button in the Linkage Menu to call the setup screen shown below.

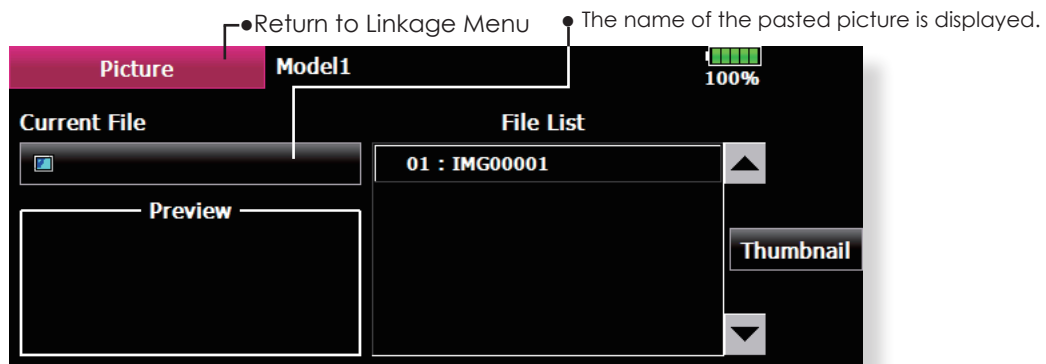

Pasting a picture

- *Picture data is set to the model memory currently in use.
 - *You can choose to use a picture that is saved in these places: T18MZ, SD card, USB memory.
1. Select the picture from the File List by touching the desired picture data.
*Before selection, touch the scroll button at the top or bottom of the Thumbnail and confirm the contents of the picture to be saved by the preview screen.
 2. To paste the picture, touch [Yes]. (When you want to cancel pasting, touch [No].)

[Important]

Before reading data from the PC, insert the SD card/USB memory into the transmitter and turn on the power. The following folders are automatically written. To read a file from the PC, copy the file to a folder by file type.

- BMP: Picture file
- WAV: Audio file
- WMA: Music file
- MODEL: Model data

Copy/Delete/Release/Rename of picture

1. Select the picture from the [Thumbnail] by touching the desired picture data.
2. To paste the picture, touch this screen is displayed.
3. Copy (T18MZ/SD card/USB memory), Delete, Release, Rename or selection.
*Release : It loses from Current File.
Delete : Picture data is deleted.
*If the data which is not pasted is chosen from a thumbnail, the [Entry] button will appear, and if it is pushed, it can be pasted and do.
4. Next, it chooses in [Yes] and [No]. In Rename, name is inputted into the keyboard which appeared, and, finally it pushes Enter.

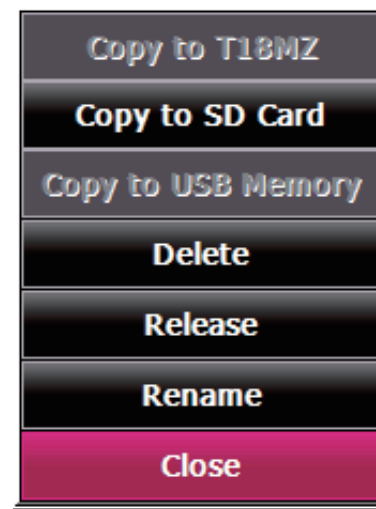

Sound

Sound recording and playback.

Sounds recorded with the microphone built into the transmitter or any audio files (.wav) can be set to the power switch or any preset switch that you choose.

*Only a .wav file saved in the same storage place (T18MZ, SD card, a USB memory) as the current model can be chosen.

*The maximum recording time from the microphone is 3 seconds. Twenty-four audio files can be saved.

*The only audio file type which can be recorded is .wav. Only the sounds recorded with the built-in microphone or an audio file saved from your PC to an SD card can be played back.

Setup screens No. 3 to 24 can be individually

assigned to audio file switches, etc. The playback files can be switched each time the same switch is operated. This can be used when playing back the name of maneuvers, etc.

[Sound starting]

No. 1: When transmitter power switch turned on

No. 2: When transmitter power switch turned off

No. 3~24: Switch can be set.

[Important]

Before reading data from a PC, insert the SD card/USB memory into the transmitter and turn on the power. The following folders are automatically written. When reading a file from the PC, copy it to a holder by file type.

- BMP: Picture file
- WAV: Audio file
- WMA: Music file
- MODEL: Model data

- Touch the [Sound] button in the Linkage Menu to call the setup screen shown below.

●Return to Linkage Menu

Sound			Model1			100% File		1/2 Rec	
No	Switch	Mode	File	Rec No	Switch	Mode	File	Rec	
1	Start up			7	OFF	→			
2	Power off			8	OFF	→			
3	OFF	→		9	OFF	→			
4	OFF	→		10	OFF	→			
5	OFF	→		11	OFF	→			
6	OFF	→		12	OFF	→			

<Sound>			Model1			Copy to T18MZ		Copy to SD Card		Copy to USB Memory	
No	Switch	Mode	File	Rec	01 : test.wav	02 : Sound	Delete	Entry	Rename	Close	
1	Start up										
2	Power off										
3	OFF	→									
4	OFF	→									
5	OFF	→									
6	OFF	→									

(Saved sound file)

- Touch the file button Copy/Delete/Entry/Rename is made.

It is the same procedure as the picture of the preceding clause.

Voice Recording

1. Touch any REC button to call up the SOUND RECORDER screen.
2. Touch the REC button to start recording. (Recording time: 3 seconds)
3. Record your voice as you are facing the transmitter's microphone.

*Speak loudly and clearly.

4. To finish, press "CLOSE". Also sound files

created by your PC may be played back by assigned switches. (File types; .wav file only)



*A voice file is saved automatically to the location of the model you are currently using. Whether in the transmitter, SD card, or USB memory. A file name is displayed on the file button corresponding to a recording button.









Assignment of audio files to switches

- *Audio files can be saved beforehand.
1. Touch the file button of the No. you want to set. A list of the files stored is displayed.
 2. Select the audio file you want to play back from the list of audio files.
- *Since the audio files are played back when the audio file names in the list are touched, the file contents can be checked before assignment.
3. Touch the [File] button to assign the files.
 4. (Switches are also selected for No. 3~24.)
Touch the [NULL] button to call the Switch select screen.
 5. Select the switch and its ON direction at the

Switch select screen.
(For a detailed description of the selection method, see "Switch setting method" at the back of this manual.)

Mode button

-  Playing back registered file only once
-  Playing back registered file repeatedly
-  Sequentially playing back registered file each time operated by 1 switch

Sound			Model1			85%			1/2
No	Switch	Mode	File	Rec	No	Switch	Mode	File	Rec
1	Start up				7				
2	Power off				8				
3	SG				9				
4					10				
5					11				
6					12				

Sequentially playing back registered file each time operated by 1 switch

This is used when calling the order of maneuvers, etc.

[Setting method]

1. After selecting the switch, press the [→] button. The button display thereafter is switched as shown in the screen above.
2. Assign the audio files in the order in which you want to play them back.

The audio files are played back each time the switch selected by the above setting is turned on.

System Type System mode setting, Receiver link

System Type selection

The T18MZ is for 2.4GHz only. The system can be changed from among 5 choices: FASSTest 18CH, FASSTest 12CH, FASST MULTI, FASST 7CH, S-FHSS. Select the system matched to the type of receiver you are using.

*Even if it changes a System Type, other model data is not reset.

*If a system type is changed in the case of a helicopter, It can choose out of two channel orders.

[Yes] : Selection sets the channel order suitable for System Type. (We recommend here.)

[No] : The present channel order is maintained.

*After change should operate a model and should fully check a direction and a motion.

Receiver linking

The receiver will only be controlled (without being affected by other transmitters) by the transmitter it is linked to. When using a receiver other than one purchased as a set, linking is necessary.

Dual receiver function (only FASSTest 18CH mode)

Dual receivers can be linked with the T18MZ. Two receivers are recognized individually by ID numbers. For example, in R7008SB, CH output setting function is used, by setting the first as "1-8CH", and setting the second as "9-16CH", two sets of receivers can be used as a set in the model, allowing you 16 channels. If a Dual receiver function is used, the following function can set up individually.

- Battery fail-safe voltage setup
- Telemetry function ON/OFF
- Sensor setup

- Touch the [System Type] button in the Linkage Menu to call the setup screen shown below.

Return to Linkage Menu

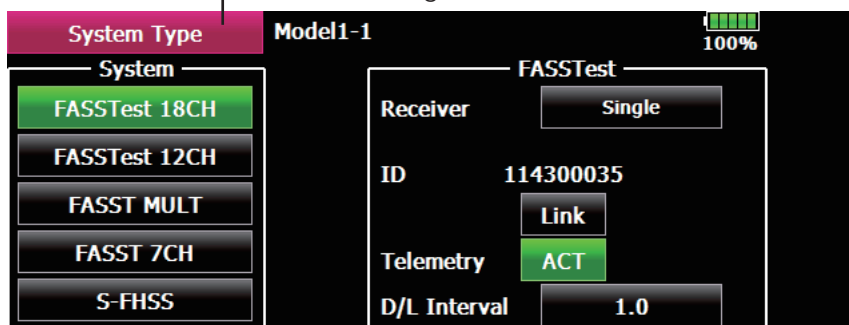

Telemetry function (FASSTest mode only)

To use the telemetry function, set "Telemetry" to "ON".

D/L Interval (FASSTest mode only)

When a telemetry function is enabled, the receiving interval (down-link interval) of sensor data can be changed.

If a D/L interval is increased, the response of the sensor data display becomes slower, but stick response will improve.

Battery fail-safe voltage setup (only FASSTest mode)

The voltage which battery fail-safe activates, can be set when you link. (3.5-8.4V) The receiver memorizes the setting as it was at link.

Suggested setting voltages are as follows.

- 4 cells NiCd or NiMH (Normal: 4.8v) = 3.8 v
- 2 cells LiFe (Normal: 6.6 v) = 6.0 ~ 6.2 v
- 2 cells LiPo (Normal: 7.4 v) = 7.2 ~ 7.4 v

It is a rough reference value.

Since it changes with servos carried in the condition and the model of a battery, please set to your own model in a battery consumption current.

Linking method (T18MZ ↔ R7008SB)

1. Bring the receiver to be linked to within 50cm of the transmitter.
2. Press the [Link] button in the [Link] box of [System Type].
3. The transmitter emits a chime sound and enters the link mode.
4. The receiver power is immediately turned on. About 2 seconds after the power is turned on the receiver enters the linking state.
(Receiver linking time is about 1 second)
5. If linking is successful, the receiver LED changes from red to green, the link mode ends, and the receiver ID code is displayed.
6. If linking fails, an error message is displayed. Bring the transmitter closer to the receiver and repeat the procedure above from Step 2.

*Do not perform the linking operation when the drive motor is connected or the engine is running.

* When you use two receivers, please be sure to setup a "primary" and "secondary" in the "dual" mode.

*Since two sets of receivers cannot be individually recognized without using a "primary" and "secondary" setup, it is impossible to receive telemetry data correctly.

* You must link one receiver at a time. If both power supplies to the receivers are switched on simultaneously, data is received incorrectly by the transmitter.

* If a dual receiver function is used, in order to receive sensor information correctly by both sets, telemetry data will be slower compared to a single receiver setup.

* You cannot link three sets of receivers.

- Touch the [Link] button in the System Type Menu to call the setup screen shown below.



- Battery fail-safe voltage setup (only FASSTest mode)

- Return to System Type Menu

⚠ WARNING

- ⊘ Do not perform the linking operation when the drive motor is connected and the engine was started.

■ Inadvertent rotation of the motor or acceleration of the engine is extremely dangerous.

- ⓘ Once the link operation is complete, please check that your receiver can be operated with the linked transmitter.

- ⓘ Check operation sufficiently before flying after linking.

■ If the same receiver is sending in the vicinity, there is the danger that the transmitter may be linked with that receiver.

⚠ CAUTIONS

- ⓘ Always turn on the transmitter power after linking is complete.

- ⓘ When pairing with the transmitter, be sure that a previously linked transmitter is not transmitting

The example for choosing System Type

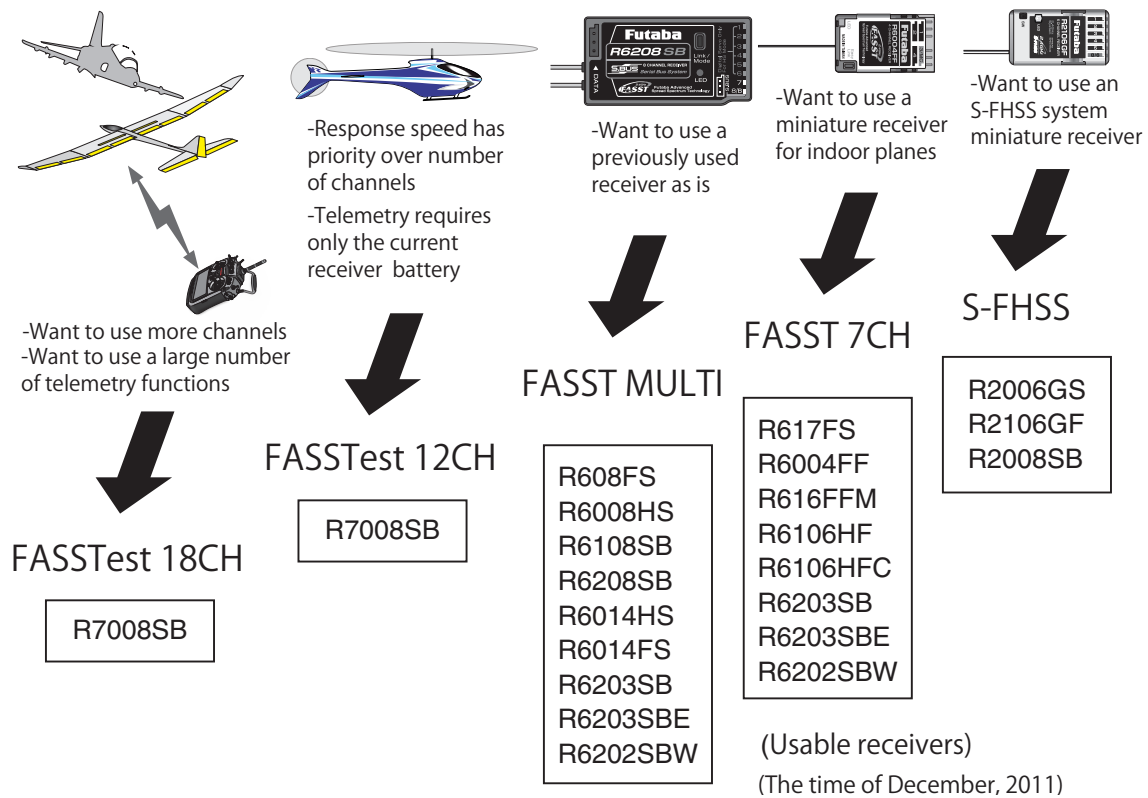

System Type

- **FASSTest 18CH** --- FASSTest system receiver mode. Applicable with the telemetry sensor unit. Up to 18 channels (linear 16+ON/OFF2) can be used.
- **FASSTest 12CH** --- FASSTest system receiver mode. Applicable with receiver voltage display. Up to 12 channels (linear 10+ON/OFF2) can be used. Telemetry Sensor cannot be used, but the response speed is a faster than that of the 18CH mode.
- **FASST MULTI** --- FASST-MULTI system receiver mode. Up to 18 channels (linear 16+ON/OFF2) can be used.
- **FASST 7CH** --- FASST-7CH system receiver mode. Up to 7 channels can be used.
- **S-FHSS** --- S-FHSS system receiver mode. Up to 8 channels can be used.

Function

Channel assignment for each function can be changed to suit your needs.

When you select model and wing (swash) types, you will find that the optimized combinations of servo output channels and functions have been already preset. If you would like, on the function-setting screen of the linkage menu, you can freely change combinations of servo output channels, functions (aileron, elevator, etc), and input controllers (sticks, switches, trim levers and trim switches). You can also assign the same function to multiple servo output channels such as assigning elevator function to CH2 and CH3.

- Touch the [Function] button in the Linkage Menu to call the setup screen shown below.

DG1, DG2 (switch channels)

These two channels can be used as switch (On/Off) channels. You can freely change combinations between servo output channels and input controllers (sticks, switches, trim levers and trim switches).

Channel restrictions by a System Type

FASSTest 18CH---16 CH+2 Switch
 FASSTest 12CH---10 CH+2 Switch
 FASST MULTI ---16 CH+2 Switch
 FASST 7CH --- 7 CH
 S-FHSS --- 8 CH

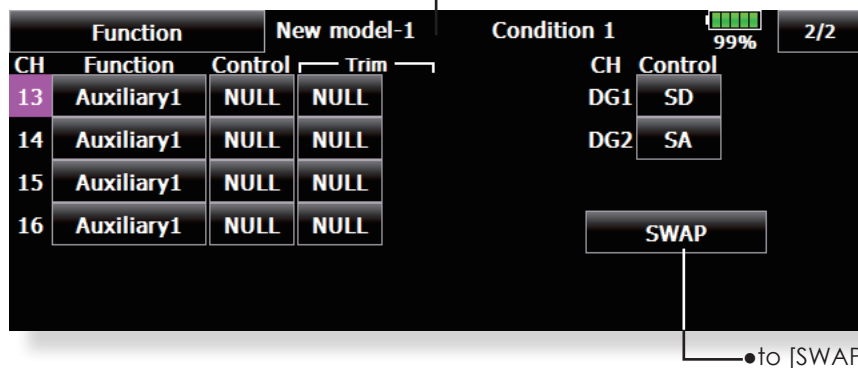
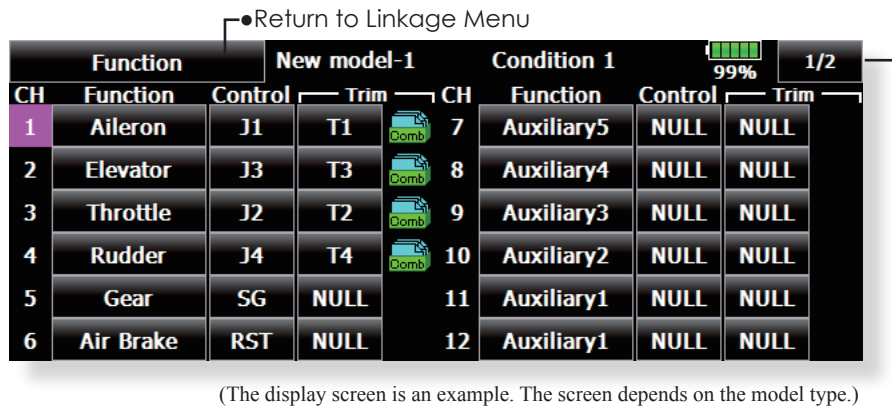

Function change

1. Touch the function button of the channel you want to change to call the function list.
2. Select the function you want to change.
3. Touch [Yes]. The display returns to the original screen. (When you want to cancel function change, touch [No].)

*Multiple channels can be assigned to 1 function.

*Multiprop1,2 is an optional object for Multiprop decoders.

<CH which can be Multiprop set up.>

FASSTest 18CH---1-12CH
 FASSTest 12CH---not set
 FASST MULTI ---11,12CH
 FASST 7CH ---not set
 S-FHSS ---not set

Operation control change

1. Touch the control button of the channel you want to change. A Control select screen (stick, switch, knob, trim lever, etc.) is displayed.
2. Select the control you want to operate.
3. Touch [Close]. The display returns to the preceding screen.

*The same control can be assigned to multiple channels.

SWAP

If [SWAP] is pushed, it will call up the following screen. You can easily change two separate functions, keeping the data that was set for each channel.

1. Touch the Trim button two channels to change is pushed.
2. If [OK] is pushed, two channels will interchange.

*It can choose only two.

Ch	Function	Ch	Function	Ch	Function
1	Aileron	7	Aileron4	13	Auxiliary1
2	Elevator	8	Flap	14	Auxiliary2
3	Throttle	9	Flap2	15	Auxiliary3
4	Rudder	10	Flap3	16	Camber
5	Aileron2	11	Flap4		
6	Aileron3	12	Gear		
				OK	CANCEL

Trim change

1. Touch the Trim button to call the Trim setup screen.
2. The following items can be set at the Trim setup screen.

- Hardware setting (Selection of switch, etc. which controls trim) (The select screen is called by touching the [H/W Select] button.)
- Rate setting
- Operation step setting
- Trim mode setting

Normal mode: Normal trim (linear) operation

ATL mode: ATL operation mode. (Works at only one end of operation) Reverse is also possible.

CTRM mode: Maximum change near center by center trim operation (Does not change at end of the stick movement)

- Separate/combination mode: Trim data can be set to different flight conditions
Separate mode: Trim adjustment for each separate flight condition.

<Function> Model1-1 Condition 1 99%

<Control> CH1 Aileron

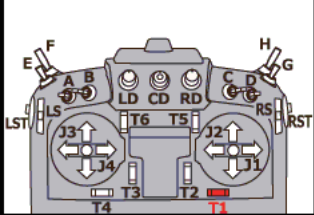

J1	T1	SA	SE	LST	NULL
J2	T2	SB	SF	LS	
J3	T3	SC	SG	LD	Gr.
J4	T4	SD	SH	RD	
CD	T5			RS	Trim
CD-SW	T6			RST	Close

(The display screen is an example. The screen depends on the model type.)

Sub-Trim

Setting of neutral position of each servo.

The Sub-Trim function is used to set the servo neutral position, and may be used to make fine adjustments to the control surface after linkages and pushrods are hooked up. When you begin to set up a model, be sure that the digital trims are set to their center position.

- Touch the [Sub Trim] button in the Linkage Menu to call the setup screen shown below.

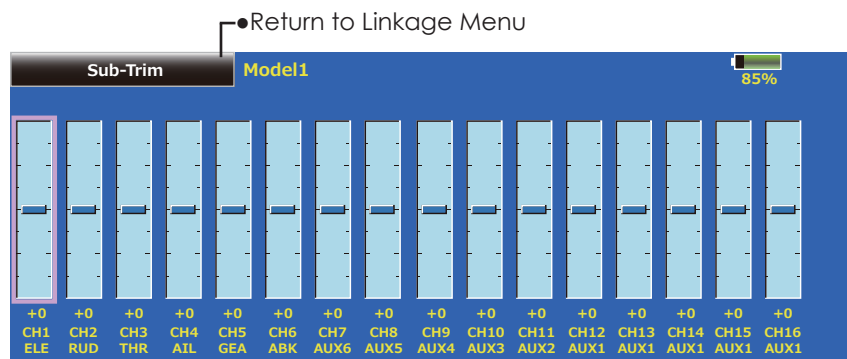

(The display screen is an example. The screen depends on the model type.)

Sub trim adjustment

1. Touch the trim display part of the channel you want to adjust.
Adjustment buttons appears on the Sub Trim menu screen.
2. Use the adjustment buttons to adjust the sub trim.
 - Initial value: 0
 - Adjustment range: -240~+240 (steps)

*See above
3. Repeat this step for each channel.

Servo Reverse

Use to reverse the servo throw direction.

Servo Reverse changes the direction of an individual servo's response to a control stick movement.

For CCPM helicopters, be sure to read the section on Swash AFR before reversing any servos. With CCPM helicopters, always complete your servo reversing prior to any other programming. If you use pre-built Airplane/Sailplane functions that control multiple servos, it may be confusing to tell whether the servo needs to be reversed or a setting in the function needs to be reversed. See the instructions for each specialized function for further details. Always check servo direction prior to every

flight as an additional precaution to confirm proper model memory, hook ups, and radio function.

⚠ WARNING

! Before a flight, it always check that your models servo operation, the direction of control surfaces, and switch setup are correct.

! Default setting of the motor channel is always reverse.

- Touch the [Servo Reverse] button in the Linkage Menu to call the setup screen shown below.

Return to Linkage Menu

Servo Reverse			Model1			70%		
CH	Function	Setting	CH	Function	Setting	CH	Function	Setting
1	Aileron	NORM	7	Auxiliary5	NORM	13	Auxiliary1	NORM
2	Elevator	NORM	8	Auxiliary4	NORM	14	Auxiliary1	NORM
3	Throttle	NORM	9	Auxiliary3	NORM	15	Auxiliary1	NORM
4	Rudder	NORM	10	Auxiliary2	NORM	16	Auxiliary1	NORM
5	Gear	NORM	11	Auxiliary1	NORM		DG1	NORM
6	Air Brake	NORM	12	Auxiliary1	NORM		DG2	NORM

(The display screen is an example. The screen depends on the model type.)

Servo reversing procedure

After setting up a new model, be sure to define all special menus. Be sure that all servos are plugged into the proper receiver channels. Now, determine whether you need to reverse any channels by moving each stick and observing the corresponding movement in the model's controls.

1. Touch the desired channel's Setting button to choose the proper direction for the servo
2. Touch "Yes" in the next screen.
3. Repeat for each servo needing reversal.

When done, touch "Servo Reverse" to return to the Linkage Menu.

Fail Safe

Sets the servos operating position when transmitter signals can no longer be received or when the receiver battery voltage drops.

The Failsafe function is used to set up positions that the servos will move to in the case of radio interference. Defines servo position when signals are lost and when receiver battery voltage becomes low.

You may set either of two positions for each channel: Hold, where the servo maintains its last commanded position, or fail safe, where each servo moves to a predetermined position. You may choose either mode for each channel.

The T18MZ system also provides you with an advanced battery monitoring function that warns you when the receiver battery has only a little power remaining. In this case, each servo is moved to the defined failsafe position. The battery failsafe may be released by operating a predefined control on the transmitter (default is throttle). **Do not continue to fly, land as soon as possible.** Remember, if the predefined control suddenly

moves to a position you did not command, land at once and check your receiver battery.

Do not continue to fly, land as soon as possible. Defines servo position when signals are lost and when receiver battery voltage becomes low.

⚠ WARNING

For safety, always set the fail safe functions.

- Especially set the throttle channel fail safe function so that the servo moves to the maximum slow side for airplanes and to the slow side from the hovering position for helicopters. Crashing of the model at full high when normal radio waves cannot be received due to interference, etc., is very dangerous.
- If fail safe is reset by throttle stick movement, the fail safe may be mistaken as an engine malfunction and will be reset at low throttle and the model will continue to fly. If you have any doubts, immediately land.

- Touch the [Fail Safe] button in the Linkage Menu to call the setup screen shown below.

Return to Linkage Menu

Fail Safe			New model-1			Batt. F/S Release	OFF	1/2
CH	Function	Mode	B.F/S	F/S Posi.	CH	Function	B.F/S	F/S Posi.
1	Aileron	Hold	OFF		7	Auxiliary5	Hold	OFF
2	Elevator	Hold	OFF		8	Auxiliary4	Hold	OFF
3	Throttle	Hold	OFF		9	Auxiliary3	Hold	OFF
4	Rudder	Hold	OFF		10	Auxiliary2	Hold	OFF
5	Gear	Hold	OFF		11	Auxiliary1	Hold	OFF
6	Air Brake	Hold	OFF		12	Auxiliary1	Hold	OFF

To <Switch> screen

(The display screen is an example. The screen depends on the model type.)

Fail safe setting procedure

Decide which channels you want to go to preset positions, and which ones you want to maintain their last commanded position. To select the fail safe mode you wish to set, use the F/S button. This button toggles between the two modes. (Hold, F/S)

F/S mode setting:

1. Touch the F/S button of the channel you want to set, and set that channel to the [F/S] mode.
2. Hold the corresponding stick, control, slider, or other control in the position you want the servo to move to when the fail safe function is activated, and touch the F/S position button. That position is displayed in percentage.

*When you want to return that channel to the Hold mode, touch the [F/S] button again.

Battery fail safe setting procedure

To select the B.F/S mode, touch the [B.F/S] button. Each time the button is touched, it toggles

between [OFF] and [B.F/S].

B.F/S setting:

1. Touch the [B.F/S] button of the desired channel to set it to the B.F/S mode.
2. Hold the corresponding stick, VR, slider, or other control in the position you want the servo to move to when the battery fail safe function is activated, and touch the F/S position button. This position is displayed in percentage.

*When you want to return that channel to OFF, touch the [B.F/S] button again.

Battery Fail safe Release Function

This function releases the predefined control from its held position after indicating that your receiver battery is low.

1. Enter the control setting screen by touching the Battery F/S Release button. Now, you may choose whether moving the throttle resets the condition, or select a stick or switch to deactivate it. To set a desired throttle release position, move the throttle stick to the point at which you wish the B.F/S to be released.

End Point (ATV)

Sets the travel, limit point, and speed of each servo.

The End Point function adjusts the left and right servo throws, generates differential throws, and will correct improper linkage settings.

The Travel rate(normal full stick movement at high rates) can be varied from 30% to 140% in each direction on channels 1 to 16. Also, the Limit point (how far the servo travels when a mix is involved) where servo throw stops may be varied from 0% to 155%.

Note: The indicators on the screen display actual servo throw of the each channel. The center position of the indicator is based on the Sub-Trim settings. Therefore the Sub-Trim adjustment changes the Limit point display of the indicator. The Servo Speed setting is used to set the servo delay for each channel, from channel 1 to channel 16. The system uses the programmed speed (delay) to slow down servo position changes. The Servo Speed setting can be varied from 0 to 27 in each channel.

- Touch the [End Point (ATV)] button in the Linkage Menu to call the setup screen shown below.

Return to Linkage Menu

End Point(ATV)		New model-1					99%	1/3
CH	Function	Limit	Travel	← ↑ ↻	↻ ↓ →	Travel	Limit	Speed
1	Aileron	135%	100%			100%	135%	0
2	Elevator	135%	100%			100%	135%	0
3	Throttle	135%	100%			100%	135%	0
4	Rudder	135%	100%			100%	135%	0
5	Gear	135%	100%			100%	135%	0
6	Air Brake	135%	100%			100%	135%	0

(The display screen is an example. The screen depends on the model type.)

Servo travel adjustment

1. Touch the Travel button of the channel you want to set. Adjustment buttons appear on the screen.
2. Use these buttons to adjust the rate.
 - Initial value: 100%
 - Adjustment range: 30%~140%
3. Repeat the procedure above for each rate.

Limit point adjustment

1. Touch the Limit button of the channel you want to set.
2. Use the adjustment buttons to adjust the limit point.
 - Initial value: 135%
 - Adjustment range: 0%~155%
3. Repeat this procedure for each limit point.

Servo speed setting

1. Touch the Speed button of the channel you want to set.
2. Use the adjustment buttons to adjust the servo speed.
 - Initial value: 0
 - Adjustment range: 0~27 (steps)
3. Repeat this procedure for each channel.

To close this screen, touch the [End Point (ATV)] button.

Throttle Cut Stops the engine safely and easily.(airplane and helicopter only)

Throttle cut provides an easy way to stop the engine, by flipping a switch with the throttle stick at idle. The action is not functional at high throttle to avoid accidental dead sticks. The switch's location and direction must be chosen, as it defaults to NULL.

Note: When conditions are set, at Throttle cut setup can be performed for each condition. Throttle cut can only be activated in a specific condition if you have selected and set up this function within the condition. When using throttle cut in a specific condition, and ON or active. If you change to another condition, throttle cut is canceled and no longer active in the first condition, as long as the second condition does not have throttle cut active.

- Touch the [Throttle Cut] button in the Linkage Menu to call the setup screen shown below.

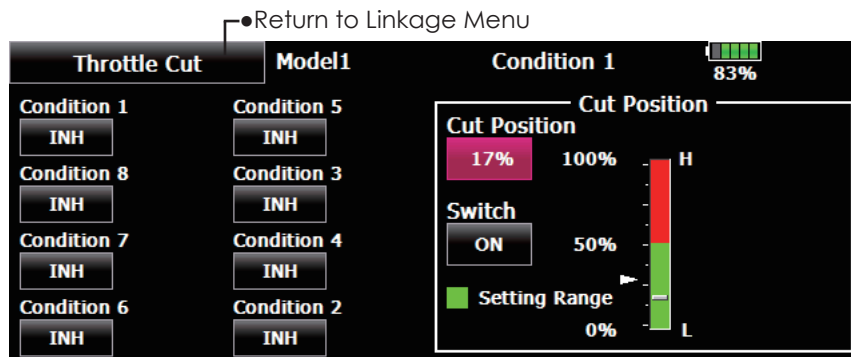

(The display screen is an example. The screen depends on the model type.)

Throttle cut setting procedure

1. To set up Throttle cut in Conditions, select the Condition number and touch the "INH" button.
2. Throttle cut function switch setting:
Touch the "NULL" button to call the <Switch> screen, and then select the switch and its ON direction.
(For a detailed description of the selection method, see [Switch Setting Method] at the back of this manual.)
3. Throttle cut position setting:
Set the throttle stick to maximum slow, and touch the Cut Position button. Adjustment buttons appear. At the same time, the numerical value of the current maximum

slow side is displayed at "Cut Position".

Use the adjustment buttons to adjust the servo travel when the throttle cut function is activated.

- Initial value: 17%
- Adjustment range: 0%~50%

*With throttle stick at idle, adjust the rate until the engine consistently shuts off, but throttle linkage is not binding. When finished, touch the "Throttle Cut" button to exit.

To exit the setting, touch the [Throttle Cut] button.

Idle Down

Lowers the engine idling speed.(airplane and helicopter only)

The Idle Down function lowers the engines idle by flipping a switch with the throttle stick at idle. The action is not functional at high throttle to avoid accidental dead sticks. The switch's location and direction must be chosen, as it defaults to NULL.

- Touch the [Idle Down] button in the Linkage Menu to call the setup screen shown below.

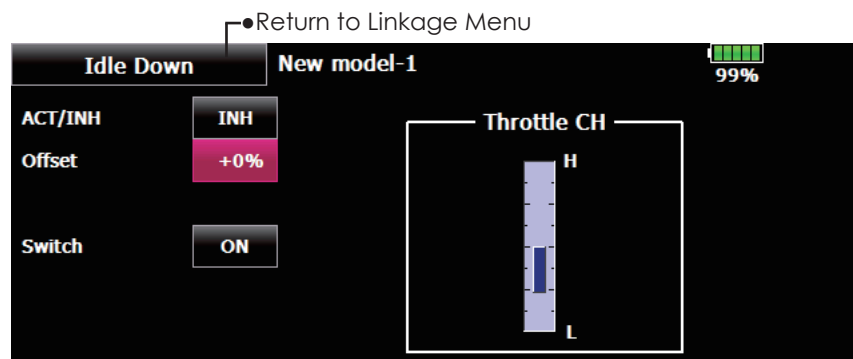

(The display screen is an example. The screen depends on the model type.)

Idle down setting procedure

1. Touch the "INH" button to activate the Idle Down function.
2. Idle Down function switch setting:
Touch the "NULL" button to call the <Switch> screen, and then select the switch and its ON direction.
(For a detailed description of the selection method, see [Switch Setting Method] at the back of this manual.)
3. Offset rate setting:
Touch the Offset Rate button. Adjustment buttons appear on the screen.
Use these buttons to adjust the offset rate.
 - Initial value: 0%
 - Adjustment range: -100%~100%*(-)becomes an idle up.

To exit the setting, touch the [Idle Down] button.

Swash Ring

Limits the swash travel within a fixed range to prevent linkage damage (Helicopter only)

This function limits the travel of the swash plate to prevent linkage damage as the aileron and elevator operation is used. It is useful for 3D heli setting.

- Touch the [Swash ring] button in the Linkage Menu to call the setup screen shown below.

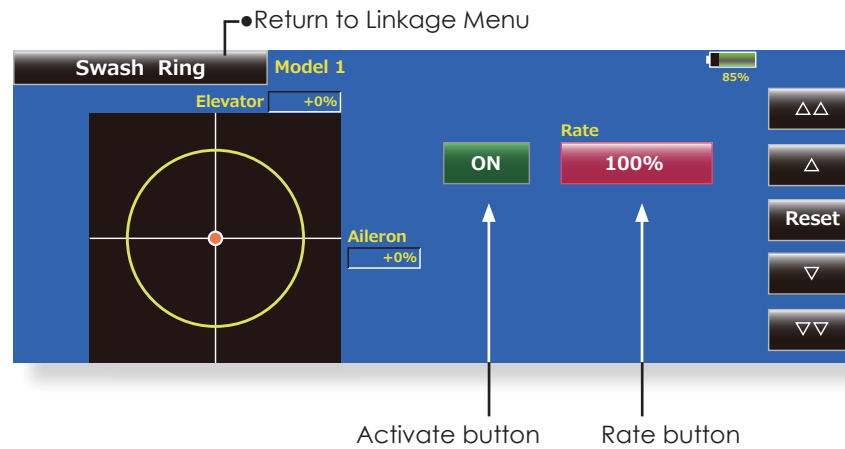

Swash ring setting procedure

1. Push the Swash ring button on the linkage menu.
2. Push ACT/INH button to activate.
 - *The movement area monitor shows the current aileron and elevator values and limit ranges by the yellow circle.
3. Adjust the rate to the maximum amount of swash plate decline.
 - *The swash movement is limited within the circle.
 - Adjustment range: 50 - 200%.

Swash

Swash operation linkage correction function
(This swash setup screen does not appear for swash type H-1.)

Neutral Point

On your linkages, if the servo horn deviates from perpendicular at neutral, the linkage compensation functions may not work effectively. This neutral point setting reads the linkage compensation neutral position. However, this adjustment only changes the reference point of the compensation function on the swash details screen and does not affect the neutral position of other functions.

*Before using the compensation function, set the neutral point.

Swash AFR

The swash AFR function adjusts (increases/decreases/reverse) the rate (travel) of the aileron, elevator, and pitch functions.

Mixing Rate

(Normally, the default value is used.)

This mixing rate is used for minor correction to the swash plate so that it moves in the correct direction for aileron, elevator, and pitch operation.

Compensation mixing is shown below.

*PIT->AIL/PIT->ELE/AIL->PIT/ELE->AIL/ELE->PIT

*Use the corresponding compensation mixing and adjust so that the swash plate moves in the correct direction

Linkage Compensation

This compensation mixing is used to adjust for interference when the ailerons or elevators are operated when the throttle stick was in the low or high position.

Speed Compensation

This speed compensation function make adjustments for interference when the travel of each servo is different due to swash plate operation. For HR-3, it compensates the speed by dropping the operating speed of the aileron and pitch servos during elevator operation.

- Touch the [Swash] button in the Linkage Menu to call the setup screen shown below.

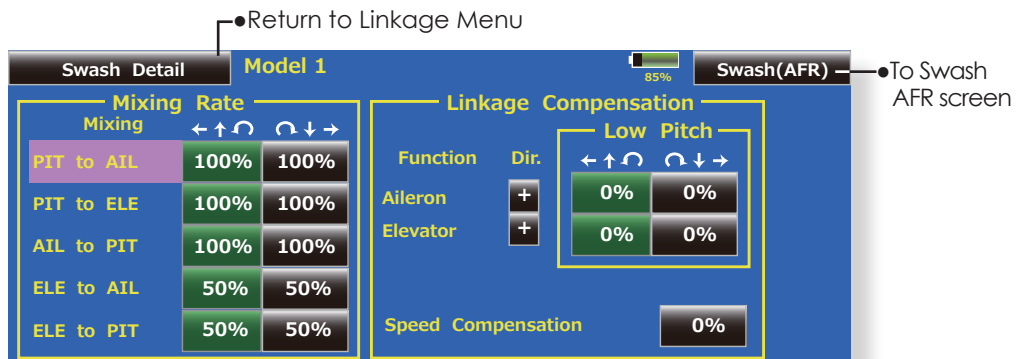
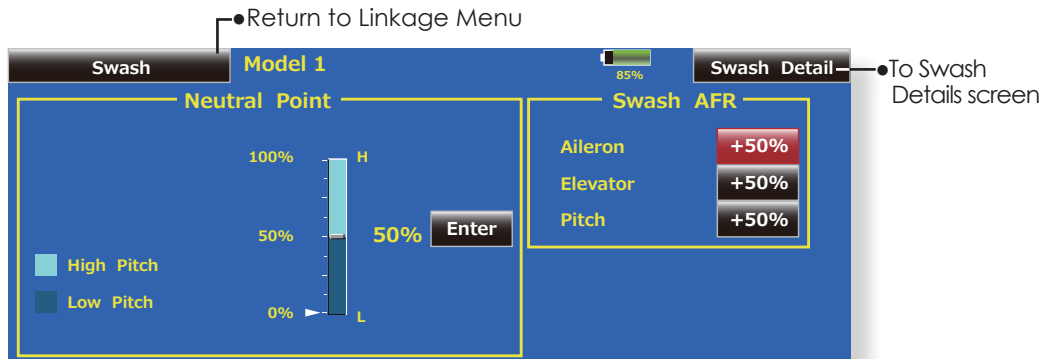

Neutral point setting procedure

- *Becomes the compensation reference point.
 - *Adjusting the servo horn so that the neutral point position is near the 50% position makes the mixing amount small.
1. Hold the servo horn at a right angle to the linkage rod, and then touch the [Enter] button and read the actual neutral point.
 - *The neutral point is displayed on the screen.
- After reading this neutral point, use other compensation functions to make further adjustments.

To exit the setting, touch the [Swash] button.

Swash AFR setting procedure

- Adjust so that the specified operation amount is obtained by aileron, elevator, and pitch operation.
1. Touch the button of the AFR rate to be adjusted. Adjustment buttons appear on the screen.
 2. Use the adjustment buttons to adjust the AFR rate.
 - Initial value: +50%
 - Adjustment range: -100%~+100%
 - +or- The direction of operation changes.
- To exit setting, touch the [Swash] button.

Mixing rate setting procedure

- HR-3 is described as an example. The mixing applied in other swash modes is different, but the setting procedure is the same.
1. Set the throttle stick to the set neutral point. Adjust the length of the linkage rod so that the swash plate is horizontal at this position.
 - *A little adjustment using sub trim should be OK.
 - *Adjust so that pitch operation when the pitch curve is straight is maximum.
 2. Adjust the AIL->PIT amount so there is no interference in the elevator or pitch direction when the aileron stick is moved to the left and right.
 - *Adjust the left and right sides separately.
 3. Adjust the ELE->AIL and ELE->PIT amounts so there is not interference in the aileron or pitch direction when the elevator stick is moved up and down.
 - *Adjust the up and down sides separately.
 4. Adjust the PIT->AIL and PIT->ELE amounts so that the swash plate is horizontal when the throttle stick is set to maximum slow and full high.
 - *Adjust the slow and high sides separately.
- To exit setting, touch the [Swash Details] button.

Linkage correction setting procedure

- *Set the linkage compensation after setting the mixing rate.
 - *This function compensates for elevator interference by aileron operation or aileron interference by elevator operation at Low pitch and Hi pitch at collective pitch (HR3, etc.) control.
 1. Set the throttle stick to the maximum slow position. Move the aileron stick to the left and right and adjust the aileron compensation amount so that interference in the elevator or pitch direction at that time is minimal.
 - *The left and right sides can be adjusted separately.
 - *If the interference increases when the compensation amount is increased, make the compensation direction "-".
 2. Adjust the elevator compensation amount so that the interference in the aileron or pitch direction when the elevator stick was moved up and down is minimal.
 3. Perform aileron and elevator compensation similarly for the throttle stick full high side.
- To exit setting, touch the [Swash Details] button.

Speed compensation setting procedure

1. Set the throttle stick to the neutral point position. Move the elevator stick quickly and adjust the speed compensation amount so that the interference in the pitch direction is minimal.
 - To exit setting, touch the [Swash Details] button.

Notes:

If the linkage is too long or short, correct compensation will not be applied. Correct this before continuing. The pitch angle changes after any adjustment. Reset the pitch angle when actually flying after compensation processing.

Timer Timer setting and lap time display.

The Timer function may be set for any desired time, i.e. engine run time, specified times for competitions, etc. Two independent timers are provided for your use. The timers are stored independently with each model, meaning that when you switch between model setups, the timer associated with the new model is brought up automatically.

The timers may be set to start and stop from the motion of any switch or stick. You may set the ON and OFF directions freely. Each timer has a capacity of up to 59 minutes 59 seconds.

Each timer may be set for count-down or count up operation with your choice of a target time. Also Split Time may be set up and counted.

If a target time is set and the timer reaches this point, a buzzer will sound for each count is generated.

Countdown timers sound one short beep during the last twenty seconds and two short beeps during the last ten seconds before reaching the target, then a long tone at the target time, and continue counting with displaying a minus (-) sign. Count-up timers also beep the last twenty and ten seconds, beep the target time, and keep counting upwards until shut down.

- Touch the [Timer] button in the Linkage Menu to call the setup screen shown below.

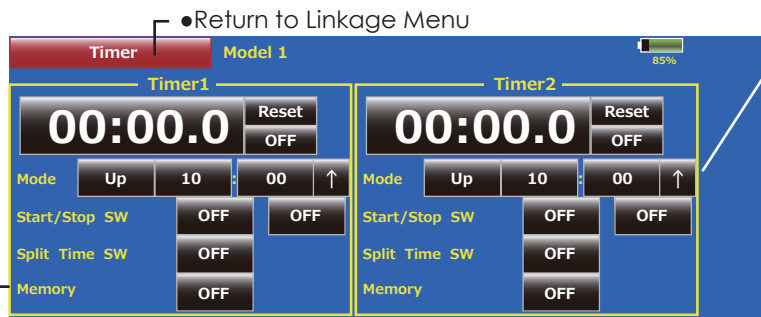

•Return to Linkage Menu

[↑] An alarm sounds every minute of the elapsed time from timer start. (Conventional mode)

[↓] An alarm sounds every minute of the remaining time up to the alarm time.

- Memory is turned ON, the power OFF and a model change will not be reset timer, either.

<Lap time list>

Lap#	Split Time	Lap#	Split Time	Lap#	Split Time	Lap#	Split Time
1	00:00.0	7	00:00.0	13	00:00.0	19	00:00.0
2	00:00.0	8	00:00.0	14	00:00.0	20	00:00.0
3	00:00.0	9	00:00.0	15	00:00.0	21	00:00.0
4	00:00.0	10	00:00.0	16	00:00.0	22	00:00.0
5	00:00.0	11	00:00.0	17	00:00.0	23	00:00.0
6	00:00.0	12	00:00.0	18	00:00.0	24	00:00.0

•Return to Timer screen

Up timer/Down timer/Hour selection

1. Touch the mode button and select the type of timer.
2. Timer time setting
Touch the Mode minutes or seconds button. Adjustment buttons appear on the screen. Use these buttons to set the timer time.

Start/SWtop switch setting

1. Touch the Start/Stop SW "NULL" button to call the <Switch> screen, and then select the switch and its ON direction.

(For a detailed description of the selection method, see [Switch Setting Method] at the back of this manual. The timer switches can be set for each condition.)

Lap time switch selection

1. Touch the Lap SW "NULL" button to call the Prog. Mix screen, and then select the switch and its ON direction.

(For a detailed description of the switch setting method, see [Switch Setting Method] at the back of this manual. The timer switches can be set for each condition.)

Timer operation

- Timer 1 and Timer 2 are started and stopped by your choice of switch.
- To count the lap time, select the lap time switch. Each time this switch is operated, the lap time is stored. To display the lap time, touch the respective [List] button.
- To reset a timer, touch the respective [Reset] button. To exit the setting, touch the [Timer] button.

Hour mode

An HOUR mode which counts up to 99 hours 50 minutes has been added to the timer modes.

- This mode is convenient when used at engine maintenance period and other long-term measurements.
- When the HOUR mode is set, "xx(hour) : xx(minute)" is displayed on the count time display. Seconds are not displayed.
- When the HOUR mode is set, ":" blinks each second during timer operation.
- When the HOUR mode is set, the alarm function/lap time measurement function are inhibited.

Dial Monitor

LDisplays the position of the dials, slider levers, and digital trim.

Digital trim position display (T1-T6, CD)

The Dial Monitor displays the current position and step amount of each Digital Trim. The trim step can be set directly on the dial monitor.

Digital trim step amount (T1-T6, CD)

The trim step of the T1-T6 and CD can be set directly on the dial monitor menu.

VR and slide lever position display (LST, LS, LD, RD, RS, RST)

Displays the current position (black▼) and last operating position (green▲) of the VRs and slider levers.

- Touch the [Dial Monitor] button in the Linkage Menu to call the setup screen shown below.

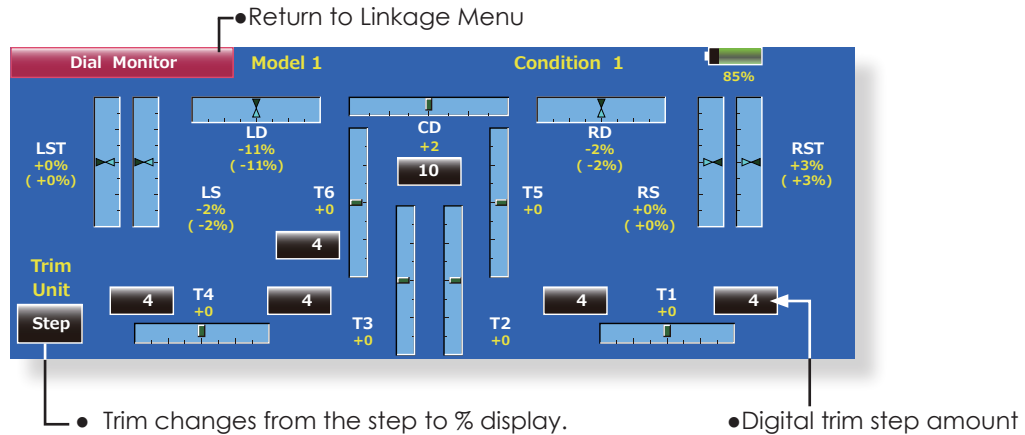

Knob and Lever Position display (LD, RD, LS, LST, RS, RST)

The Dial Monitor displays the current position and last operating position of each knob and lever. Although neither knob nor lever can hold the last operation position as they are “analog” type, the position data during the last operation is memorized in the model memory. By moving the knob and lever to the position displayed on the monitor, the last operation position is recalled.

Recalling Dial Position (LST, LS, LD, RD, RS, RST)

The dial position data at the last operation is displayed for each knob and lever in this monitor. (Green arrow)

1. Move the black arrow (current position) to the green arrow position by operating the desired knob or lever to recall the last operating position.

Function Name

Function Names can be changed in this menu.

The setup screen will display function names in both 10 and 4 characters.

- Touch the [Function Name] button in the Linkage Menu to call the setup screen shown below.

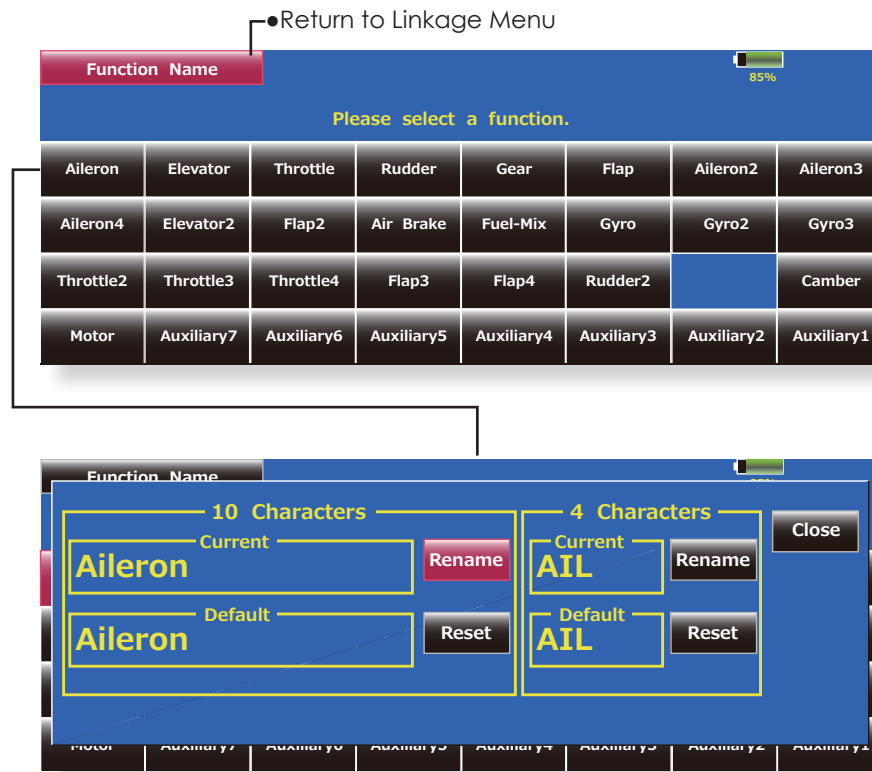

Procedure for changing the functions name

1. Select [Function Name] from the Linkage Menu.
2. Select the function whose name you want to change.
3. Press the [Rename] button and enter the name in 10 characters and 4 characters each from the displayed keyboard. After the characters are entered, press the [Return] key.
4. When the [Reset] key is pressed, the function name is reset its original name.

Telemetry

Displaying data from the receiver

This screen displays your choice of data from the receiver.

Also warnings can be activated regarding the data. For example, if the receiver voltage drops, the user can be warned by an alarm.

Warning

Do not watch the transmitter screen during flight.

*You may lose sight of the aircraft during flight and this is extremely dangerous. Have an assistant on hand to check the screen for you. A pilot should NEVER take his eyes off his aircraft.

- Call the following setting screen by pressing the [Telemetry] button of the Linkage Menu.

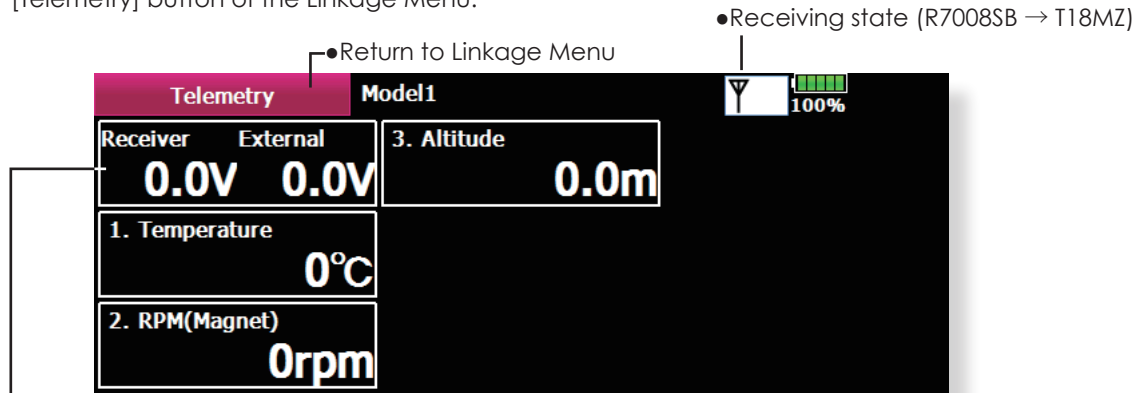

Receiver Battery Display

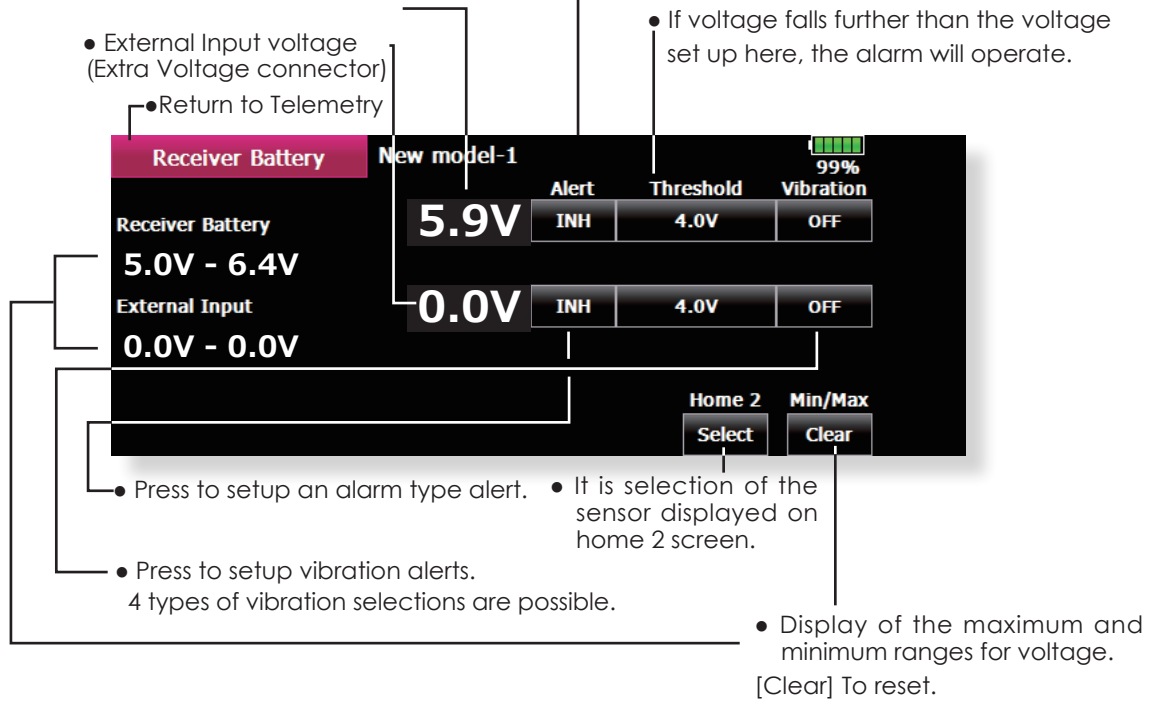

Temperature Display

The screenshot shows the 'Temperature' menu for 'New model-1'. The main display shows '0°C'. The menu includes options for 'Alert' (INH), 'Threshold' (100°C), and 'Vibration' (OFF). Below these are 'Unit' (°C), 'Home 2' (Select), and 'Min/Max' (Clear) options. A battery indicator shows 99%.

- Temperature Display
- Return to Telemetry
- If the temperature reaches higher than the temperature set up here, the alarm will operate.
- Press to setup an alarm type alert.
- Press to setup vibration alerts. 4 types of vibration selections are possible.
- It is selection of the sensor displayed on home 2 screen.
- It is display change from Centigrade[°C] to Fahrenheit[°F]
- Display of the maximum and minimum ranges for temperature. [Clear] To reset.

RPM Display

The screenshot shows the 'RPM' menu for 'New model-1'. The main display shows '0rpm'. The menu includes options for 'Alert' (INH), 'Threshold' (2000rpm), and 'Vibration' (OFF). Below these are 'Type' (Magnet), 'Gear Ratio' (1.00), 'Home 2' (Select), and 'Maximum' (Clear) options. A battery indicator shows 99%.

- RPM Display
- Return to Telemetry
- If RPM goes higher than the RPM set here, the alarm will operate.
- Press to setup an alarm type alert.
- Press to setup vibration alerts. 4 types of vibration selections are possible.
- It is selection of the sensor displayed on home 2 screen.
- Select the type: Either optical sensor or magnetic sensor. In an optical sensor, the number of fins is entered. In a magnet sensor, the gear ratio is entered.
- Display of the maximum and minimum ranges for RPM. [Clear] To reset.

Altitude Display

Atmospheric pressure is measured by a sensor. The actual altitude is measured in regards to the difference between the ground and atmospheric pressure.

Atmospheric pressure when the power supply of the altitude sensor is set to ON is displayed as a standard (0 m).

[Reset] Push the button to re-set to a standard altitude.



What altitude is it?

- Variometer Display : How many meter rise (descent) in 1 second.
- Atmospheric pressure Display
- Altitude Display
- Press to setup an alarm type alert.
- If Altitude becomes higher than the Altitude set here, the alarm will operate.
- Press to setup vibration alerts. 4 types of vibration selections are possible.
- Return to Telemetry
- If Preset is pushed, the present atmospheric pressure = altitude of 0 m.
- It is selection of the sensor displayed on home 2 screen.
- Display of the maximum and minimum ranges for Altitude. [Clear] To reset.

Home2 Display

Three telemetry data can be displayed on Home2 screen. The item to display can be set up.

Display	Slot	Sensor Type
1 ON	0	Receiver
2 ON	1	Temperature
3 ON	2	RPM

- It is displayed by [ON] Undisplayed is carried out in [OFF.]
- The slot number of the telemetry data displayed on Home2 screen is set up.

Sensor

Various telemetry sensors setting.

The telemetry sensor slot No. and which sensor is used in each slot can be changed in this screen.

Since the sensor in each slot is determined at initialization and the same slot No. is memorized even for sensors sold separately, sensors can be used by simply connecting them to S.BUS2. When customizing the sensors yourself, perform the settings in this screen.

*Three slots of altitude sensor are used.

- Touch the [Sensor] button in the Linkage Menu to call the setup screen shown below.

[What is a slot?]

Servos are classified by CH, but sensors are classified in units called "slot". There are slots from No. 1 to No. 31.

Altitude sensors and other data sensor units may use multiple slots.

By the sensor which uses two or more slots, the required number of slots is automatically assigned by setting up a start slot.

When 2 or more of the same kind of sensor are used, the sensors themselves must allocate unused slots and memorize that slot.



Procedure for changing the sensor of each slot No.

1. Select [Sensor] from the Linkage Menu.
2. Select the sensor of the slot No. to be changed.
3. Select the type of displayed sensor.
4. When the [Yes] key is pressed, the type of sensor is changed.

*In the case of a sensor which uses more than one slot, you may be unable to reassign.

Procedure for changing the slot No. of each sensor unit

1. Select [Sensor] on page 2 of the Linkage Menu.
2. Call page 2 by pressing [1/2] and press [Change Slot].
3. Connect the receiver battery and the sensor unit to the S.I/F connector behind the rear cover of the transmitter using a 3-way hub or 2-way cord.
4. Press the [Read] key. The current slot No. is displayed.
5. When a number is pressed, the [△], [▽], [△△] and [▽▽] keys appear. Now change the desired No.
6. When the [Write] key is pressed, the desired No. is written to the sensor

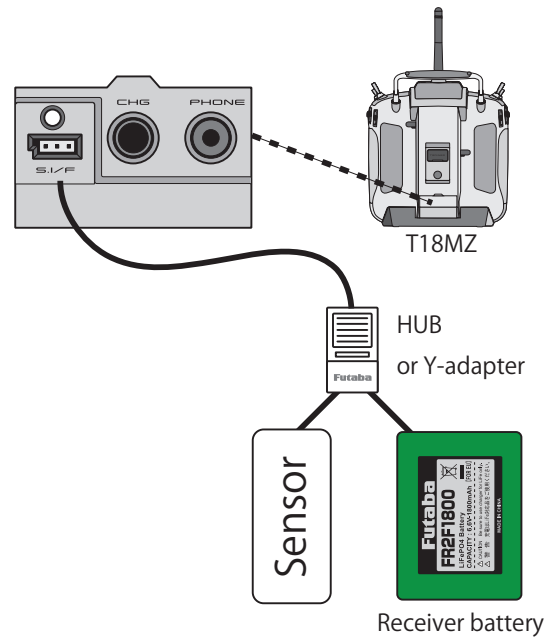

- Call this screen by switching to page 2 by pressing the [1/2] button on the Sensor screen and then pressing [Change Slot].

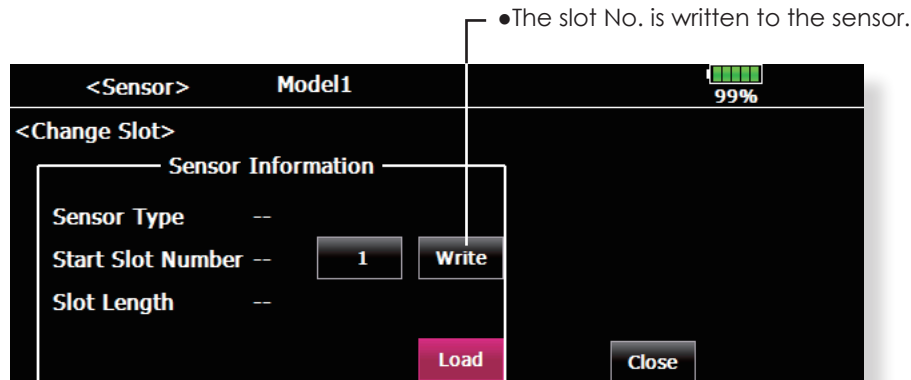

- When pressed, the current slot No. is displayed.
- The slot No. is written to the sensor.
- Returns to the Sensor screen.

Warning

Setting of warning sound and vibration

A warning upon powering up your transmitter can be set up for the following functions.

Default setting is ON. Leave ON any function in which it seems that you feel is dangerous upon power up.

The alarm is stopped at power up if the function is changed to OFF.

* If a throttle stick turns on a power supply at full throttle as in the case of the electric craft, it may begin to turn to the prop at high rotation suddenly, and this is very dangerous. We recommend you set the throttle position warning to ON.

- Touch the [Warning] button in the Linkage Menu (2/2) to call the setup screen shown below.

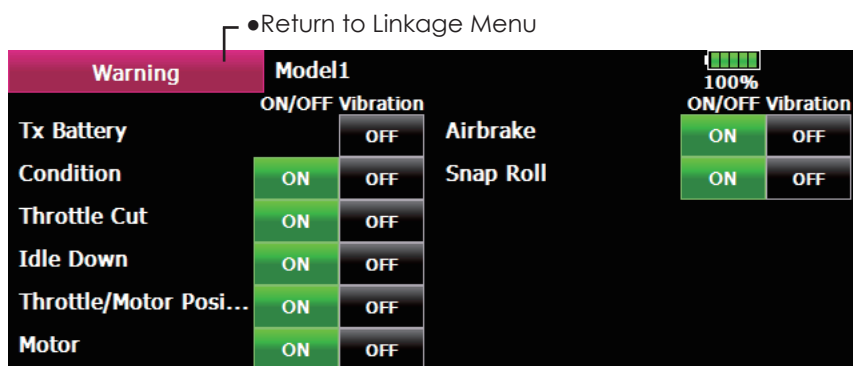

- If this is turned On, the alarm will be a vibration in the transmitter when you power on the radio.
- If this is changed to OFF, alarm will not sound during powering up of your transmitter.

- If a throttle stick is above low throttle when you power on your transmitter, the next screen will appear and an alarm will sound. You should never power up your transmitter with the throttle stick above fully closed for safety's sake.



- If you lower your throttle stick when you see this warning, the confirmation screen will appear and ask if you would like to Transmit. If you wish to transmit, press YES.

Data Reset

Model memory setting data reset. (by item)

This function is designed to allow you to reset selected portions or all of the settings saved in the active model memory. You may individually choose to reset the following sets of data;

T1~T6, CD:

Reset the digital trim setting.

*All the conditions, or the condition currently being displayed (the entire group for group setting), can be selected.

Direct key:

Resets direct key assignment.

Model menu setting:

Resets all the functions in the Model Menu except Condition Select.

All model setting:

Resets all Linkage and Model Menu functions except for System Type, Model Select, and Model Type.

Function Name:

A function name is reset.

- Touch the [Data Reset] button in the Linkage Menu to call the setup screen shown below.

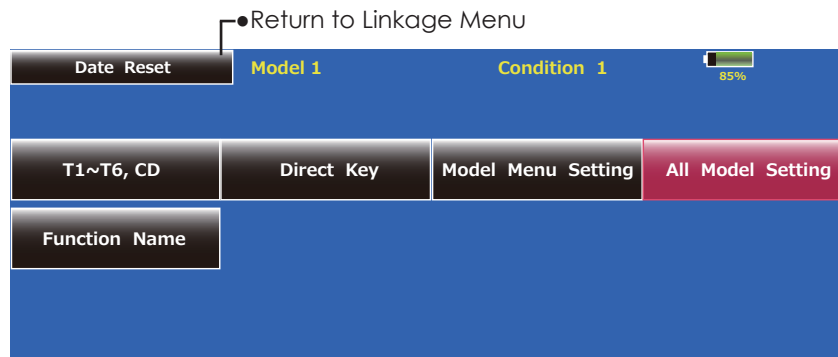

Data Resetting

1. Touch the desired button to reset the data.
2. Perform the data reset according to the instructions displayed on a screen. When complete, touch the Data Reset button to exit.

! Default setting of the motor channel will be reversed once a reset is complete.

Condition Hold

Condition hold function (Helicopter only)

This function may be used to limit the maximum speed of the engine so that you may adjust flight conditions when the engine is running. An alarm indicates that the function is operating. It will prevent the engine from racing dangerously when adjusting the Idle-Up settings.

While this function is active, the throttle servo position is fixed at the point that you have indicated when the function is activated. You must deactivate this function when you are through making adjustments.

The system will not allow you to activate/deactivate this function in either of the following states:

- When any of the flight condition switches are on.
- When the throttle stick is higher than the 1/3 point.

To activate/deactivate Condition hold:

(Home screen)

1. Set the throttle stick lower than the 1/3 point.
2. Push the direct key S4 (Cond. Hold) to activate the condition hold function.

*When this function is active, "Condition Hold is active" appears on the screen.

(LINKAGE menu/MODEL menu)

1. Set the throttle stick lower than the 1/3 point.
2. Push the INH (or the direct key S4) button to activate the condition hold function.

*Operation is displayed at the bottom of the menu.

Function ON: "ON" is displayed.

Function OFF: "INH" is displayed.

MODEL MENU (COMMON FUNCTIONS)

This section describes the AFR, program mixing, and other functions common to all model types.

Before setting the model data, use the Model Type function of the Linkage Menu to select the model type matched to the fuselage. When another model type is selected thereafter, the AFR, program mixing, and other setting data are reset.

The functions in the Model Menu can be set for each flight condition. When you want to use the system by switching the settings for each condition by switch, stick position, etc., use the Condition Select function to add flight conditions. (Up to 8 conditions can be used)

Note: The T18MZ is designed so that the airplane and glider (including EP glider) model types are compatible with fuselages of similar type wings. This section outlines the relationship between the functions common to airplanes and gliders, except some dedicated functions, and model type. The setting items depend on the number of servos and other differences according to the wing type used, but reread them. The setup screens in the instruction manual are typical examples.

- Touch the Model Menu button of the Home screen to call the Model Menu.
- When the button of the function you want to set is touched, a setup screen appears.

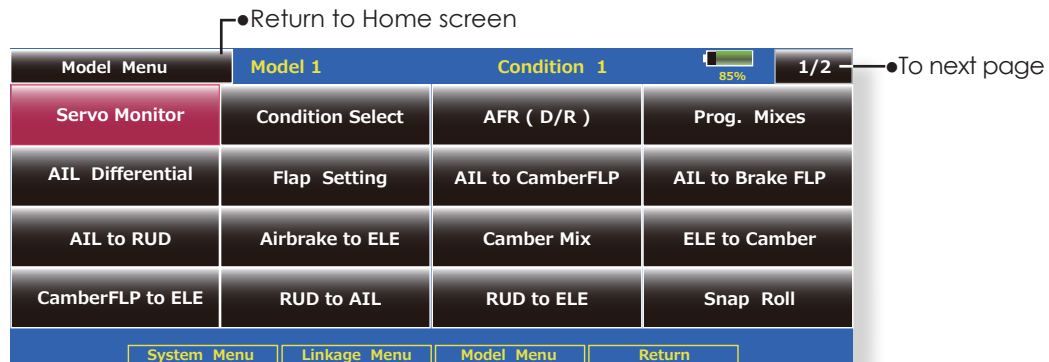

(Model Menu screen example)

*The Model Menu screen depends on the model type. This screen is for model type Airplane Wing Type 4AIL+4FLP.

Model Menu functions (Common) list

•Servo Monitor

Servo test and servo position display (For a description of its functions, see the Linkage Menu section.)

•Condition Select

Flight conditions addition, deletion, copy, condition renaming, and condition delay can be set.

•AFR (D/R)

Sets the rudder angle and curve of all the operation functions. A D/R curve which can be switched with a switch, etc. can also be added.

•Prog. Mixes

Program mixing which can be freely customized. Up to 10 mixes can be used for each condition.

•Fuel Mixture

Mixing used in needle adjustment of engines which use a fuel mixture control carburetor. [Airplane, helicopter]

Condition Select

Flight conditions addition, deletion, copy, condition renaming, and condition delay can be set. [All model types]

The functions in the Model Menu can be used by switching the settings of up to 8 flight conditions by using the Condition Select function to add flight conditions. Add conditions, as required.

When you do not want to use the Condition Select function, this setting is unnecessary. In this case, use the flight conditions (Condition 1) assigned at initial setting.

- Since switching by stick and lever position, in addition to ordinary toggle switch, is possible as the flight condition selector switch, this function can be linked with other operations.
- A Condition Delay function can be set. Unnecessary fuselage motion generated

when there are sudden changes in the servo positions and when there are variations in the operating time between channels during condition switching can be suppressed. The delay can be set for each channel.

When setting the delay function at the switching destination condition, the related function changes after a delay corresponding to the set amount.

- When multiple conditions are set, their operation priority can be freely changed.
- The condition name can be changed. The selected condition name is displayed on the screen. When a condition has been added, give it a name which can be easily confirmed.

- Touch the [Condition Select] button in the Model Menu to call the setup screen shown below.

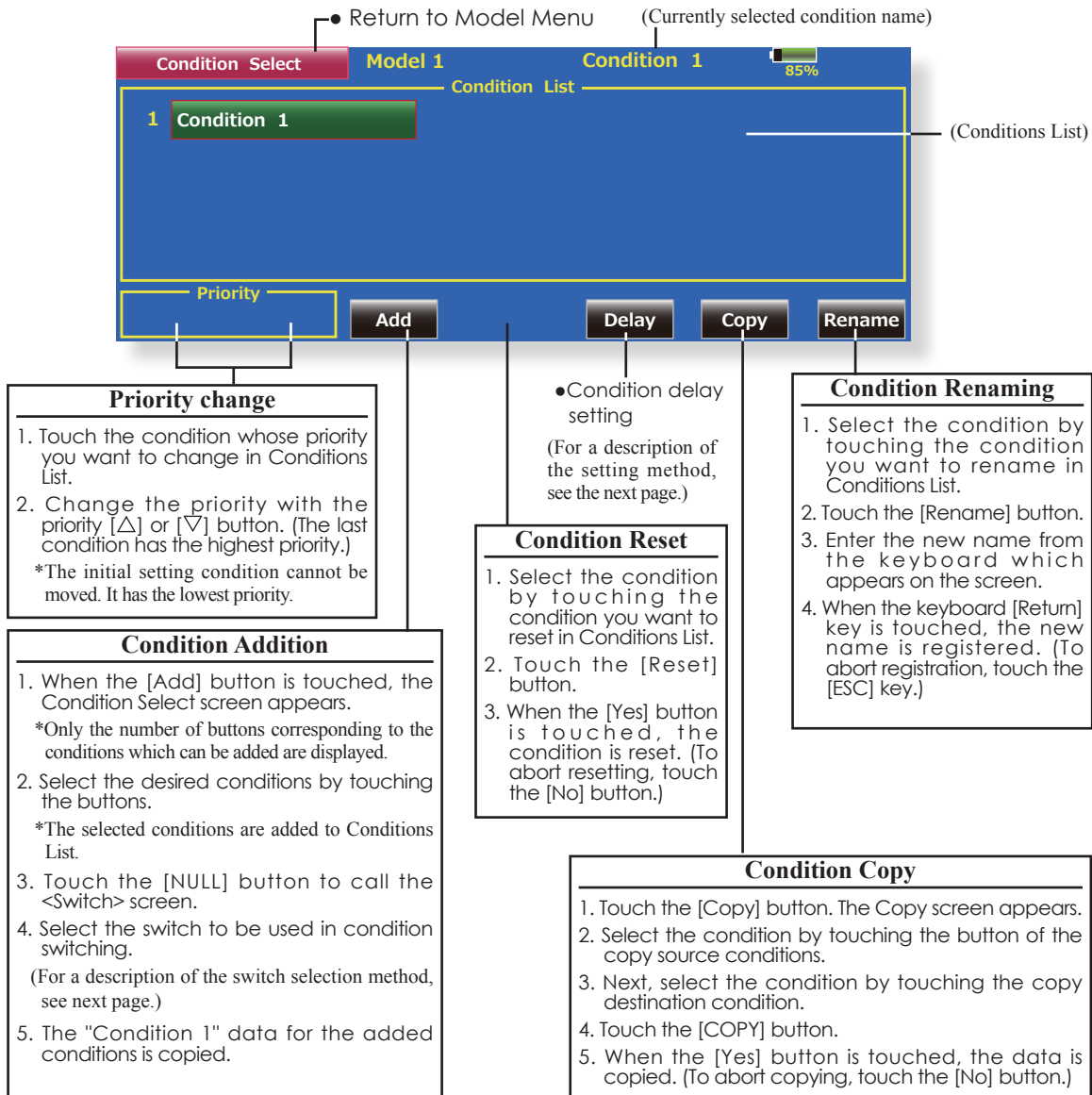

Condition switch setting and ON/OFF direction switching

*For a description of the selection method, see [Switch Setting Method] at the back of this manual.

- Touch the [Delay] button on the Condition Select screen to call the Condition Delay screen shown below.

• Return to Condition Select screen (Currently selected condition name)

Condition Delay			Model1-1	Normal			100%		
Ch	Function	Delay	Ch	Function	Delay	Ch	Function	Delay	
1	Aileron	0	7	Governor	0	13	Auxiliary2	0	
2	Elevator	0	8	Governor2	0	14	Auxiliary3	0	
3	Throttle	0	9	Gyro2(AIL)	0	15	Auxiliary4	0	
4	Rudder	0	10	Gyro3(ELE)	0	16	Auxiliary5	0	
5	Gyro(RUD)	0	11	Needle	0				
6	Pitch	0	12	Auxiliary1	0				

Condition delay setting

1. Switch to the condition you want to set.
2. Touch the Delay button of the channel you want to set.
3. Use the adjustment buttons to set the delay.
 - Initial value: 0
 - Adjustment range: 0~27 (maximum delay)

- Group/single mode switching (Gr./Sngl)
(For a description of the operation method, see the description at the back of this manual.)

AFR (D/R)

The rudder angle and curve of each operation function can be set. A D/R curve which can be switched by switch, etc. can also be added. [All model types]

AFR function is used to adjust the throw and operation curve of the stick, lever, and switch functions (CH1 to CH16) for each flight condition. This is normally used after End Point (ATV) has defined the maximum throw directions (End Point acts on ALL flight condition settings). When mixing is applied from one channel to another channel, both channels can be adjusted at the same time by adjusting the operation rate through the AFR function.

Setting method

- Operation curve adjustment: Six types of curves (linear, EXP1, EXP2, VTR, line and spline) can be selected. A maximum 17 points curve can be used for the line and spline curve types. (Initial setting: 9 points) The number of points can also be increased and decreased and curves from complex curves to simple curves can be used.
 - Operation speed adjustment: The operation speed of each function when the function is operated (including at flight condition switching) can be adjusted. The function operates smoothly at a constant speed corresponding to the set speed.
- Touch the [AFR (D/R)] button in the Model Menu to call the setup screen shown below.

(Currently selected rate name: AFR, D/R1~6)

Function selection

1. When the function select button is touched, a selection screen appears.
2. Select the function you want to set at the selection screen.

• Group/single mode switch (Gr./Sngl)
(For more information, see the description at the back of this manual.)

• Return to Model Menu (Currently selected condition name)

• Operation curve setting
(For a description of the setting method, see the description at the back of this manual.)

• Servo speed setting
(For a description of the setting method, see the description at the back of this manual.)

• D/R function setting

(Total number of AFR and D/R curves set in the currently selected condition)

Screen mode switching

When setting the D/R function, the screen display mode can be changed. Each time the button is touched, the mode is switched.

- *[Sngl](initial setting): Only the currently operating curve is displayed.
- *The AFR and D/R curves set at the currently operating condition are displayed.
- *[All Cond.]: The AFR curve set at all conditions is displayed.
- *[Selected AFR]: The selected function is displayed.

Dual Rate setting

Up to 6 dual rates can be set for each condition.

*D/R (Dual Rate) is set for each condition, and is not reflected at other conditions.

*D/R (Dual Rate) at the top of the D/R list has priority.

Setting method

- Touch the [D/R] button from the AFR (D/R) screen of the function (ailerons, elevators, etc.) whose dual rate you want to set. The D/R list screen shown below is displayed. Touch the (function) button of the dual rate number to be assigned. That rate is automatically assigned to that function.
- Next, select the switch and its ON/OFF directions.

Close

- At the end of each setting, touch the [Close] button.

Start D/R1

- To start D/R1, touch the [INH] button.

Function change

- When the aileron button is touched, the system asks for a [Yes] or [No]. To change the function, switch to the function selected at the AFR screen by answering [Yes].

Naming D/R1

1. To name D/R1, touch the [D/R1] button. A keyboard appears on the screen.
2. Enter the desired name from this keyboard and register it by touching the keyboard [Return] key. To cancel input and close the screen, touch the [ESC] key.

Switch setting

1. Touch the [NULL] button. The <Switch> screen appears.
2. Select (confirm) the switch and its ON direction.

Setting example

- Rudder ON/OFF by switch. When D/R is used by using the condition with the same switch, another rudder angle can be set.

Since the functions shown below are used in special types of setups, AFR (D/R) cannot be chosen.

- *Aileron2, Aileron3, Aileron4
- *Flap2, Flap4
- *Rudder2
- Throttle(Only helicopter)
- Pitch
- Camber
- Gyro(RUD), Gyro2(AIL), Gyro3(ELE)
- Governor
- Mixture
- *Elevator2
- Butterfly

*AFR (D/R) can be set up according to a wing type.

Prog. Mixes

Program mixing which can be freely customized. Up to 10 mixings can be used for each condition. [All model types]

Programmable mixing may be used to correct undesired tendencies of the aircraft, and it may also be used for unusual control configurations. Mixing means that the motion of a command channel, called the "master," is added to the motion of the mixed channel, called "slave."

You may choose to have the Masters trim added to the Slave channel response, if you desire ("Trim" setting). The mixing curve can be changed so that the undesired tendencies can be corrected effectively by setting the LINEAR1/LINEAR2/EXP1/EXP2/VTR/LINE/SPLINE modes. The Delay function can be programmed for each rate. The Delay is used to change the rate smoothly when switching. You may define Mixing ON/OFF switch, control or you may choose to

have mixing remaining on all the time.

Offset-type mixing applies a fixed offset or preset to the programmed channel servo operation and may control up to four circuits simultaneously.

The Programmable mixing includes a powerful link function, which allows Programmable mixing to be linked with the special mixing functions, or with other programmable mixing functions. The link function can be set up for Master and Slave channel individually.

The slave channel AFR mode (STK-STK mode) may be selected, where the slave channel AFR and D/R settings are observed when Link function is set. The knob for fine tuning can be set up for every mixing circuit. (Fine tune function)

- Touch the [Prog. Mixes] button in the Model Menu to call the setup screen shown below.

Return to Model Menu

Mixing buttons
After this function is activated, the master and slave function names (or offset mixing) are displayed.

- Switch selection
- Servo speed setting

Group/single mode switching (Gr./Sngl)
(For more information, see the description at the back of this manual.)

- Mixing mode change button

(Curve-type mixing) (Offset-type mixing)

(Timer mode)

Operation curve setting

Fine tuning trim setting

(Normal mode)

Timer mode
The on time (start/stop time) can be set up to 9 seconds. It is useful for landing gear control of the jet or scale plane, etc.

Setting methods

●Group/single mode selection

Activating functions for only the selected conditions:

1. Touch the Group button and switch to the Sngl mode.

*Each time the button is touched, it toggles between the Gr. and Sngl modes.

●Mixing mode selection

Using the offset mode:

1. Touch the Mode button and switch to the Offset mode.

*Each time the button is touched, it toggles between the Mix and Offset modes.

●Mixing setup screen selection

1. Touch the button of the mixing you want to set. The mixing setup screen is displayed. Activate the function.

2. Activate the function by touching the [INH] button.

*Each time this button is touched, it toggles between [INH] and [ON/OFF].

●Mixing ON/OFF switch setting and ON/OFF direction switching

*An ON/OFF switch is not set even when the function is activated.

1. When you want to turn mixing ON/OFF by switch, touch the [NULL] button to call the <Switch> screen and then select the switch and its ON direction.

*For a description of the selection method, see [Switch Setting Method] at the back of this manual.

●Master channel setting (except offset type mixing)

1. Touch the Master button to call the Function menu and select the master channel.

2. To link this mixing with other mixing, touch the button at the left of the master channel and select link.

*Each time the button is touched, it toggles between mixing direction + and - and "No display" (no link).

*Master channel control can be set to stick, VR, and other simple travels which do not include ATV, AFR, D/R, mixing setting, etc. In this case, display the <Switch> screen by touching the [H/W] button and then select master channel side control.

●Slave channel setting

1. Touch the Slave button to call the Function menu and select the slave channel.

2. To link this mixing with other mixing, touch the button at the right-hand side of the slave channel and select link.

*Each time the button is pressed, it toggles between mixing direction + and - and "No display" (no link).

●Trim mode ON/OFF setting

1. To turn the trim mode ON/OFF, touch the Trim button on the screen.

*When mixing includes master side trim, set the Trim button to [ON]. When mixing does not include master side trim, set the Trim button to [OFF].

*Each time this button is pressed, it toggles between [ON] and [OFF].

*This is effective when the master channel is set by Function.

●Slave channel AFR mode (STK→STK)

1. When Link is set at the slave side, and you want to add AFR (D/R) to the mixing rate, select [ON]. When you do not want to add AFR (D/R) to the mixing rate, select [OFF].

*Each time this button is pressed, it toggles between [ON] and [OFF].

*This is effective when making corrections when the fuselage is the same but the rudder angles are substantially different.

●Mixing curve type selection

1. Touch the curve type selection button of the curve type you want to use to display the selection screen and then select the curve you want to use.

*For a description of the curve setting method, see the description at the back of this manual.

●Fine tuning trim setting

1. When using the curve fine tuning function, touch the [NULL] button of the Fine Tuning item to call the <Switch> screen and then select the lever, VR, etc. you want to use.

*For a description of the fine tuning trim setting method, see the description at the back of this manual.

●Servo speed setting

1. When setting the servo speed, touch the Speed button. The Servo Speed setup screen is displayed.

*For a description of the servo speed setting method, see the description at the back of this manual.

*Offset mixing changes the speed. Use the Speed In and Speed Out buttons to readjust the speed..

The mixing switch can set a delay with a different rate at starting and stopping.

*This function is inactive when a mixing switch is not set.

- The programmable mixing (in mixing mode) STK to STK mixing function can be used even when the Master function is controlled by a stick or other hardware.

Fuel Mixture

Dedicated mixing used in needle adjustment of engines which use a fuel mixture control carburetor. [Airplane, helicopter]

This function is dedicated mixing used in needle adjustment of an engine that uses a fuel mixture control carburetor.

*The needle channel is assigned to CH9 as a default.

- Touch the [Fuel Mixture] button in the Model Menu to call the setup screen shown below.



- Operation curve setting

(For a description of the setting method, see the description at the back of this manual.)

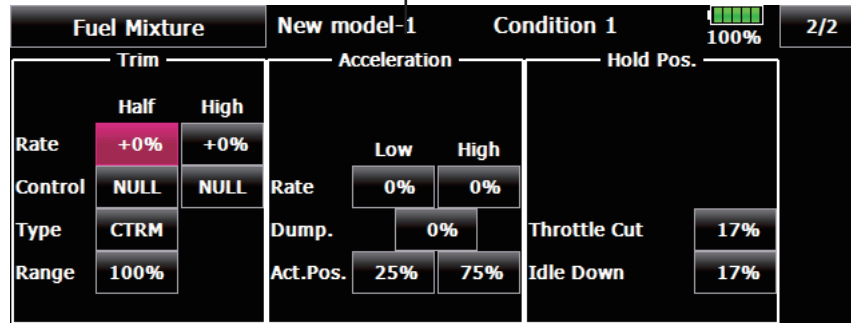

Setting method

CTRM mode: Maximum change near center by center trim operation (Does not change at end of the stick movement) When the adjustment range (Range) value is made small, trim is active only near the center.

NORM mode: Normal trim (linear) operation. When the adjustment range value is decreased, trim is active only near the center. Needle high trim works as high trim based on the center. This operation is similar to reverse ATL trim.

1. An acceleration function can be set. This is used when the mixture is either too rich or too lean, which can be caused by sudden operation of the throttle stick.
2. The return time after operation (Dump) can

3. be set for both settings (Acceleration-High) .
 3. A needle throttle cut function can be set.
 4. This operation can be linked with the throttle hold functions (Cut and Idle), Throttle Cut function, and Idle Down.
 5. The needle side cut position can be set. Set it to the fuel side full open position.
- When **MIX** mode is selected, the throttle curve setting becomes the master.
- In the **UNMIX** mode, the throttle stick position becomes the master.

MODEL MENU (AIRPLANE/GLIDER FUNCTIONS)

These are the menus usable when either airplane, glider, or EP glider model type have been selected, are displayed in the Model Menu screen. First use the Model Type function of the Linkage Menu to select your model type, wing type, and tail type. Changing these later will reset any data set in this menu.

These dedicated mixings can be set for each flight condition, as required. When you want to use the system by switching the settings for each condition by switch or stick position, use the

Condition Select function to add flight conditions. (Up to 8 conditions can be used)

Note: The T18MZ is designed so that the airplane and glider (including EP glider) model types can handle fuselages of the same wing type. The functions common to airplanes and gliders, except for a few specific functions, are shown below. Items may be different, depending on the number of servos, etc. and according to the wing type used. However, reread them. The setup screens in the instruction manual are typical examples.

- Touch the Model Menu button of the Home screen to call this Model Menu.
- When the button of the function you want to set is touched, a setup screen appears.

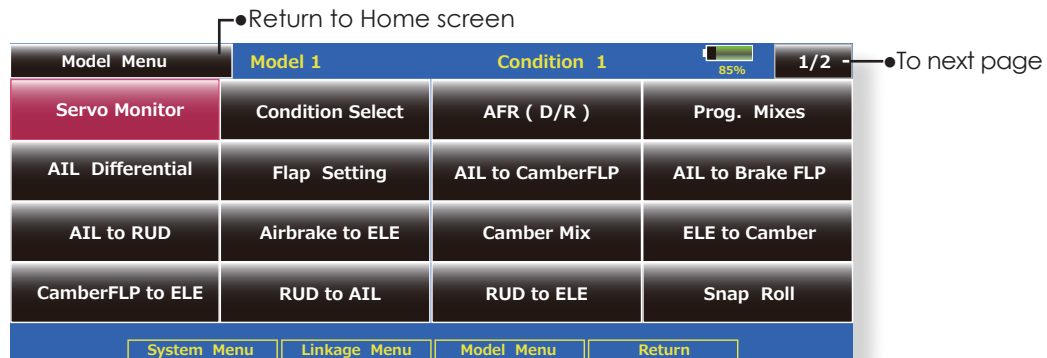

(Model Menu screen example)

*The Model Menu screen depends on the model type. This screen is for model type Airplane Wing Type 4AIL+4FLP.

Model Menu functions list

•AIL Differential

This function adjusts the left and right ailerons. Roll axis correction and fine tuning with a VR are also possible. This is convenient when making settings during flight.

[Airplane/glider, 2 ailerons or more]

•Flap Setting

The flaps can be adjusted independently. For a 4 flaps model, the camber flaps can be mixed with the brake flaps. [Airplane/glider, 2 flaps or more]

•AIL to Camber FLP

This mixing operates the camber flaps in the aileron mode. It improves the operation characteristic of the roll axis. [Airplane/glider, 2 ailerons + 2 flaps or more]

•AIL to Brake FLP

This mixing operates the brake flaps in

the aileron mode. It improves the operation characteristic of the roll axis. [Airplane/glider, 4 flaps or more]

•AIL to RUD

This mixing is used when you want to operate the rudder with aileron operation. Banking at a shallow bank angle is possible. [Airplane/glider, 2 ailerons + 2 flaps or more]

•Airbrake to ELE

This mixing is used to correct operation of the airbrakes (spoilers) when landing. [Airplane/glider, general]

•RUD to AIL

This mixing is used to correct roll maneuvers, knife edge, etc. of stunt planes. [Airplane/glider, general]

● **Camber Mix**

This mixing adjusts the camber and corrects the elevators. [Airplane/glider, 2 ailerons or more]

● **ELE to Camber**

This mixing is used when you want to mix camber flaps with elevator operation. Lift can be increased with raised elevators. [Airplane/glider, 2 ailerons or more]

● **Camber FLP to ELE**

This mixing is used to correct for attitude changes when the camber flaps are being used. [Airplane/glider, 2 ailerons + 1 flap or more]

● **Butterfly (Crow)**

This function is used when powerful brake operation is necessary. [Glider, 2 ailerons or more]

● **Trim Mix 1/2**

The ailerons, elevators, and flaps trim offset rate can be utilized by a switch or condition selection. [Glider, 2 ailerons or more]

● **Airbrake**

This function is used when airbrakes are necessary when landing or when diving during flight. [Airplane, general]

● **Gyro**

This is dedicated mixing when a gyro is used. [Airplane/glider, general]

● **V-tail**

This function adjusts the elevators and rudder of V-tail models. [Airplane/glider, V-tail specifications]

● **Ailevator**

This function adjusts the elevators and ailerons of models with elevator specifications. [Airplane/glider, elevator specifications]

● **Winglet**

This function adjusts the left and right rudders of winglet models. [Airplane/glider, winglet specifications]

● **Motor**

The operation speed when the motor of F5B and other EP gliders is started by switch can be set. [EP glider, general]

● **RUD to ELE**

This function is used to correct roll maneuvers, knife edge, etc. of stunt planes. [Airplane, general]

● **Snap roll**

This function selects the snap roll switch and adjusts the steering angle of each rudder. Servo speed can also be adjusted. [Airplane general]

● **Multi Engine**

This function adjusts the throttles independently when using a multi engine model. (Maximum 4 engines) [Airplane, general]

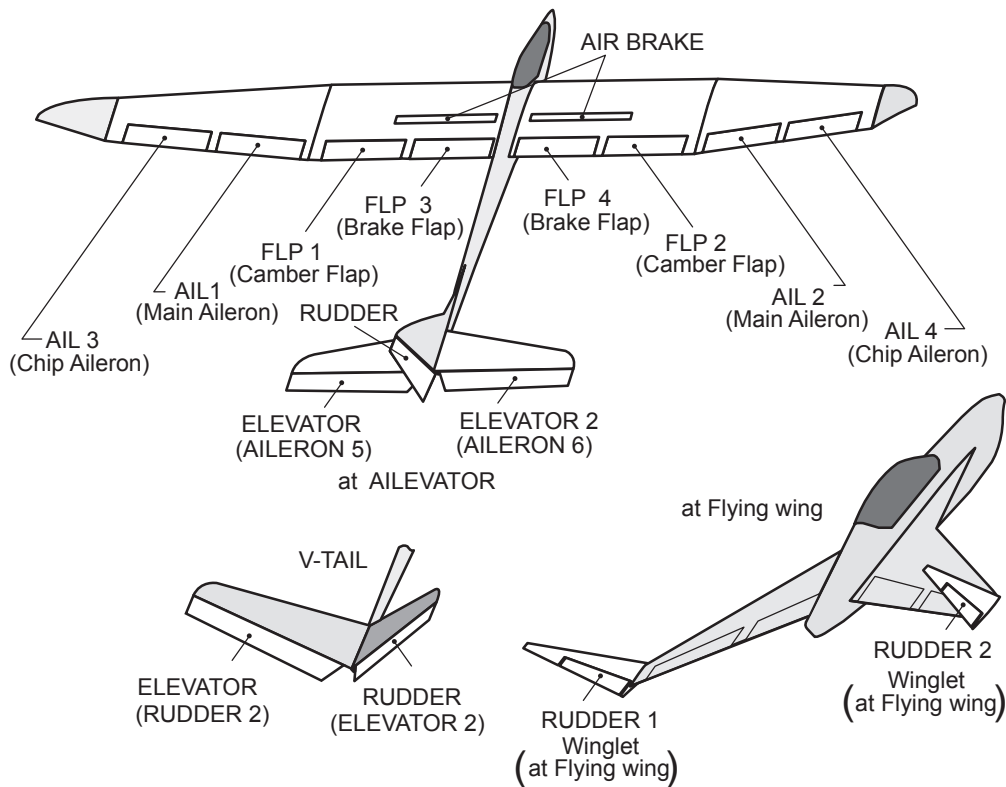

AIL Differential [Airplane/glider, 2 ailerons or more]

The left and right ailerons differential can be adjusted independently. The differential rate can also be adjusted according to the flying state by setting a fine tuning VR.

- A fine tuning curve can be set.

Note: Aileron up/down setting (%) reset is +100% when reset when setting is +, and -100% when reset when setting is -. Left and right mixing causes + and - to change. Before flying, confirm the direction of operation.

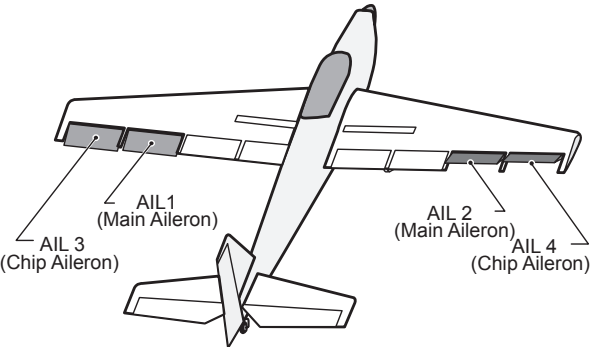

- Touch the [AIL Differential] button in the Model Menu to call the setup screen shown below.

<Wing type: 4 ailerons screen>

*The display screen is an example. The actual screen depends on the Model Type.

- Calls the AFR screen directly when adjusting aileron operation AFR.

AIL Differential Model 1 Condition 1 85% Master

	Left	Right
AIL	100%	100%
AIL2	100%	100%
AIL3	100%	100%
AIL4	100%	100%
Fine Tuning	NULL	

POS: +0.0% RATE: +0.0%

Linear Separate
Rate A Rate B
+100.0% +100.0%
Offset
+0.0%

Gr. (Group/Single mode switching)

Return to Model Menu

Overall adjustment by Rate A and Rate B.

Fine tuning curve setting (For a description of the setting method, see the description at the end the manual.)

Fine tuning VR setting
*The graph is operated by setting a VR, etc.

Aileron left/right adjustment
*The display is reversed by mixing with aileron operation

*The display is reversed by mixing with aileron operation

Group/single mode switching (Gr./Sngl)
(For more information, refer to the description at the back of this manual.)

Setting method

- Touch the aileron (AIL) 1~4 left (or right) button, and adjust the aileron angles when the stick is moved to the left (or right) end.
- *The aileron AFR screen can be directly called from the AIL Differential setup screen. ([Master] button)
- When setting the fine tuning VR, touch the "NULL" button to call the <Switch> screen, and then select the fine tuning VR.
- The fine tuning rate can be set by curve.

Flap Setting [Corresponding model type]: Airplane/glider, 2 flaps or more

The up/down travel of each flap (camber flaps: FLP1/2, brake flaps: FLP3/4) can be adjusted independently at each servo according to the wing type.

- The operation reference point of each flap can be offset

The camber flaps of a 4-flap model can be mixed with the brake flaps. (Brake FLP to camber FLP)

- An ON/OFF switch can be set.

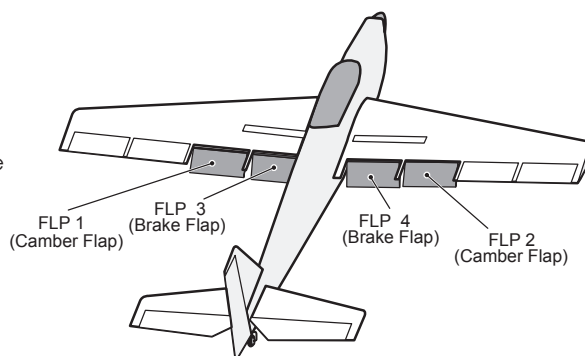

- Touch the [Flap Setting] button in the Model Menu to call the setup screen shown below.

- Group/single mode switching (Gr./Sngl)

(For more information, see the description at the back of this manual.)

<Wing type: 4 flaps screen>

*The display screen is an example. The actual screen depends on the model type.

•Return to Model Menu

Camber Flap		Brake Flap		B.Flap to C.Flap	
Group	Gr.	Group	Gr.	Group	Gr.
UP	+100%	UP	+100%	UP	+100%
Down	+100%	Down	+100%	Down	+100%
Offset	+0%	Offset	+0%	Offset	+0%

•Operation reference point offset

•Up side/Down side adjustment

Setting method

- Touch the flap (FLP) 1~4 Up or Down button according to the wing type and adjust the travel independently.
- To offset the operation reference point of each flap, touch the corresponding Offset button. Use the adjustment buttons displayed on the screen to offset the reference point.
- When using Brake FLP to Camber FLP mixing, touch the ACT button and set the function to ACT (ON). When setting a switch, touch the [ON] button of the switch to call the <Switch> screen, and then select the switch and set its ON direction. (Always ON at "ON" setting)
(For a description of the switch selection method, see the description at the back of this manual.)

AIL to Camber FLP

[Corresponding model type]: Airplane/glider, 2 ailerons + 2 flaps or more

This mixing operates the camber flaps (FLP1/2) in the aileron mode. When the aileron stick is manipulated, the ailerons and camber flaps move in aileron operation simultaneously and the roll axis is improved.

- The aileron left/right mixing rate of each flap servo can be fine-tuned.
- A mixing curve can be set.
- An ON/OFF switch can be set.
- Linking to other mixes is possible.

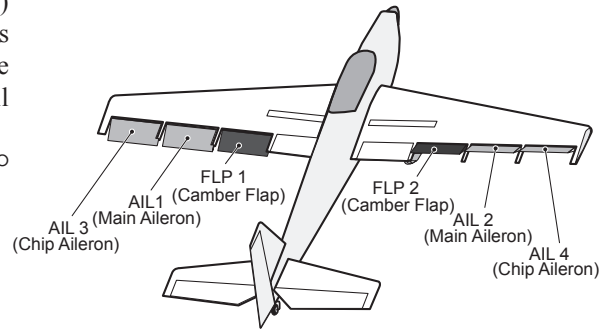

- Touch the [AIL to Camber FLP] button in the Mode Menu to call the setup screen shown below.

*The display screen is an example. The actual screen depends on the model type.

Setting method

- Touch the ACT button and set the function to ACT (ON).
- When setting a switch, touch the [ON] button of the switch to call the <Switch> screen, and then select the switch and set its ON direction. (Always ON at "ON" setting)
(For a description of the switch selection method, see the description at the back of this manual.)
- Touch the left or right button of each flap servo, and adjust the mixing rate with the adjustment buttons.

*When the mixing direction is reversed due to linkage setup, adjustments can be made by changing the rate value from + to - (positive to negative).

- A mixing curve can be set.
(For a description of the mixing curve setting method, see the description at the back of this manual.)
- To set linking, touch the Link button and set it to ON.

AIL to Brake FLP [Corresponding model type]: Airplane/glider, 4 flaps or more

This mixing operates the brake flaps (FLP3/4) in the aileron mode. When the aileron stick is manipulated, the aileron and brake flaps perform the aileron operation simultaneously and the performance of the roll axis is improved.

- The aileron left and right mixing rates can be adjusted for each flap servo.
- A mixing curve can be set.
- Mixing during flight can be turned ON/OFF by setting a stick. (Always ON at "ON" setting)
- Linking can be set: Links this mixing to other mixings.

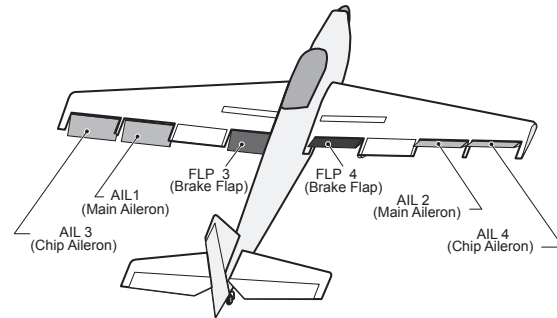

- Touch the [AIL to Brake FLP] button in the Model Menu to call the setup screen shown below.

*The display screen is an example. The actual screen depends on the model type.

AIL to Brake FLP Model 1 Condition 1

ACT INH Gr. 85%

Switch OFF

Link INH

	Left	Right
FLP3	+0%	+0%
FLP4	+0%	+0%

POS +0.0% RATE +0.0%

Linear Separate

Rate A Rate B

+100.0% +100.0%

Offset +0.0%

• Return to Model Menu

• Left/right overall adjustment by Rate A and Rate B

• Adjustment of each flap servo

• Mixing curve setting

• Group/single mode setting (Gr./Sngl)

Setting method

- Touch the ACT button and set the function to ACT (ON).
- When setting a switch, touch the [ON] button of the switch to call the <Switch> screen, and then select the switch and set its ON direction. (Always ON at "ON" setting)
- Touch the left or right button of each flap servo, and adjust the mixing rate with the adjustment buttons.

*When the mixing direction is reversed due to linkage setup, adjustments can be made by changing the rate value from + to - (positive to negative).

- A mixing curve can be set.
- To set linking, touch the Link button and set it to ON.

AIL to RUD [Corresponding model type]: Airplane/glider, general

Use this mixing when you want to mix the rudders with aileron operation.

- A mixing curve can be set.
- Mixing during flight can be turned ON/OFF by setting a switch. (Always ON at "ON" setting)
- The mixing rate can be fine-tuned by setting a VR.

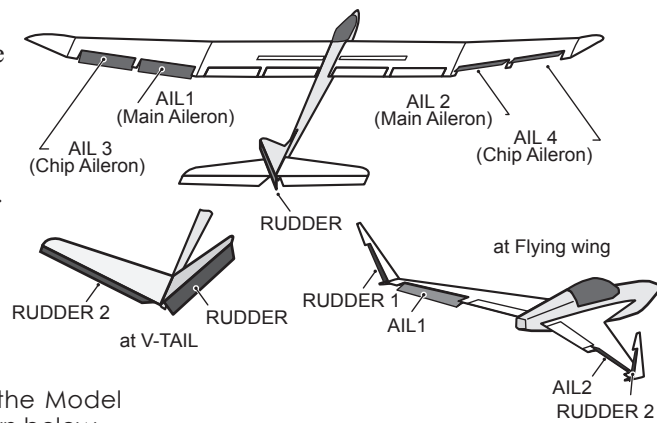

- Touch the [AIL to RUD] button in the Model Menu to call the setup screen shown below.
- *The display screen is an example. The actual screen depends on the model.

Setting method

- Touch the ACT button and set the function to ACT (ON).
- When setting a switch, touch the [ON] button of the switch to call the <Switch> screen, and then select the switch and set its ON direction. (Always ON at "ON" setting)
- When setting a VR, touch the Fine Tuning "NULL" button to call the <Switch> screen, and then select the VR. The adjustment rate and direction can be set. The VR operation mode can also be selected.
- A mixing curve can be set.
- The curve display mode can be changed.
Single : Displays the mixing curve only
Fine tuning : Displays the mixing rate of the fine tuning VR
All Cond. : Displays the mixing curve of all the conditions. (When conditions are set)

Fine tuning VR setting

- VR selection
- Rate adjustment
- Operation mode selection
- Adjustment direction setting

*Displayed at VR setting.

[Operation modes]

- Mixing rate 0% at center of VR. When the VR is turned counterclockwise and clockwise, the mixing rate increases and decreases, respectively.
- Mixing rate 0% at left end of VR. When the VR is turned, the mixing rate increases.
- Mixing rate 0% at right end of VR. When the VR is turned, the mixing rate increases.
- When the VR is turned to the left or right of the neutral position, the mixing rate increases.

Airbrake to ELE

[Corresponding model type]: Airplane/glider, general

This mixing is used when you want to mix the elevators with airbrake (spoiler) operation. It raises the elevators to correct for drooping of the nose during airbrake operation.

*This function does not operate when airbrake is not assigned.

- Rate 1 side/Rate 2 side mixing rate of the elevator servos can be adjusted.
- A mixing curve can be set.
- Mixing during flight can be turned ON/OFF by setting a switch. (Always ON at "ON" setting)
- The mixing rate can be fine-tuned by setting a VR.

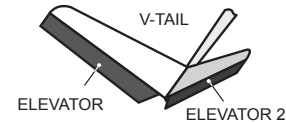
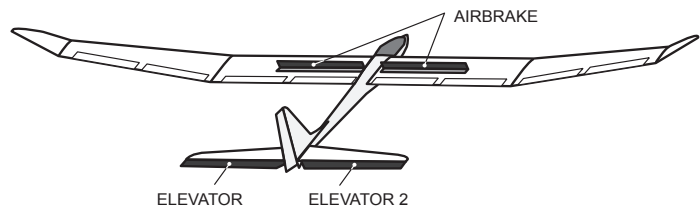

- Touch the [Airbrake to ELE] button in the Model Menu to call the setup screen shown below.

• Return to Model Menu

• Left/right overall adjustment by Rate A and Rate B

• Fine tuning VR setting

• Mixing curve setting

• Curve display mode switching (Single/Fine tuning/All Cond.)

• Group/single mode switch (Gr./Sngl)

Setting method

- Touch the "INH" button and set the function to ACT (ON).
- When setting a switch, touch the [ON] button to call the <Switch> screen, and then select the switch and set its ON direction. (Always ON at "ON" setting)
- When setting a VR, touch the Fine tuning "NULL" button to call the <Switch> screen, and then select the VR. The adjustment rate and direction can be set. The VR operation mode can also be set.
- A mixing curve can be set.
- The curve display mode can be set.
 Single : Displays the mixing curve only
 Fine tuning : Displays the adjustment rate of the fine tuning VR
 All Cond. : Displays the mixing curve of all the conditions. (When conditions are set)

RUD to AIL

[Corresponding model type]: Airplane/glider, general

This function is used when you want to mix the ailerons with rudder operation. It is used when rudder is applied during roll maneuvers, knife edge, etc. of stunt planes. It can be used to bank scale models, large models, etc. like a full size plane.

- A mixing curve can be set.
- Mixing during flight can be turned ON/OFF by setting a switch. (Always ON at "ON" setting)
- The rate of rudder correction can be memorized by using the memory function. This is convenient when setting a mixing curve. When memory operation (switch operation) is performed in memory mode with the rudder correction, the switch operation position at that time is displayed

on the mixing curve. When the memory mode is exited, the memorized points are automatically reflected on the curve. (When the memory function is used, "Line" type curve is automatically selected.)

- Linking can be set: Links this mixing to other mixings.
- The mixing rate can be fine-tune by setting a VR.

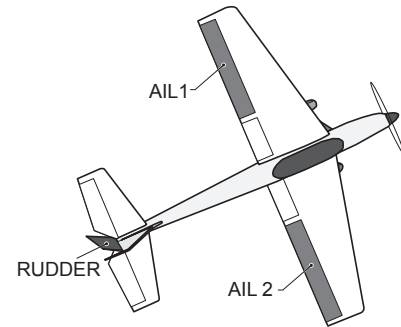

- Touch the [RUD to AIL] button in the Model Menu to call the setup screen shown below.

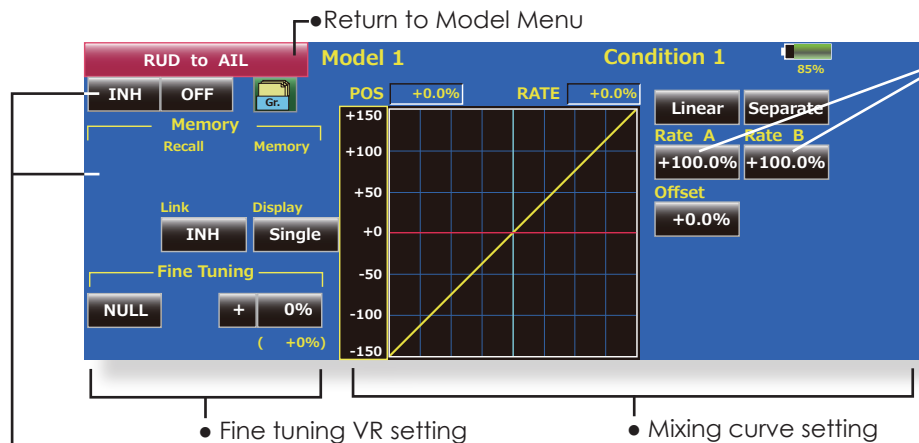

Overall adjustment by Rate A and Rate B.

- Return to Model Menu
- Fine tuning VR setting
- Mixing curve setting
- When set to ON by touching [INH], the memory items are displayed.

Setting method

- Touch the "INH" button and set the function to ACT (ON).
- When setting a switch, touch the [ON] button to call the <Switch> screen, and then select the switch and set its ON direction. (Always ON at "ON" setting)
- When setting a VR, touch the Fine tuning "NULL" button to call the <Switch> screen and then select the VR. The adjustment rate and adjustment direction can be set.
The VR operation mode can also be set.
- A mixing curve can be set.
- The curve display mode can be changed.
Single : Displays the mixing curve only
Fine tuning : Displays the adjustment rate of the fine tuning VR
All Cond. : Displays the mixing curve of all the conditions. (When conditions are set)
- When linking: Touch the Link button and set it to ON.

Memory function usage method

(Example) Using the memory function with an F3A airplane (knife edge correction)

*When call switch ⇒[SW-A] and memory switch⇒[SW-H] were set

[Memory function operation]

1. Memory function mode: [Manual]⇒[Memory]
2. When the memory switch (SW-H) was set to ON while performing aileron correction when rudder was applied at knife edge, the point position at that time is memorized. Perform memorization while changing the left and right stick positions.
3. To recall the memorized positions, set [SW-A] to ON. The memorized correction rate is reflected on the curve, and operation is simultaneously set.

Note: When memorized from manual before flight, be sure that the memory SW is not accidentally set to ON and incorrect mixing setting is not applied when taxiing, starting the engine, etc.

Camber Mix

[Corresponding model type]: Airplane/glider, 2 ailerons or more

This function adjusts the AFR (D/R) rate of camber operation which operates the wing camber (ailerons, camber flaps, brake flaps) in the negative and positive directions. The aileron, flap, and elevator rates can also be adjusted independently by curve, and attitude changes caused by camber operation can be corrected.

- Mixing during flight can be turned ON/OFF by setting a switch. (Always ON at "ON" setting)
- A delay can be set for each condition. A cut switch which can turn OFF the delay function can be set.
- The speed of the aileron, flap, and elevator servos can be set. (IN side/OUT side)

*Initial setting assigns camber operation to side lever RST(Stick Mode 2) LST(Stick Mode 1).

- The direction of the aileron, flap, and elevator servos can be adjusted by a curve. When direction is reversed at the linkage by this mix, you can reverse it by change the rates to either + or - (positive or negative).
- Touch the [Camber Mix] button in the Model Menu to call the setup screen shown below.

*The display screen is an example. The actual screen depends on the model type.)

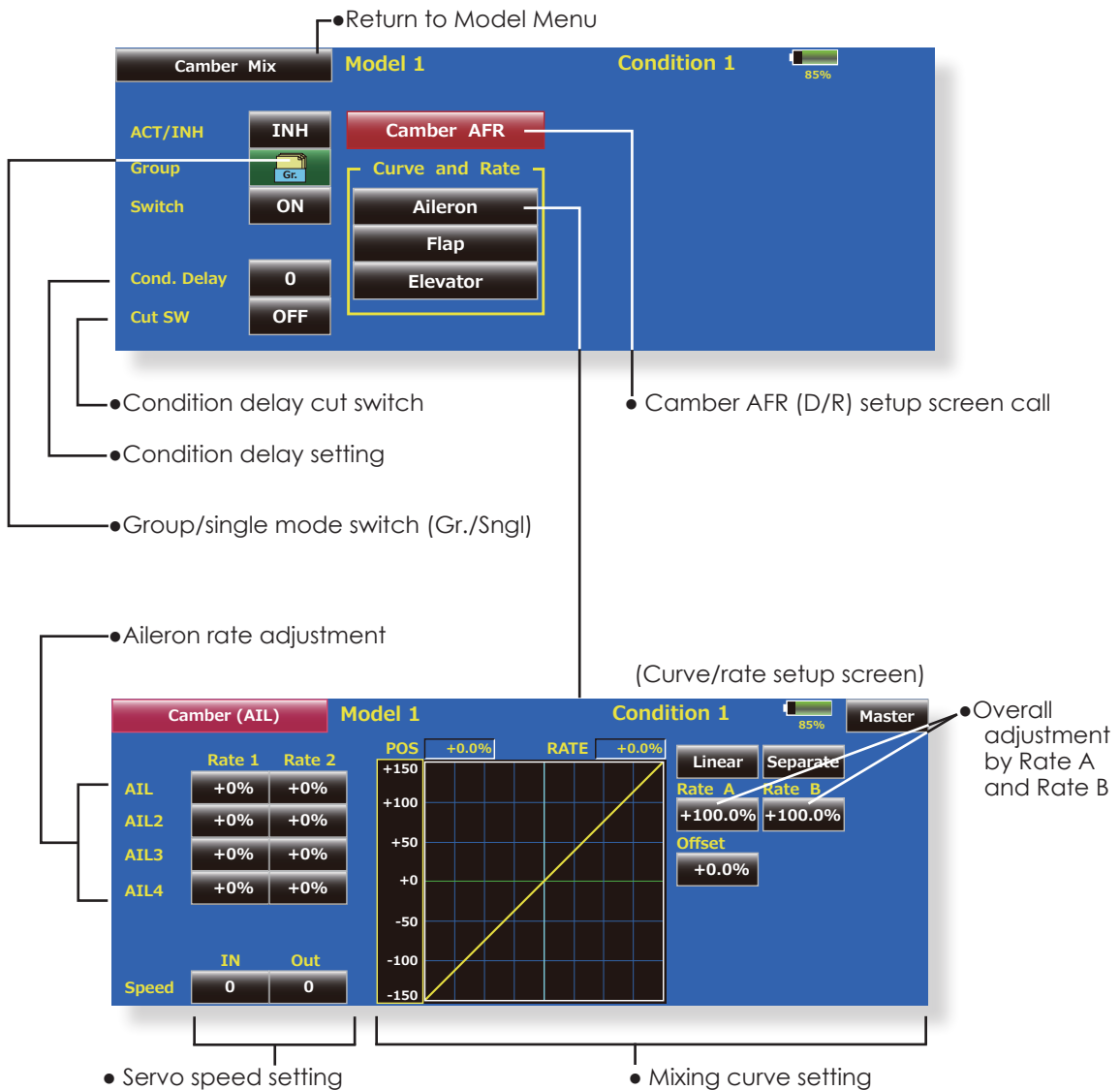

Setting method

- Touch the "INH" button and set the function to ACT (ON).
 - When setting a switch, touch the [ON] button to call the <Switch> screen, and then select the switch and set its ON direction. (Always ON at "ON" setting)
 - When setting a condition delay, touch the Condition Delay button and set the delay with the adjustment buttons which appear on the screen. The VR operation mode can also be set.
 - Camber AFR(D/R) screen call
Touch the Camber AFR button to call the setup screen.
- (Curve/rate setup screen)
- The curve and rate are adjusted by calling the aileron, flap, and elevator curve/rate screens. The rate and curve of each servo can be set by calling each screen. The servo speed can also be adjusted.

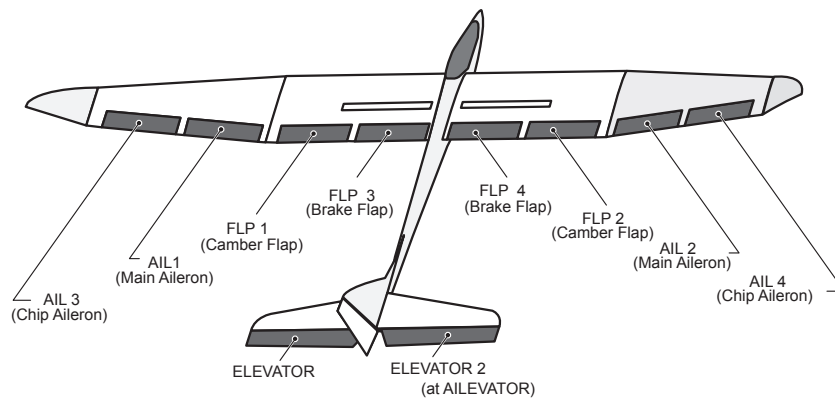

at V-TAIL

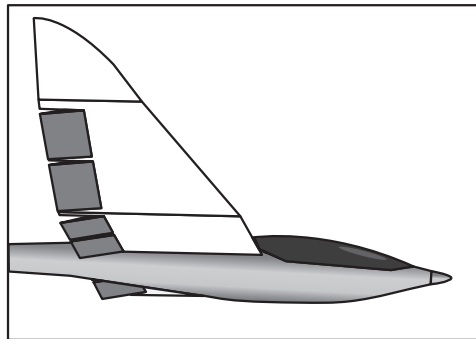
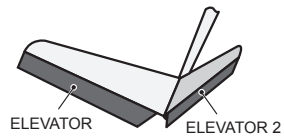

ELE to Camber

[Corresponding model type]: Airplane/glider, 2 ailerons or more

This function is used when you want to mix the camber flaps with elevator operation. When mixing is used so that the flaps are lowered by up elevator, lift can be increased.

- A mixing curve can be set.
- Mixing during flight can be turned ON/OFF by setting a switch. (Always ON at "ON" setting)
- The mixing rate can be fine-tuned by setting a VR.

- Touch the [ELE to Camber] button in the Model Menu to call the setup screen shown below.

	AIL3	AIL	AIL2	AIL4
Rate 1	+0%	+0%	+0%	+0%
	(+0%)	(+0%)	(+0%)	(+0%)
Rate 2	+0%	+0%	+0%	+0%
	(+0%)	(+0%)	(+0%)	(+0%)
Rate 1	FLP3	FLP	FLP2	FLP4
	+0%	+0%	+0%	+0%
	(+0%)	(+0%)	(+0%)	(+0%)
Rate 2	+0%	+0%	+0%	+0%
	(+0%)	(+0%)	(+0%)	(+0%)

(Ailerons and flaps rate adjustment screen)

Setting method

- Touch the ACT button and set the function to ACT(ON).
- When setting a switch, touch the [ON] button of the switch to call the <Switch> screen, and then select the switch and set its ON direction. (Always ON at "ON" setting.)
- When setting a VR, touch the Fine tuning "NULL" button to call the <Switch> screen, and then select the VR. The adjustment rate and adjustment direction can be set. The VR operation mode can also be selected.
- A mixing curve can also be set.
- The curve display mode can be changed.
 Single : Displays the mixing curve only
 Fine tuning : Displays the fine tuning VR adjustment rate
 All Cond. : Displays the mixing curve of all the conditions (When conditions are set)

Camber FLP to ELE

[Corresponding model type]: Airplane/glider, 2 ailerons + 1 flap or more

This mixing is used to correct changes (elevator direction) generated when the camber flaps (speed flaps) are used.

- The elevator servo rates can be adjusted. When the mix cause the servo direction to be reversed, adjustments can be made by changing the mixing rates at - to + (negative to positive).
- A mixing curve can be set.
- Mixing during flight can be turned ON/OFF by setting a switch. (Always ON at "ON" setting)
- The mixing rate can be fine-tuned by setting a VR.

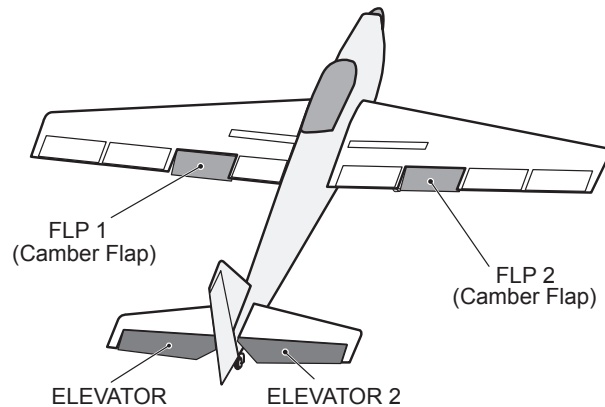

- Touch the [Camber FLP to ELE] button in the Model Menu to call the setup screen shown below.

*The display screen is an example. The actual screen depends on the model type.

- Group/single mode switching (Gr./Sngl)

The screenshot shows the 'CamberFLP to ELE' setup screen for 'Model 1' and 'Condition 1'. The screen is divided into several sections:

- Top Left:** 'CamberFLP to ELE' title, 'INH' button, 'OFF' button, and 'Gr' button.
- Top Right:** 'Model 1' and 'Condition 1' labels, a battery level indicator at 85%, and 'Linear' and 'Separate' buttons.
- Middle Left:** 'Rate 1' and 'Rate 2' settings, both set to '+0%' with '(+0%)' below them. Below these are 'ELE' and 'ELE2' settings, also set to '+0%' with '(+0%)' below them.
- Middle Right:** A graph with 'POS' on the y-axis (ranging from -150 to +150) and 'RATE' on the x-axis (ranging from -150 to +150). A yellow diagonal line represents the mixing curve. 'Rate A' and 'Rate B' are both set to '+100.0%'. Below the graph is an 'Offset' button set to '+0.0%'.
- Bottom Left:** 'Fine Tuning' section with 'NULL' and '+' buttons, and a 'Single' mode button.
- Bottom Right:** 'Fine tuning VR setting' and 'Mixing curve setting' labels.

Annotations with arrows point to various parts of the screen:

- 'Return to Model Menu' points to the top right corner.
- 'Overall adjustment by Rate A and Rate B' points to the 'Rate A' and 'Rate B' buttons.
- 'Fine tuning VR setting' points to the 'Fine Tuning' section.
- 'Mixing curve setting' points to the graph.
- 'Curve display mode switching (Single/Fine tuning/All Cond.)' points to the 'Single' button.
- 'Elevator rate adjustment' points to the 'ELE' and 'ELE2' buttons.

Setting method

- Touch the ACT button and set the function to ACT(ON).
- When setting a switch, touch the switch button to call the <Switch> screen, and then select the switch and set its ON direction. (Always ON at "ON" setting)
- Touch the elevator servos left and right buttons and adjust the mixing rate with the adjustment buttons displayed on the screen.

*When the mixing direction is reversed due to linkage setup, adjustments can be made by changing the rate value from + to - (positive to negative).

- When setting a VR, touch the Fine tuning "NULL" button to call the <Switch> screen, and then

select the VR.

The VR operation mode can be selected.

- A mixing curve can be set.
- The curve operation mode can be changed.
 - Single : Displays only the mixing curve
 - Fine Tuning : Displays the adjustment rate of the fine tuning VR
 - All Cond. : Displays the mixing curve of all the conditions (when conditions are set)

Butterfly

[Corresponding model type]: Glider, 2 ailerons or more

This function allows powerful brake operation by simultaneously raising the left and right ailerons and lowering the flaps (camber flap, brake flap).

Butterfly (Crow) produces an extremely efficient landing configuration by accomplishing the following:

1. Slow the aircraft's velocity.
2. Provide washout at the wing tips to reduce the tendency to tip stall.
3. Create more lift toward the center of the wing allowing it to fly at a slower speed

- Mixing during flight can be turned ON/OFF by setting a switch. (Always ON at "ON" setting)
 - The ailerons, flaps, and elevators operation speed can be adjusted. (IN side/OUT side)
 - A delay can be set for each condition. A cut switch which can turn OFF the delay function can also be set.
 - The differential rate can be adjusted.
- *When servo binding occurs when setting the ailerons and flaps in butterfly mixing, use the AFR function to adjust the rudder angle.

- Touch the [Butterfly] button in the Model Menu to call the setup screen shown below.
(The display screen is an example. The actual screen depends on the model type. The screen shown below is for 4 ailerons and 4 flaps.)
- Touch the ACT button and set the function to ACT (ON).
- When setting a switch, touch the SWITCH [ON] button to call the <Switch> screen, and then select the switch and set its ON direction.
- When offsetting the butterfly operation reference point, operate to the point you want to change and then touch the Offset button. The reference point displays 0%. When [Yes] is touched, the reference point is changed. Then, is "initialized elevator curve? " is heard, it chooses in which.

- Group/single mode switching (Gr./Sngl)

- Touch the Mixing Rate AIL and FLP buttons and adjust the mixing rates.

• Return to Model Menu

- Aileron and flap servos speed setting
- Condition delay setting and cut switch setting
- Differential rate adjustment
- To elevator correction setup screen
It is not displayed in a flyingwing.
- Calls the Butterfly AFR (D/R) setup screen

- Touch the ELE correction rate buttons and adjust the rates with the adjustment buttons displayed on the screen.

[(ELE Setup] screen)

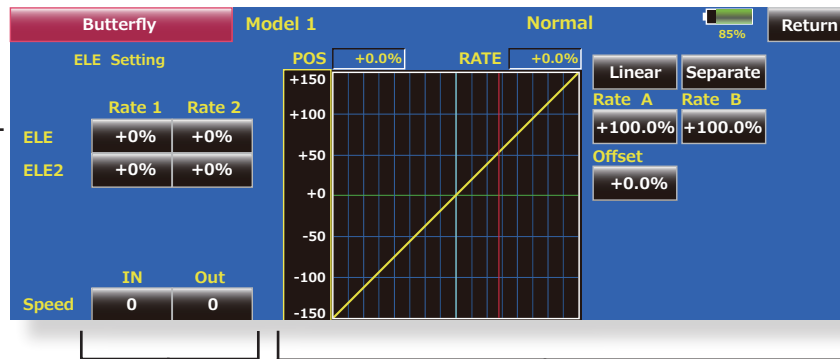

• Servo speed setting

• Mixing curve setting

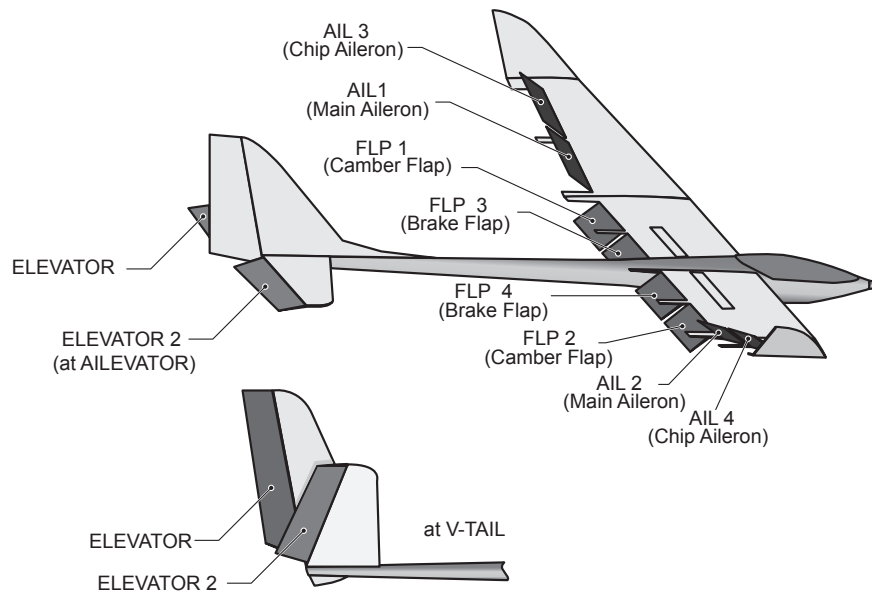

Trim Mix 1/2

[Corresponding model type]: Glider, 2 ailerons or more

The amount of ailerons, elevator, and flaps (camber flap, brake flap) trim offset can be set to a switch.

As an example **Trim Mix 1** can be set up for launching, with speed flaps and ailerons dropped, and a slight amount of up elevator. **Trim mix 2** can be used for high speed flying, with both ailerons and speed flaps reflexed slightly, and a bit of down elevator.

The trim functions can be activated during flight by setting a switch. To prevent sudden trim changes when switching flight conditions, a delay can be set to provide a smooth transition between the two.

Example

1. Touch the ACT button and set the trim mix function to [ON].
*When separating the settings for each condition, touch the group mode button and set it to [Sngl].
 2. Select the ON/OFF switch.
 3. Select the [Manual] or [Auto] mode.
In the [Auto] mode, also select an auto SW. This switch can be linked to a stick, etc.
- <Speed>
In: The operation speed at switch ON can be set.
Out: The return speed at switch OFF can be set.
- <Fine Tuning>
The offset rate can be varied in the Fine Tuning numeric range set at screen [2/2] by VR, etc. selection.
- <Condition Delay>
When flight conditions are set, the operation speed can be set for each condition. Condition delay operation can be interrupted and each rudder quickly returned to its original position by selecting a cut switch.

- Touch the [Trim Mix 1] button in the Model Menu to call the setup screen shown below.

(The display screen is an example. The actual screen depends on the model type. The screen shown below is for 4 ailerons and 4 flaps.)

(Touch the [1/2] button to switch to page 2.)

- Touch the ACT button and set the function to ACT (ON).
- When setting a switch, touch the Switch button to call the <Switch> screen, and then select the switch and set its ON direction. (Always ON at "ON" setting)

• Group/single mode switching (Gr./Sngl)

• Return to Model Menu (Trim mix setup page 1/2)

• Manual/Auto mode selection
Manual: Switches the function ON/OFF by switch
Auto: Trim mix function call can be linked to a stick, etc. A stick switch, etc. separate from the function ON/OFF switch is set.

• Ailerons, flaps, an elevators servo speed setting

• Condition delay setting and cut switch setting.

• When using a fine tuning VR, touch this button to call the <Switch> screen.

- The ailerons, flaps, and elevators offset rate can be adjusted.
Touch the corresponding button and adjust the rate with the adjustment buttons displayed on the screen.

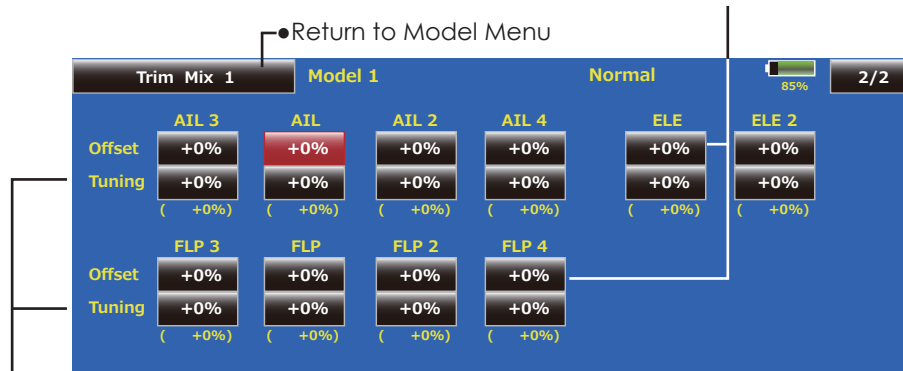

- When a fine tuning VR is set on the next page (1/2), the ailerons and flaps trim rates can be adjusted.
Touch the corresponding button and adjust the rate with the adjustment buttons displayed on the screen.

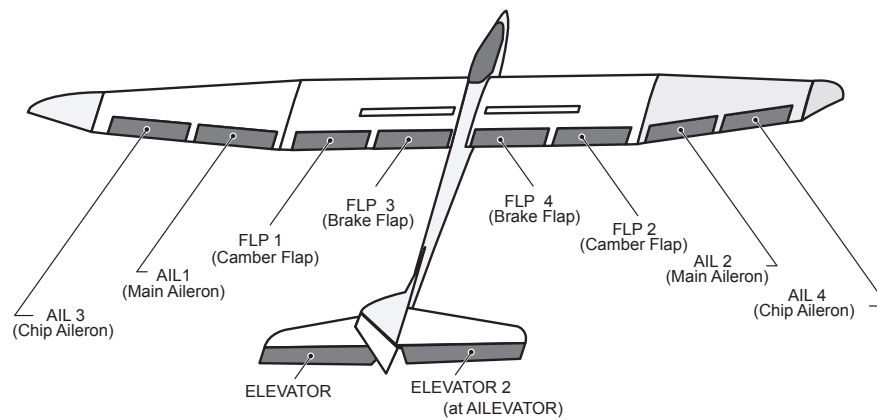

at V-TAIL

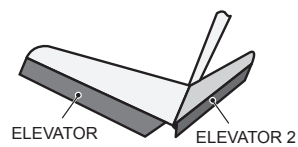

Airbrake

[Corresponding model type]: Airplane, general

This function is used when an air brake is necessary when landing or diving, etc.

The preset elevators and flaps (camber flap, brake flap) offset amount can be activated by a switch.

The offset amount of the aileron, elevator, and flap servos can be adjusted as needed. Also the speed of the aileron, elevator, and flap servos can be adjusted. (IN side/OUT side) A delay can be set for each condition, and a Cut switch which will turn OFF the delay can be chosen. Trim amounts can be fine-tuned by setting a VR You can also set the Auto Mode, which will link Airbrake to a stick, switch, or dial. A separate stick switch or dial can also be set as the ON/OFF switch.

Setting example for F3A and other flaperon specifications

(When 2 ailerons model type selected)
(Page 2/2)

Offset rate:
AIL: [-35~-45%], AIL2: [-35~-45%], ELE: [+5~7%]

Note: The input numerics are examples. Adjust the travel to match the fuselage.

(Page 1/2)

ACT: [ON]
Group: [Sngl]
Switch: [SC-C]
Mode: [Manual]

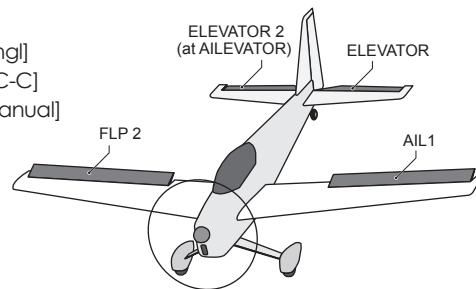

- Touch the [Airbrake] button in the Model Menu to call the setup screen shown below. (The display screen is an example. The actual screen depends on the model type. The screen shown below is for 4 ailerons and 4 flaps.)
- Touch the ACT button and set the function to ACT(ON).
- When setting a switch, touch the Switch button to call the <Switch> screen, and then select the switch and set its ON direction. (Always ON at "ON" setting)

- Group/single mode switching (Gr./Sngl)

- When using a fine tuning VR, touch this button to call the <Switch> screen.

Return to Model Menu (Airbrake setup screen 1/2)

- Ailerons, flaps, an elevators servo speed setting
(For a description of the setting method, see the description at the back of this manual.)

- Condition delay setting (for a description of the setting method, see the description at the back of this manual) and cut switch setting.

- Manual/Auto mode selection
Manual: Switches the function ON/OFF by switch
Auto: Trim mix function call can be linked to a stick, etc. A stick switch, etc. separate from the function ON/OFF switch is set.

- The aileron, flap, and elevator offset rates can be adjusted.
Touch the corresponding button and adjust the rate with the adjustment buttons displayed on the screen.

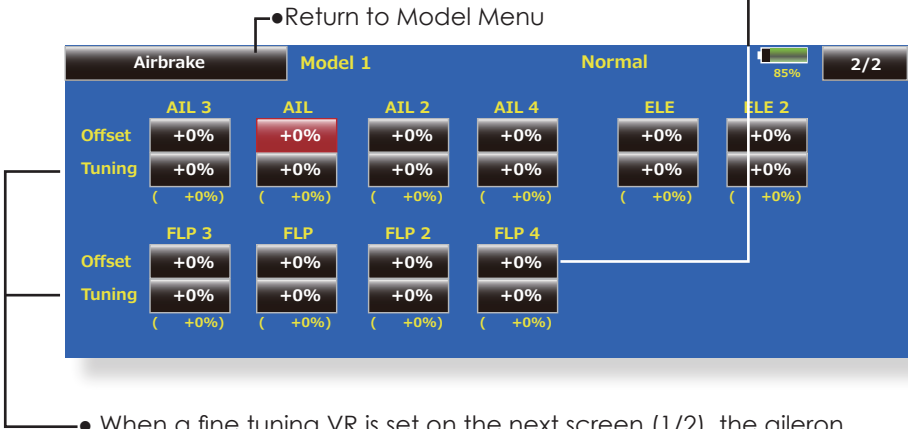

- When a fine tuning VR is set on the next screen (1/2), the aileron and flap trim rates can be adjusted. Touch the corresponding button and adjust the rates with the adjustment buttons displayed on the screen.

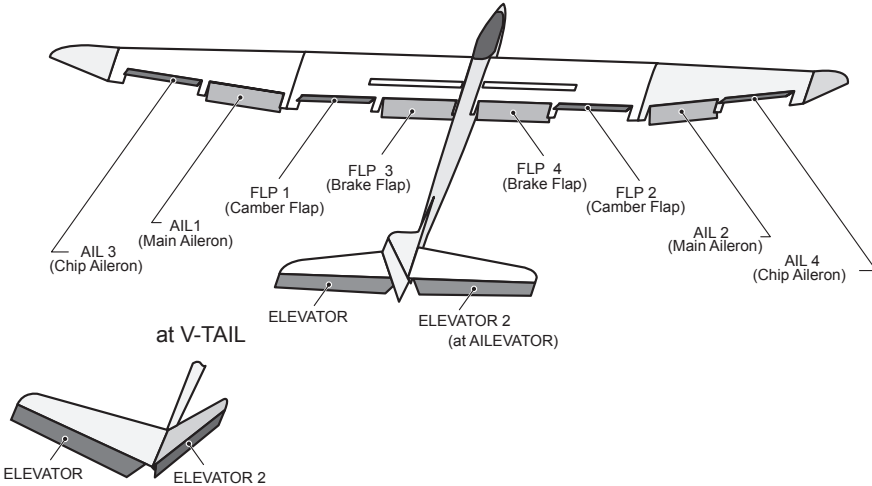

Gyro

[Corresponding model type]: Airplane/glider, general

This function is used when a gyro is used to stabilize the fuselage attitude. The sensitivity and operation mode (Normal mode/GYmode) can be switched with a switch.

- Three rates (Rate 1/Rate 2/Rate 3) can be switched.
- Up to 3 axes (Gyro/Gyro 2/Gyro 3) can be simultaneously controlled.

*Initial setting does not assign a sensitivity channel. Use the

Function menu of the Linkage Menu to assign the sensitivity channel (Gyro/Gyro2/Gyro3) used to a vacant channel beforehand.

Set [ACT] and [Trim] other than Function to [NULL].

- Touch the [Gyro] button in the Model Menu to call the setup screen shown below.
- Group/single mode switching (Gr./Sngl)
(For more information, see the description at the back of this manual.)

Return to Model Menu

	ACT	Type	Switch	Gyro Rate			
				Gyro	Gyro2	Gyro3	
Rate1	INH	GY	OFF	AVCS 0%	AVCS 0%	AVCS 0%	Gr.
Rate2	INH	GY	OFF	AVCS 0%	AVCS 0%	AVCS 0%	Gr.
Rate3	INH	GY	OFF	AVCS 0%	AVCS 0%	AVCS 0%	Gr.

• The operation mode (AVCS/NOR) and sensitivity of the 3 axes Gyro/Gyro2/Gyro3 can be set.

- Three rates (Rate 1/Rate 2/Rate 3) can be used.
- Touch the ACT button of the rate to be used, and set the function to ACT ([ON] or [OFF]).
- When a Futaba gyro is used, when [GY] type is selected, the sensitivity set value is directly read in both the AVCS and NOR modes.
- When setting a switch, touch the switch button to call the <Switch> screen, and then select the switch and set its ON direction.

V-tail

[Corresponding model type]: Airplane/glider, V-tail

This function let's you adjust for left and right rudder angle changes at elevator and rudder operation of a V-tail airplane.

V-tail is when 2 servos are used together to control rudder movement as Elevators. In addition to each rudder side moving up and down together, each side moves in opposite directions when moving as Elevators. On a V-tail, this is also known as a Ruddervator, as they can serve the same purpose.

- Touch the [V-tail] button in the Model Menu to call the setup screen shown below.
- Group/single mode switching (Gr./Sngl)

•Return to Model Menu

(Rudder function)
Left and right travel adjustment at rudder operation

(Elevator function)
Up and down travel adjustment at elevator operation

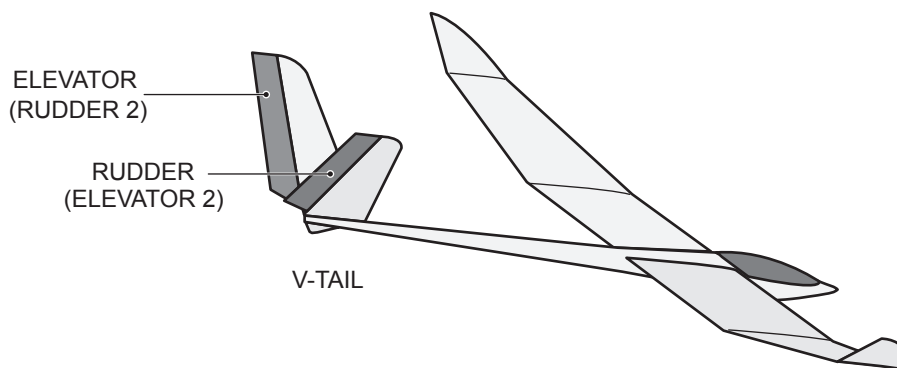

Ailevator

[Corresponding model type]: Airplane/glider, V-Tail
(Effective only when 2 servos used at the elevators)

This function improves the operating performance of the roll axis by operating the elevators as ailerons.

Ailevator is where each elevator in a standard (conventional) or v-tail moves independently, like ailerons on a wing. In addition to each elevator side moving up and down together, each side moves in opposite directions when moving as an Ailevator. On a V-tail, this is also known as a Ruddervator, as they can serve the same purpose. Typically, both Ailevator and ailerons are coupled together to maximize roll performance, especially on larger wingspan planes..

Note: Select Ailevator as the Model Type at the Model Type screen. This changes the output channel. Check the Function menu.

- Touch the [AIL] button in the Model Menu to call the setup screen shown below.
- Group/single mode switching (Gr./Sngl)

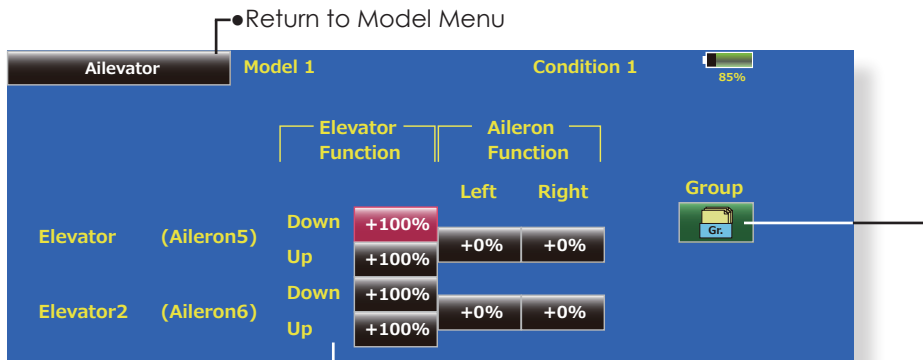

(Aileron function)

- When the elevators are used as ailerons, aileron travel of the left and right elevators can be adjusted.

(Elevator function)

- The up and down rate of the left and right elevators when the elevator stick is manipulated can be individually adjusted.

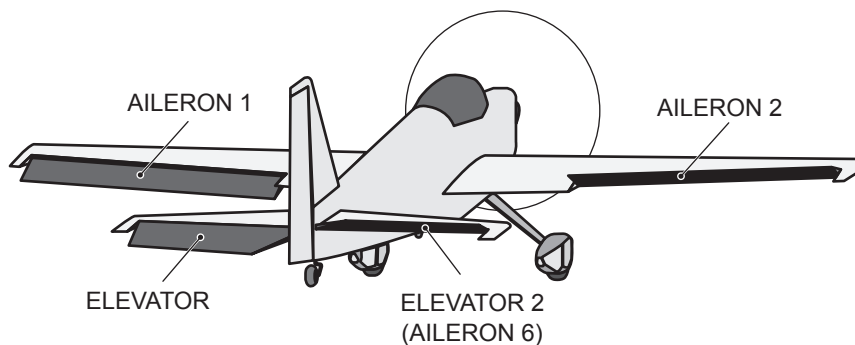

Winglet

[Corresponding model type]: Airplane/glider, winglet

This function adjusts the rubber left and right rudder angle of winglet specifications fuselages.

Winglets are used to improve the efficiency of aircraft lowering the lift-induced drag caused by wingtip vortices. The winglet is a vertical or angled extension at the tips of each wing.

Winglets work by increasing the effective aspect ratio wing without adding greatly to the structural stress and hence necessary weight of its structure - an extension of wing span would also permit lowering of induced drag, though it would cause parasitic drag and would require boosting the strength of the wing and hence its weight - there would come a point at which no overall useful saving would be made. A winglet helps to solve this by effectively increasing the aspect ratio without adding to the span of the wing.

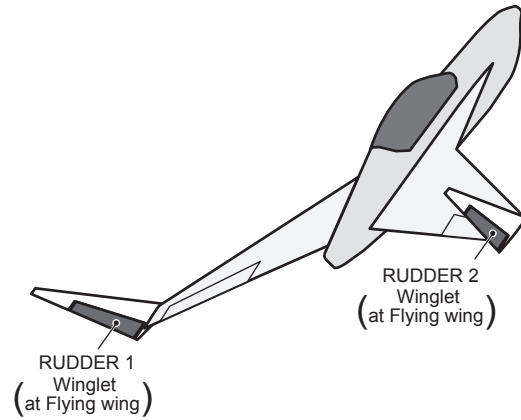

- Touch the [Winglet] button in the Model Menu to call the setup screen shown below.

- Group/single mode switching (Gr./Sngl)

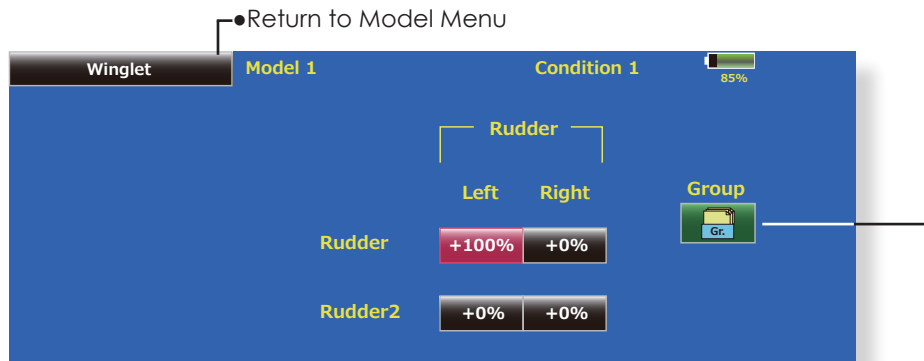

(Rudder 1/2)

- The travel at rudder stick left and right operation can be individually set.

Motor

[Corresponding model type]: EP glider/Airplane, general

This function lets you set the operation speed when the motor of a F5B or other EP glider is started by switch. The operation speed can be set in 2 ranges of slow speed flight and high speed flight (Speed 1/Speed 2). This function can also be operated as a safety function by setting 2 switches.

- The In side and Out side operating speeds can be adjusted independently in 2 ranges (Speed 1/Speed 2).
- The boundary between the 2 ranges can be set. (From Speed 1 to Speed 2)
- The set operation speed operation can be activated at initial operation only. (1 time operation) However, operation can be repeated

by setting the switch to OFF before operation is finished. When you want to reset 1 time operation, set the ACT button to [INH] and then reset it to [ON].

- The motor is controlled by SW-G[Mode1]SW-E[Mode2]. (Initial setting) When changing the switch or stick which controls the motor, first change Function of the Linkage Menu.

Note: When using this function, always check initial operation with the propeller removed.

Note: A warning message appears when this mix is on at the time of power up.

- Touch the [Motor] button in the Model Menu to call the setup screen shown below.

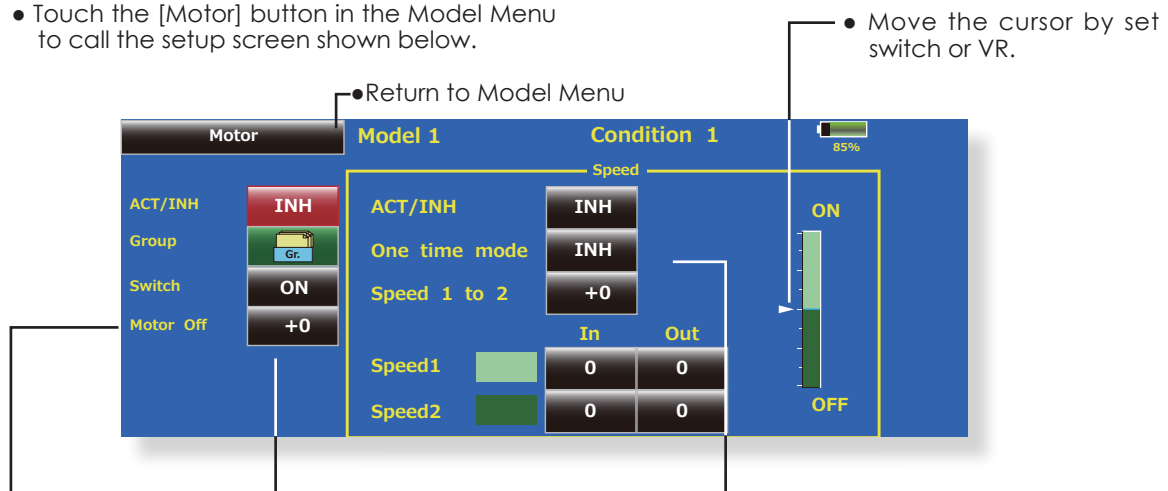

- Operation
Touch the button and set the function to ON.
- Group/single mode switching (Gr./Sngl)
- Switch
A switch that turns the function itself ON/OFF can be selected.
- Motor off
[Yes] and [No] are displayed by touching the Motor Off button when [SW-G(Mode1)] [SW-E(Mode2)](Initial setting)is in the motor OFF position. When [Yes] is touched, the direction of the motor switch is memorized. The screen graph display ON direction also changes.

- Operation
Touch the button and set the function to ON.
- When you want to set the "One time mode", touch the button and set the mode to [ON].
- Speed 1 to 2
The Speed 1 and Speed 2 region boundary can be changed,
- Operation speed adjustment
The speed when Speed 1 and Speed 2 are ON (In) and OFF (Out) can be adjusted.

Notes

- First decide the motor OFF point, and then set the speed. When you want to reset the motor OFF point, also reset the speed.
- We recommend that Motor OFF be set in combination with F/S.
- Set the basic operation direction with the Reverse function to match the amp used.
- Always set the Motor OFF position.

RUD to ELE

[Corresponding model type]: Airplane, general

This function is used when you want to mix elevator operation with rudder operation. It is used to correct undesirable tendencies when rudder is applied in roll maneuvers, knife edge, etc. of stunt planes.

- A mixing curve can be set.
 - Mixing during flight can be turned ON/OFF by setting a switch. (Always ON at "ON" setting)
 - The amount of correction rudder can be memorized by using the Memory function.
 - This is convenient at mixing curve setting. When memory operation (switch operation) is performed with correction rudder applied in the Memory Mode, the stick position at that time is displayed on the mixing curve. The point is automatically reflected in the curve. (When the Memory function is used, "Line" is automatically selected as the curve type.)
 - Link can be set: Links this mixing to other mixings.
 - The mixing rate can be fine-tuned by setting a VR. (Fine tuning)
- Touch the [RUD to ELE] button in the Model Menu to call the setup screen shown below.

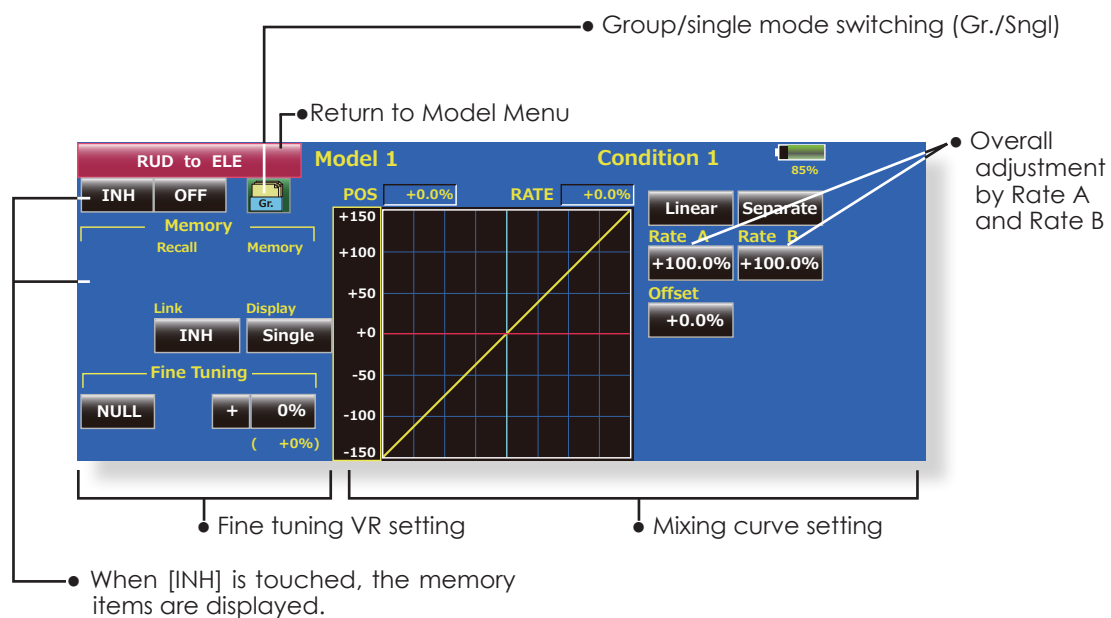

Setting method

- Touch the "INH" button, and set the function to ACT(ON).
- When setting a switch, touch the "ON" button to call the <Switch> screen, and then select the switch and set its ON direction. (Always ON at "ON" setting)
(For a description of the switch setting method, see the description at the back of this manual.)
- When setting a VR, touch the Fine Tuning "NULL" button to call the <Switch> screen, and then select the VR. The fine tuning rate and adjustment direction can be set.
The VR operation mode can also be set.
- The curve display mode can be changed.
Single : Displays the mixing curve only
Fine Tuning : Displays the fine tuning rate of the fine tuning VR
All Cond. : Displays the mixing curve of all the conditions (When conditions are set)
- When setting Link, touch the Link button and set it to ON.

Memory function usage method

(Example) Using the memory function with an F3A airplane (knife edge correction)

*When call switch ⇒[SW-A] and memory switch⇒[SW-H] were set

[Memory function operation]

1. Memory function mode: [Manual]⇒[Memory]
2. When the memory switch (SW-H) is set to ON while performing elevator correction when rudder was applied at knife edge, the point position at that time is memorized. Memorization is performed while changing the left and right stick positions.
3. To recall the memorized positions, set [SW-A] to ON. The memorized correction rate is reflected on the curve, and operation is simultaneously set.

Note: When memorized from manual before flight, be sure that the memory SW is not accidentally set to ON and incorrect mixing setting is not applied when taxiing, starting the engine, etc.

Snap Roll

[Corresponding model type]: Airplane, general

This function selects the switch and rate adjustment of each rudder, (ailerons, elevators, or flaps) when a snap roll is performed.

- Four snap roll directions can be set. (Right/up, right/down, left/up, left/down)
- Operation mode: When [Master] mode is selected, the Snap Roll function is turned ON/OFF by master switch in the state in which the direction switch was switched to the direction in which you want to snap roll. When [Single] mode is selected, snap roll in each direction can be executed by means of independent switches.
- A safety switch can be set. As a safety measure, the switch can be set so that snap roll is not executed when, for instance, the landing gear is lowered, even if the switch is turned on accidentally. The snap roll switch is activated only when the safety switch is ON.
- The operation speed of the aileron, elevator, and flap servos can be adjusted for each snap roll direction. (In side/Out side) (Page 2/2)

(Example) Setting example for F3A

- Mode: [Master]
- Safety SW: [SW-G] (Safety measure)
- Master SW: [SW-H] (Main switch for executing snap roll)
- Direction switches:
 - *The snap roll up side left and right and down side left and right direction switches are selected here.
 - Right/Up: OFF [SW-D] Right/Down: OFF [SW-D] Left/Up: OFF [SW-A]
 - Left/Down: OFF [SW-A]
- Speed adjustment (Screen 2/2)

The operation speed of each control surface when the snap switch is ON can be changed and snap roll executed by stick while there is switch operation can be performed.

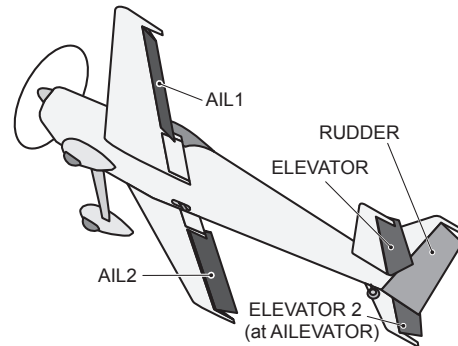

- Curve display mode switching (Single/Fine tuning/All Cond.)
- Group/single mode switching (Gr./Sngl) (For more information, see the description at the back of this manual.)

Return to Model Menu

Direction switches

Rate adjustment of each rudder

Snap Roll		Model 1	Condition 1	85%	1/2	
Mode	Master					
Master SW	OFF	Safety SW	ON	Group	Gr.	
		ACT	Switch	Rate		
				AIL	ELE	RUD
Right / UP	OFF	OFF	OFF	+100%	+100%	+100%
Right / Down	OFF	OFF	OFF	+100%	-100%	-100%
Left / UP	OFF	OFF	OFF	-100%	+100%	-100%
Left / Down	OFF	OFF	OFF	-100%	-100%	+100%

- Direction switches
- Rate adjustment of each rudder

Adjustment of the servo speed of each rudder

Snap Roll		Model 1	Condition 1	85%	2/2		
Speed							
		AIL		ELE		RUD	
		IN	Out	IN	Out	IN	Out
Right / UP		0	0	0	0	0	0
Right / Down		0	0	0	0	0	0
Left / UP		0	0	0	0	0	0
Left / Down		0	0	0	0	0	0

- Adjustment of the servo speed of each rudder

Multi Engine

[Corresponding model type]: Airplane, general

This function lets you adjust the throttle when using a multi engine airplane with up to 4 engines. The Throttle Cut function, Idle Down function, Throttle Hold function, High Trim, and Idle Trim can be adjusted by throttle channel (THR, THR2, THR3, THR4).

*Initial setting assigns only one throttle channel (THR).
When using this function, the number of throttle channels must be assigned beforehand at the Function menu of the Linkage Menu.

- The throttle cut position can be set for each throttle channel. Throttle cut operation is linked to the switch set with the Throttle Cut function of the Linkage Menu.

*The throttle cut position set at this screen is effective.

- The throttle down offset rate can be set for each throttle channel. Idle down operation is linked to the switch set with the Idle Down function of the Linkage Menu.

*The idle down offset rate set at this screen is effective.

- Operation can be fixed at the engine speed (carburetor opening angle) for each throttle channel with the Hold Position function. The hold position can be changed.
- High side trim and idle trim can be set for each channel. Operation acts as high trim or idle trim based on the center.

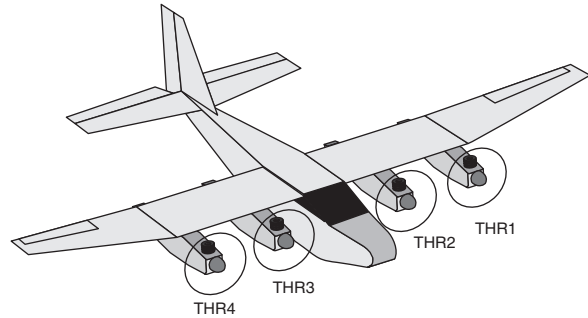

- Touch the [Multi Engine] button in the Model Menu to call the setup screen shown below.

*The number of engines (1~4) assigned by Function menu in the Linkage Menu setup screen is displayed.

Return to Model Menu

Multi Engine		Model 1				Condition 1				85%	1/2
		THR	THR2	THR3	THR4						
ACT / INH		INH	INH	INH	INH						
Throttle Cut	ACT	INH	INH	INH	INH						
	Posi.	17%	17%	17%	17%						
Idle Down	ACT	INH	INH	INH	INH						
	Rate	17%	17%	17%	17%					Hold Pos.	
Throttle Hold		INH	INH	INH	INH					17%	

- Throttle cut position setting (for each engine)
- Idle down offset rate setting (for each engine)
- Throttle hold position setting

Multi Engine		Model 1				Condition 1				85%	2/2
		THR	THR2	THR3	THR4						
High Trim	Control	INH	INH	INH	INH						
	Rate	+ 0%	+ 0%	+ 0%	+ 0%						
		(+0%)	(+0%)	(+0%)	(+0%)						
Idle Trim	Control	INH	INH	INH	INH						
	Rate	+ 0%	+ 0%	+ 0%	+ 0%						
		(+0%)	(+0%)	(+0%)	(+0%)						

- High Trim setting (for each engine)
- Idle Trim setting (for each engine)

Accelerration

[Corresponding model type]: EP glider, glider

Acceleration setting can be performed at elevator, ELE to Camber and AIL to RUD.(Glider and EP glider only)

- This setting is divided into elevator setting and camber setting. The setting method is the same.
- Camber setting sets the acceleration function for ELE to Camber mixing. Setting is not performed when ELE to Camber mixing is INH.
- The acceleration function can be set for both the Up side and Down side.

- Function ON/OFF switch setting is performed for AIL to RUD setting only.
- AIL to RUD setting is acceleration function setting for AIL to RUD mixing. It is not performed when AIL to RUD mixing is INH.

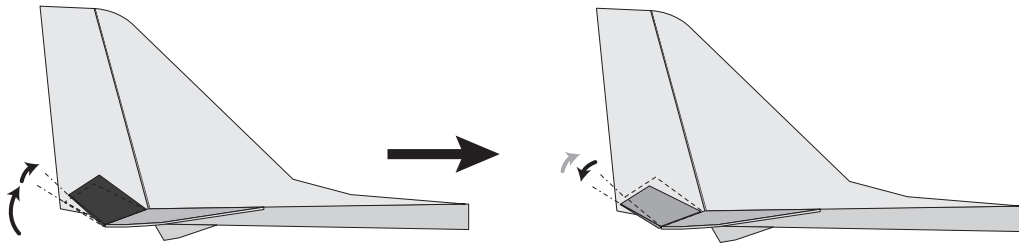

• Return to Model Menu

Acceleration		Model1	Condition 1	100%	1/2
Elevator					
ACT/INH	INH		+100%		
Rate	Up 0%	Down 0%	D	[Slider]	
Dumping	0%		U	[Slider]	
Active Pos	-50%	+50%	-100%		
ELE to Camber					
ACT/INH	INH		+100%		
Rate	Up 0%	Down 0%	D	[Slider]	
Dumping	0%		U	[Slider]	
Active Pos	-50%	+50%	-100%		

• Elevator Acceleration • ELE to Camber Acceleration

• Return to Model Menu

Acceleration		Model1	Condition 1	100%	2/2
AIL to RUD					
ACT/INH	INH		-100%		
Switch	ON		L	[Slider]	
Rate	Left 0%	Right 0%	R	[Slider]	
Dumping	0%				
Active Pos	-50%	+50%	+100%		

• AIL to RUD Acceleration

MODEL MENU (HELICOPTER)

This section contains information on the commands that apply to helicopters only. For instructions on Airplanes and Sailplanes, refer to the sections pertaining to those aircraft. Each of these functions can be set independently for different flight conditions. To get to these settings, touch the desired function button to be entered.

Use the Model Type function in the Linkage Menu to select the swash type matched to the

fuselage beforehand. If you later change model types, all settings will be lost.

Also, add flight conditions at the Condition Select screen before setting the model data at each function. (Up to 8 conditions can be used)

The AFR function, fuel mixture and other functions common to all model types, are described in a separate section.

- Touch the Model Menu button of the Home screen to call the menu shown below. Touch the button of the function you want to set to call the setup screen.

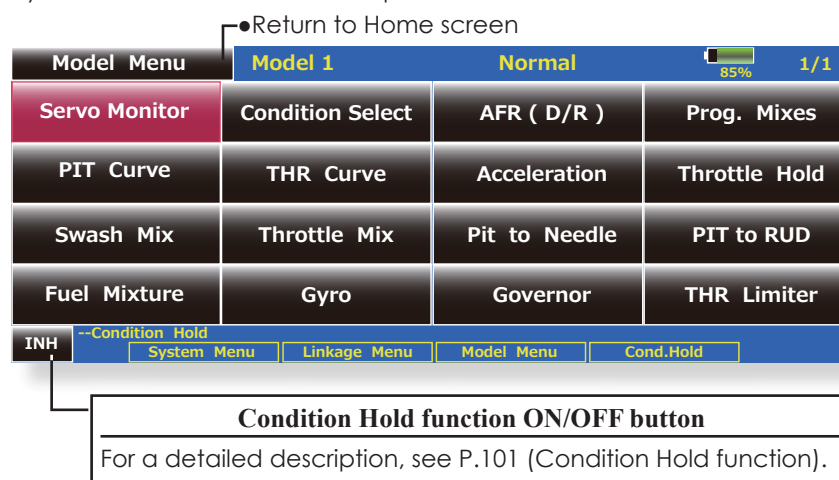

Model Menu functions (helicopter) list

PIT Curve: Adjusts response in different flight conditions

THR Curve: Throttle curve and hovering trim adjustment

Acceleration: Counteracts torque due to sudden throttle and pitch commands

Throttle Hold: Moves the throttle to idle during autorotation

Swash Mix: Compensates for each control response

Throttle Mix: Compensates for power loss when cyclic applied

Pit to Needle: Adjusts response curve in different flight conditions

Pit to RUD: Handles torque changes from pitch angle inputs

Fuel Mixture: Commands a second servo to adjust the fuel mixture at the carburetor

Gyro: Used to switch Futaba GY series gyro sensitivity

Governor: Used to switch RPM of the helicopter's head

Throttle Limiter: Limits the high range of the throttle movement by any slider or trimmer

PIT Curve/Pitch Trim

PIT Curve

This function adjusts the pitch operation curve for each flight condition for the optimal flight response relative to movement of the throttle stick.

The pitch curve can be freely selected from linear operation curve to smooth curve, and adjusted to match the curve you want by means of the T18MZ's powerful Curve Edit Function (6 types of curves can be selected). Up to 17 points can be set for linear or curve types. However, when using

the 3 points or 5 points specified to create a curve, a simple and smooth curve can be created by selecting the curve type and reducing the number of input points to 3 or 5, and then entering the specified value at the corresponding points that you created. a curve, a simple and smooth curve can be created by selecting the curve type and reducing the number of input points to 3 or 5, and then entering the specified value at the corresponding points that you created.

- Touch the [PIT Curve] button in the Model Menu to call the setup screen shown below.
- There are 4 types of display. The curve of all the conditions or the pitch and throttle curves can be displayed on one screen.

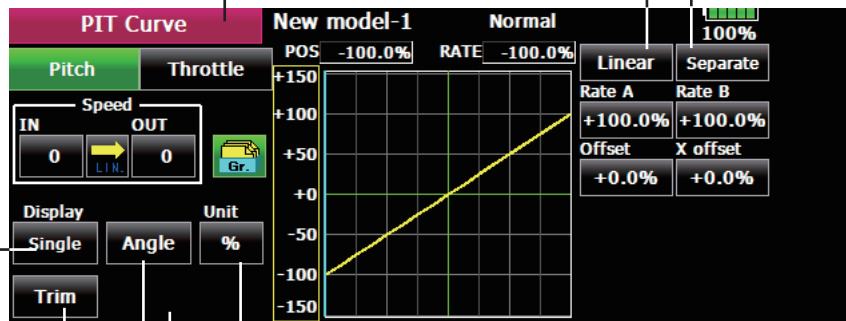

- Linear type is 9 points, but for simple use, 4~5 points are sufficient.
- Normally use Separate.

- Trim can be used as hovering pitch and pitch trim. The high and low side pitch can be fine-tuned.
- Units can be selected from [%] and [Deg]. When [Deg] is selected, the rotor pitch angle is displayed and becomes the setting standard. When [Deg] was selected, the high, center, and low pitch angles are entered.
- Can be copied to the pitch trim adjustment position.
- When the [Angle] button is touched, the pitch angle input screen is displayed. Input the maximum pitch, center, and low pitch.

Normal curve adjustment

- For normal curve, usually use [Line] type and create a basic pitch curve centered about hovering. Use this function together with the THR Curve (Normal) function and adjust the curve so that up/down control is best at a constant engine speed.

Idle up curve adjustment

- For the high side pitch curve, set the maximum pitch which does not apply a load to the engine. For the low side pitch curve, create curves matched to loop, roll, 3D, and other purposes and use the idle up curves according to the performance.

Note: If you chance the curve type, all data will be reset.

Throttle hold curve adjustment

- The throttle hold curve is used when executing auto rotation dives.

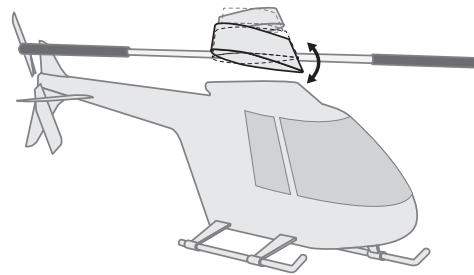

Operation precautions

! WARNING

- When actually starting the engine and flying, always set the idle up condition switch to [OFF] and start the engine in the idling state.

Setting method

- Group button: When you also want to enter the data to all other conditions, enter the data in the group mode (GRP). When doing so, the same settings are input to all the other conditions. When you want to set data into each condition independently, select the single (SNGL) mode.
- Normal % input or angle input can be selected at rate adjustment at curve setting. For angle input, if the high side, low side, and center angles are input beforehand, the rate can be set by reading the angle directly (standard).
- The curve graph display mode can be selected. This is convenient when checking curves other than the curve currently being set.
[Sngl]: Displays only the curve currently being set
[Fine Tuning]: When pitch trim is used, a curve with pitch trim adjustment added is also displayed.

- [All Cond.]: Displays the pitch curve of all the conditions. The curve of the condition currently in use is indicated by a bold line.
- [PIT&THR]: The throttle hold curve of the condition currently in use is also displayed.
- The Throttle Curve setup screen can be called with one touch, which is convenient when making adjustments alternately with the throttle curve.
- The servo operation speed can be set. When adjusted when the pitch is too sensitive, the pitch operation feeling can be changed.
- When increasing the number of points on your curve, use the cursor keys [<][>] and move the cursor to the spot where you want to enter a new curve point (■), then touch the Rate button. A new point is created.

Curve setting examples

The screens shown below are curves created by entering the pitch angle at low, center, and high side 3 points or 5 points at each condition. They were created by reducing the number of points to the 3 points of low side, center, and high side. When actually creating a curve, input the angle specified

at the fuselage (or the reference value).

*For a description of the curve setting method, see the description at the back of this manual.

•Pitch Curve (Example)

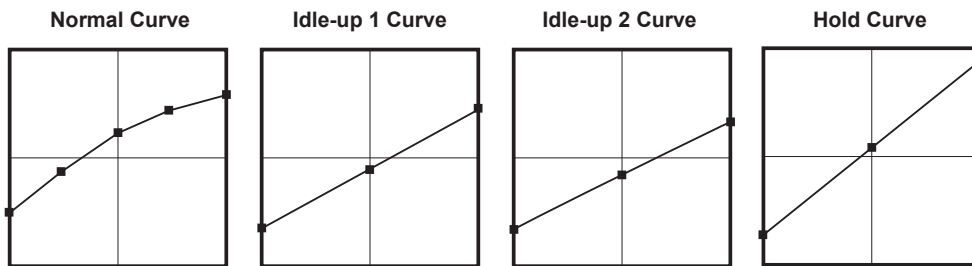

Pitch Trim (Hovering pitch, high pitch, low pitch)

The hovering pitch, low pitch, and high pitch trim setup screen can be called from the PIT Curve setup screen.

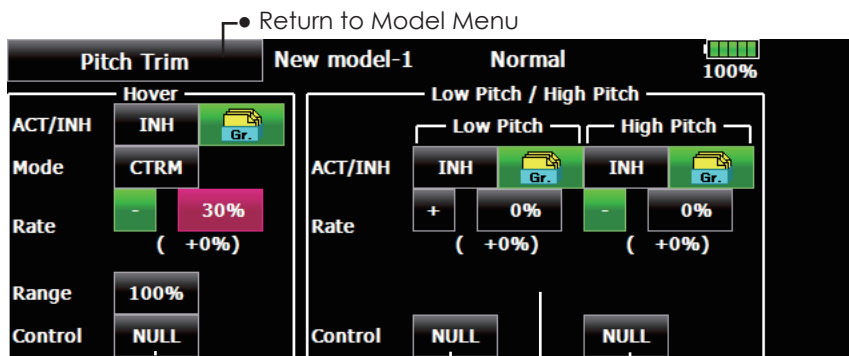

• Hovering pitch trim setting

• Low/High pitch trim

• Adjusts the adjusting dial.

(Continued on next page)

Hovering pitch trim

The Hovering Pitch function trims the pitch near the hovering point. Normally, it is used with the hovering condition. The hovering pitch can be fine tuned for changes in rotor speed accompanying changes in temperature, humidity, and other flight conditions. Adjust the hovering pitch so that rotor speed is constant. This function can be used together with the Hovering Throttle Trim function for more delicate operation.

Setting method

- When using only the hovering (normal) condition, switch the group button to the single mode before setting.
- Set the function to ACT [ON].
- Select the adjustment knob. Selection example: LD or T6
- The trim operation mode (Mode: CTRM/NORM) can be selected.

CTRM mode: Maximum change near center by center trim operation (Does not change at end of the stick movement)

NORM mode: Normal trim (linear) operation. The advantage of using this mode is that the hovering pitch can be adjusted without changing the curve.

- Trim adjustment range (Range) setting
When this value is made small, trim can only be used near the center.
- The trim rate can be adjusted and the operation direction can be changed.

High Pitch/Low Pitch Trim

High Pitch/Low Pitch Trim is the pitch servo high side and low side trim function.

Setting method

- When setting the adjustment knobs common to all the conditions, set them in the group mode.
- Set the function to ACT (ON).
- Select the adjustment knobs. Selection example: LST (high side), RST (low side)
- The trim rate can be adjusted and the operation direction can be changed.
- Trim acts as high side or low side trim with the center as the standard.

THR Curve/Throttle Hover trim

THR Curve

This function adjusts the throttle operation curve for each condition for optimum the engine speed to throttle stick movement.

A throttle curve from linear operation to smooth curve can be set. Adjustment to the curve you want to use is possible by using the 18MZ's powerful Curve Edit Function. Up to 17 curve points can be set, however, when the 5 points and other point data is used, a smooth curve can be easily created by

reducing the number of points of to 5 and entering the specified value at the corresponding points.

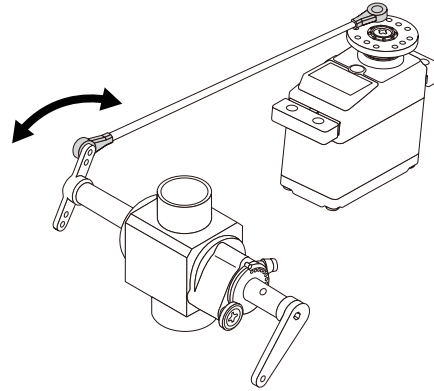

- Touch the [THR Curve] button in the Model Menu to call the setup screen shown below.

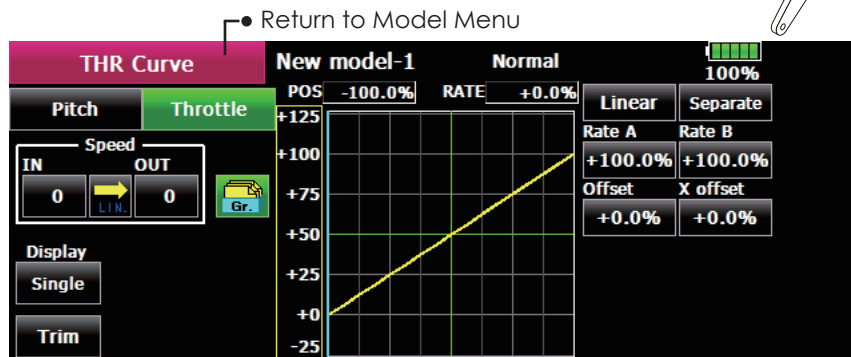

Normal curve adjustment

- Normal curve creates a basic curve centered around hovering. Use it along with the normal pitch curve and adjust so that up/down control at a constant engine speed is easiest.

Idle up curve adjustment

- Set a normal up curve that maintains a constant speed at all times, even when operation which reduces the pitch was performed in flight. Create a curve matched to loop, roll, 3D, or other purposes and the idle up curve according to the performance.

Setting method

- Group button: When you also want to enter the data to all other conditions, enter the data in the group mode (GRP). When doing so, the same settings are input to all the other conditions. When you want to set data into each condition independently, select the single (SNGL) mode.
- The curve graph display mode can be selected. This is convenient when checking curves other than the one being set.
[Sngl]: Displays only the curve being set.
[Fine Tuning]: When Throttle Hover trim is used, a curve with trim adjustment added is also displayed.

Operation precautions

⚠ WARNING

- When actually starting the engine and flying, always set the idle up condition switch to [OFF] and start the engine in the idling mode.

[All Cond.]: Displays the throttle curve of all the conditions. The curve of the condition currently in use is indicated by a bold line.

[PIT&THR]: The pitch curve of the condition currently in use is also displayed.

- The pitch curve setup screen can be called with one touch. This is convenient when alternately adjusting these curves with the pitch curve.
- The servo speed can be set. Adjust the throttle speed when the throttle is too sensitive

Curve setting examples

The curves shown below were created by using the Line mode and inputting the data of the 5 points 0% (low side), 25%, 50% (center), 75%, 100% (high) side at each condition. They were created by reducing the number points of the line to 5. When

actually creating a curve, enter the data specified per the fuselage (or the reference value).

• Throttle Curve (Example)

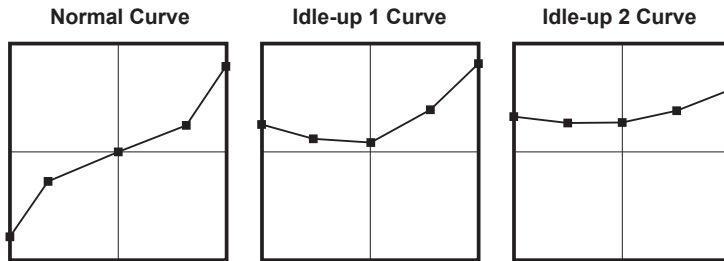

Throttle Hover trim

The Throttle Hover trim setup screen can be called from the THR Curve setup screen.

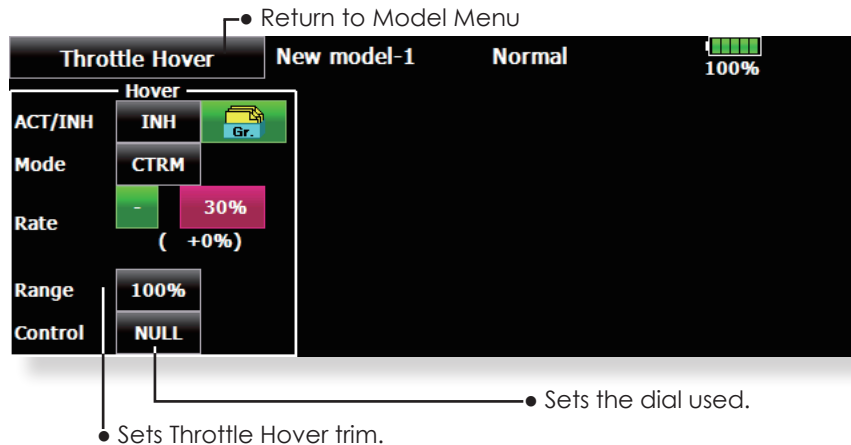

The Throttle Hover function trims the throttle near the hovering point. Normally, use it with hovering conditions. Changes in rotor speed accompanying changes in the temperature, humidity, and other flight conditions can be trimmed. Adjust the throttle so that rotor rotation is most stable. More delicate trimming is also possible by using this function along with the Hover Pitch function.

Setting method

- When using the hovering (normal) condition only, switch the [Gr.](group button) mode to the [Sngl](single) mode and make the settings.
- Set the function to ACT ([ON]).
- Select the adjustment knob. Selection example: RD
- The trim operation mode (Mode: CTRM/NORM)

can be selected.

CTRM mode: Maximum change near center by center trim operation (Does not change at end of the stick movement)

NORM mode: Normal trim (linear) operation The advantage of using this mode is that hovering throttle can be adjusted without changing the curve.

- Trim adjustment range (Range) setting When the value is made small, trim acts only near the center.
- The trim rate can be adjusted and the operation direction can be set.

Acceleration Mixing

An acceleration function can be set. This is used to adjust the pitch and throttle settings when the mixture is either too rich or too lean, which can be caused by sudden operation of the throttle stick.

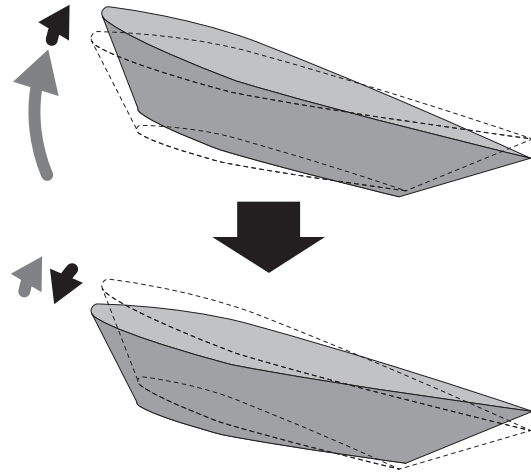

- Touch the [Acceleration] button in the Model Menu to call the setup screen shown below.

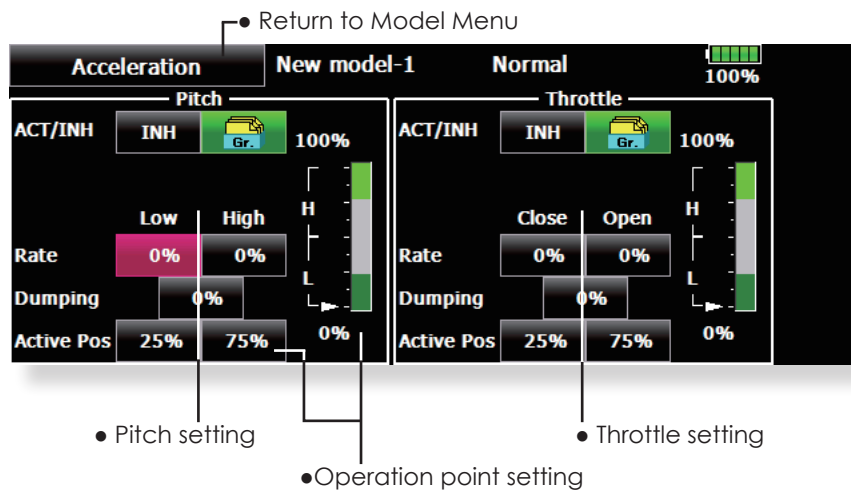

Setting method

- Acceleration can be set at both setting at acceleration (high) and setting at deceleration (low).
(The operation point is displayed on a graph.)
- Acceleration rate setting (Rate)
- The return time after operation (Dumping) can be set.
- The operation point at acceleration and deceleration can be set. When an operation point is exceeded, acceleration is performed.

Note: When using the Acceleration function, since the pitch stroke is large, make your settings so there is no binding of your linkage.

Throttle Hold

This function sets the throttle cut position during an auto rotation dive. The throttle position can also be set to an idling position separate from the throttle cut position. Setting of these 2 positions can be selected by switch. This allows use for switching during training.

Example of use

- Since Throttle Hold has 2 modes (Cut) and (Idle), it is convenient to use it in the Idle mode during training and in the Cut mode when stopping the engine.

Note: When throttle hold is set to ON in the normal condition, throttle hold acts and the throttle servo is deactivated. Always set throttle hold to ON in the hold condition.

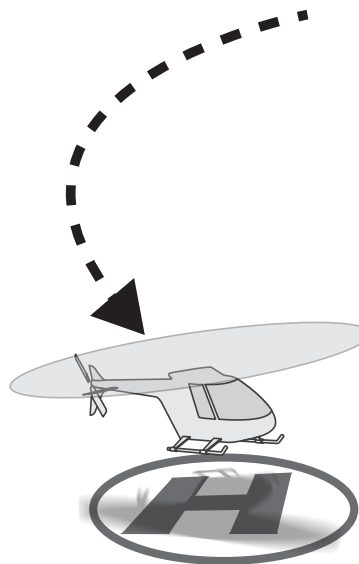

- Touch the [Throttle Hold] button in the Model Menu to call the setup screen shown below.

• Return to Model Menu

• Select the SW to be used.

• Set to the idling position.

• Set to the engine stop position.

Setting method

- Operation mode selection
 - Manual mode:** The throttle hold function is operated by switch operation only.
 - Auto mode:** The throttle hold function operation is linked to the throttle stick position.
 - Auto position setting:** When the Auto mode was selected, the throttle position (auto position) can be selected. Move the throttle stick to the position you want to set and touch the (auto position) button.
- Hold position adjustment
 - Throttle Hold (Cut)** sets the throttle cut position. Adjust it so that the carburetor is full open.
 - Throttle Hold (Idle):** Make this adjustment to maintain idling for training. Adjustments can be made based on the throttle curve idle position.
- The throttle servo operating speed can be adjusted. (Speed)
- The Hold switch can be used to change between the Throttle cut or Training function.

Operation precautions

⚠ WARNING

- When starting the engine, confirm that the idle up condition and throttle hold condition are [OFF].

Swash Mixing

The swash mix function is used to correct the swash plate in the aileron (roll) direction and elevator (cyclic pitch) corresponding to each operation of each condition.

Adjustment by independent curve for aileron, elevator, and pitch operations is possible. The operation can be smoothly adjusted by calling up the “Curve setup” screen by touching the button that corresponds to the mixing and direction which needs correction.

Example of use

- As an example, use swash mixing to correct undesirable tendencies in the roll direction
- For a condition which uses AIL to ELE, set this function to ON. When raising the nose at a right roll, when the Rate B side is input and the right aileron is operated, the elevator moves to the down side. Tune by adjusting the Rate. For right roll, adjust to the Rate A side.

- Touch the [Swash Mix] button in the Model Menu to call the setup screen shown below.

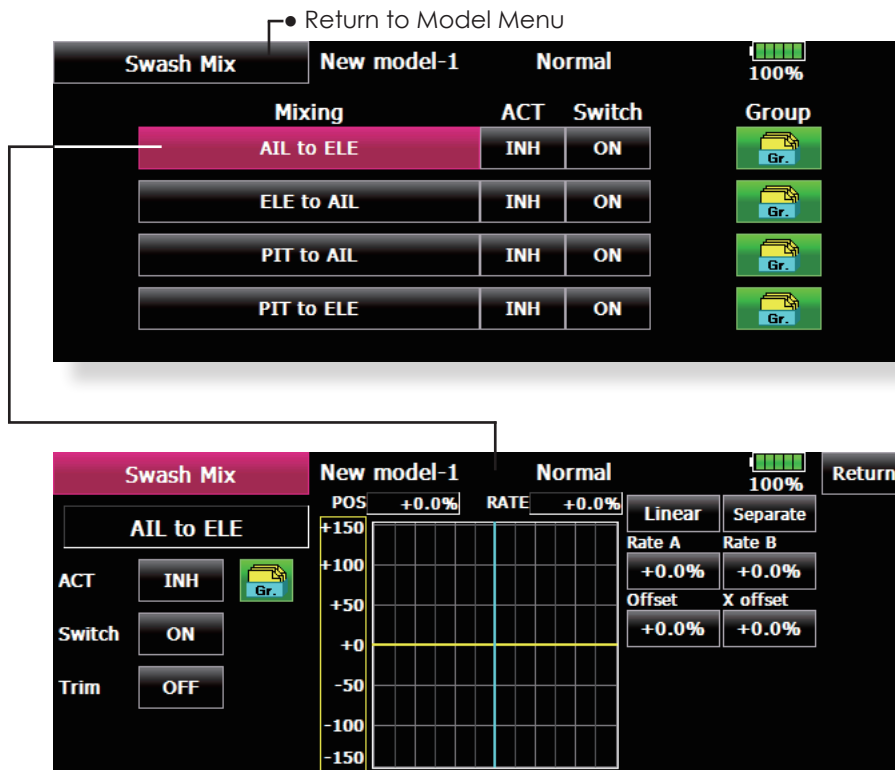

Setting method

- When using this function, touch the [INH] button and display [ON] or [OFF].
- When you want to set the same settings to other conditions, select the group mode (Gr.). When you want to add settings to the selected condition only, select the single mode (Sngl).
- The correction rate can be set by curve.
- A switch can be set.
When [ON] is set, the swash mixing function is operated by merely selecting the condition.

When setting an [ON]/[OFF] switch, touch the [ON] button and set the switch and its ON position at the <Switch> screen.

- Trim on /off setting
You can select mixing characteristics either with trim or without trim.

Throttle Mixing

This function corrects slowing of the engine speed caused by swash plate operation during aileron or elevator operation. The method of applying clockwise or counterclockwise torque when pirouetting can also be corrected.

An acceleration function which temporarily increases the throttle side correction rate relative to rapid stick operation can also be set.

When correction is necessary, touch the mixing corresponding to the mixing that needs correction to call the curve setup screen, and then correct the slowing.

- Touch the [Throttle Mix] button in the Model Menu to call the setup screen shown below.

- CTRM mode: The mixing rate is reduced by the throttle stick high and low position.
- LINEAR mode: Constant mixing rate to all the throttle stick ranges.

Setting example

- AIL to THR applies a load to the engine and corrects sinking of the engine speed when the throttle stick was operated. Engine racing can be adjusted independently at the right aileron and left aileron by Rates A and B.

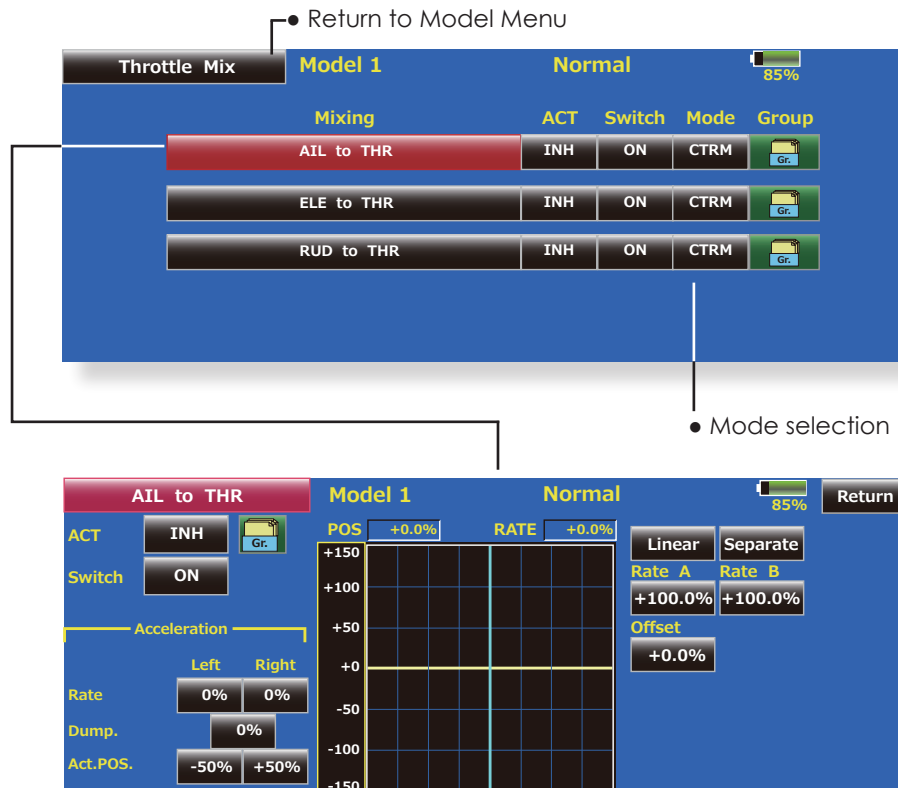

Setting method

- When using this function, touch the [INH] button and display [ON] or [OFF].
- When you want to set the same settings to other conditions, select the group mode (Gr.). When you want to add settings to the selected condition only, select the single mode (Sngl).
- The correction rate can be set by curve.
- A switch can be set.
When [ON] is set, the function is operated by merely selecting the condition.
When setting an [ON]/[OFF] switch, touch the [ON] button and then set the switch and its ON direction at the <Switch> screen.

<Acceleration function setting>

- Acceleration can be set for both settings (High) and (Low) at maximum correction rate.
- Acceleration rate setting (Rate)
- The return time (Dump.) after operation can be set.
- The operation point when the correction rate is increased and decreased can be set independently. When an operation point is exceeded, acceleration operation is performed.

PIT to Needle Mixing

This mixing is used when the engine is equipped with needle control or other fuel-air mixture adjustment. A needle curve can be set.

The Acceleration function which can temporarily increase needle operation during throttle acceleration/deceleration operation can be set. The rise characteristic of the needle servo during acceleration and deceleration operation can be adjusted.

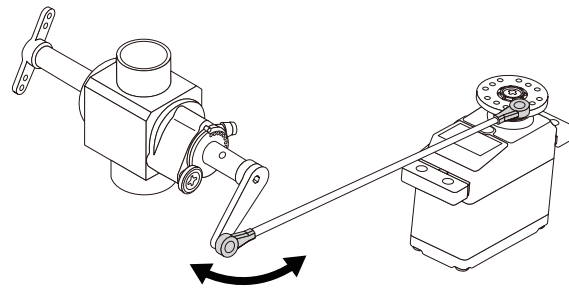

- Touch the [PIT to Needle] button in the Model Menu to call the setup screen shown below.

Setting method

- When using this function, touch the [INH] button and display [ON] or [OFF].
- When you want to set the same settings to other conditions, select the group mode (Gr.). When you want to add settings to the selected condition only, select the single mode (Sngl).
- A needle curve can be set.
- A switch can be set.
When [ON] is set, the function is operated by merely selecting the condition.
When setting and [ON]/[OFF] switch, touch the [ON] button and set the switch and its ON direction at the <Switch> screen.

< Acceleration function setting >

- Acceleration can be set at both setting at acceleration (High) and setting at deceleration (Low).
- The acceleration rate (Rate) and the return time after operation (Dump.) can be set.
- An operation point (Operation Point) at acceleration and deceleration can be set. When an operation point was exceeded, acceleration operation is performed.

PIT to RUD Mixing (Revolution Mixing)

Use this mixing when you want to suppress the reaction torque generated by main rotor pitch and speed changes at pitch operation. Adjust so that the nose does not move in the rudder direction.

An acceleration function which temporarily increases the correction rate at throttle stick acceleration/deceleration operation can be set. The mixing rate at acceleration/deceleration can be set.

However, when a GY Series or other heading hold gyro is used, since correction is performed by

- Touch the [PIT to RUD] button in the Model Menu to call the setup screen shown below.

the gyro, this mixing is not used. **If this function is used when the gyro operation mode is the AVCS mode, the neutral position will change.**

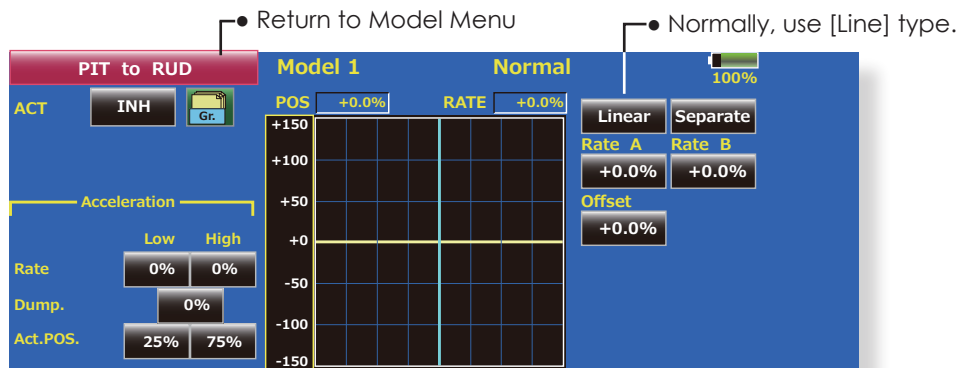
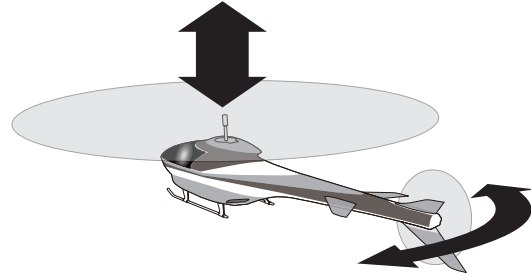

Setting method

- When using this function, touch the [INH] button and display [ON] or [OFF].
- When you want to set the same settings to other conditions, select the group mode (Gr.). When you want to add settings to the selected condition only, select the single mode (Sngl)
- A mixing curve is set.

<Normal condition mixing curve>

The mixing curve rate starts from a small value.

For a rotor with a clockwise operation direction (polarity), when pitch was operated at the plus side, set so that mixing is in the clockwise direction. First, trim at hovering and then adjust the neutral position.

1. Adjustment between slow and hovering
Repeatedly hover from take off and land from hovering at a constant rate matched to your own rhythm, and adjust the pitch so the nose does not deflect when the throttle is raised and lowered.
2. Throttle high side (up to climbing from hovering and diving hovering)
*Repeat climbing and diving from hovering at a constant rate matched to your own rhythm and adjust the pitch so that the nose does not deflect when the throttle is raised and lowered.

<Idle up condition mixing curve>

Set the mixing rate so that the rudder direction at high-speed flight is straight ahead. Adjust for each condition used.

<Acceleration function setting>

- An acceleration function can be set. This is used when the mixture is either too rich or too lean, which can be caused by sudden operation of the throttle stick.
- Acceleration rate setting (Rate)
- The return time after operation (Dump) can be set for both settings (Acceleration (High) and (Deceleration (Low)).
- An Operation Point during acceleration and deceleration can be set independently. When this point is exceeded, acceleration operation is performed.

Gyro Mixing

It is mixing only for a Gyro in the case of using a Futaba GY series Gyro.

Sensitivity and operational mode (Normal mode/GY mode) can be set up for three Gyros for each condition, respectively.

Note: Always set both (ACT) and (Trim) for the [Gyro] function.

Setting example

- Normally, it is convenient to preset high sensitivity (Rate 1) and low sensitivity (Rate 2) when either the AVCS mode or Normal mode is used.

- Touch the [Gyro] button in the Model Menu to call the setup screen shown below.
- A setup of the mode of 3 Gyros and Rete can be performed on this screen.

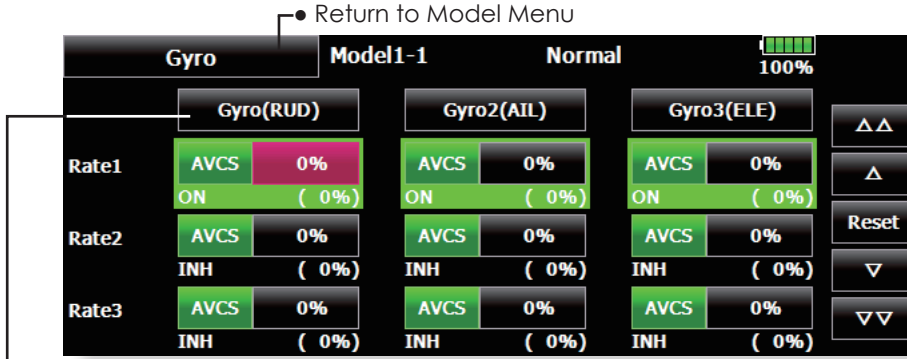

- A detailed setup of each Gyro can be performed on this screen.

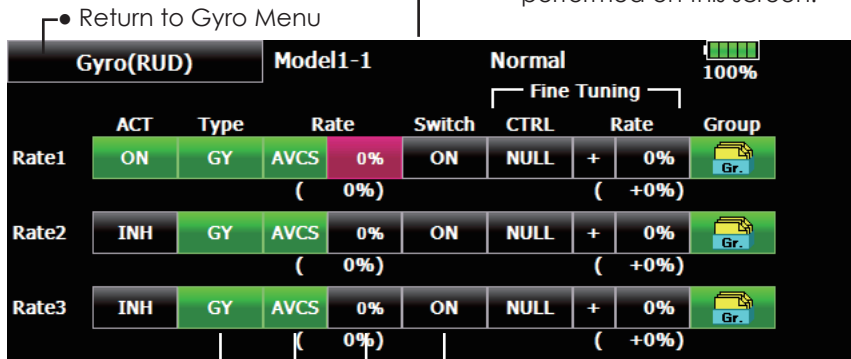

- Selects the selector switch.
- Adjusts the gyro sensitivity by rate.
- Selects [AVCS] or [Nor].
- Select the type of gyro used.

Setting method

- Touch the [INH] button of the rate to be used and display [ON].
- When you want to set the same settings to other conditions, select the group mode (Gr.). When you want to add settings to the selected condition only, select the single mode (Sngl).
- Three rates can be switched for each condition. (Rate 1/Rate 2/Rate 3)
- A fine tuning VR can be set.

Governor Mixing

This is used to switch the RPM of the helicopters head. Up to 3 rates can be set for each condition.

*The governor is used by connecting the governor speed setting channel to governor function.

*When using an independent governor [ON]/[OFF] switch, connect the AUX([ON]/[OFF]) connector of the governor to Governor2 and set the switch to Governor2 at the Function menu of the Linkage Menu.

*When using the Fuel Mixture function, the mixture servo is controlled from the governor. When transmitting the mixture curve data from the transmitter to the governor, the governor AUX (m.trm) connector must be connected to Governor2 function and governor side setting performed. See the governor instruction manual.

Note: Always set (Act) and (Trim) to [NULL] for [Governor] and [Governor 2] of the Function menu. The subtrim of [Governor] is made 0%. Make the reverse direction normal.

- Touch the [Governor] button of the Model Menu to call the setup screen shown below.

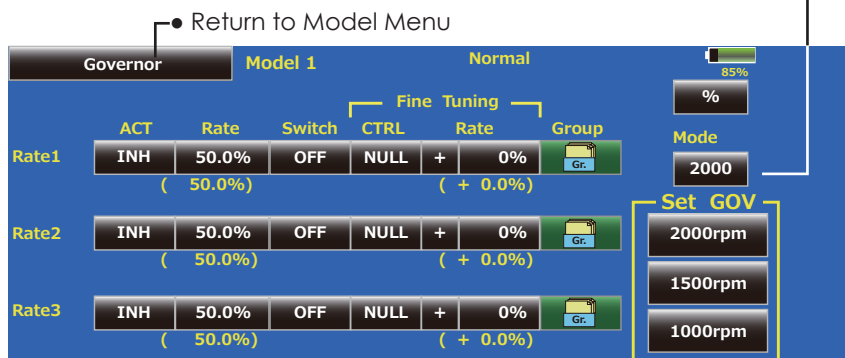

- When the "Mode" button on the Governor screen is pressed, the display mode is switched.

2000: 2000rpm mode

2500: 2500rpm mode.

- The 2500rpm mode and 2000rpm mode are different when the rate is 50.0% (=2500rpm) or greater. At rates below 50.0%, the rpm displays the same for both modes.

- When the 2500rpm mode is set, 100.0%=2500rpm. The maximum value is 110.0%=2700rpm.

- When the 2000rpm mode is set, 100.0%=200rpm. The maximum value is 110.0%=2100rpm. (Conventional specifications)

- There is no change in the transmitter output even when the 2500rpm mode and 2000rpm mode are switched. Calibration must be performed at the governor side.

Setting method

- Touch the [INH] button of the rate to be used and display [ON].
- **When you want to set the same settings to other conditions, select the group mode (Gr.). When you want to add settings to the selected condition only, select the single mode (Sngl).**
- Three speeds (rates) can be set for each condition. (Rate 1/Rate 2/Rate 3)
- End point initialization
The governor output channel end point(ATV) "travel" and "limit" are now initialized when the governor setting "Operate" button was pressed.
- When switched from INH to ON or OFF, "travel" is initialized to 100 and "limit" is initialized to 155.
- When "Operate" of rates 1, 2 and 3 is switched to INH under all conditions, "travel" is initialized to 100 and "limit" is initialized to 135.

Also, this mixing and the governor side speed setting must be matched beforehand by the following method:

- Set so that when the governor side is placed in the speed setting item state and [2000rpm] of Set GOV of the screen above is touched, the governor speed is set to "2000", when the [1500rpm] button is touched, the governor speed is set to "1500", and when the [1000rpm] button is touched, the governor speed is set to "1000".
- When you want to read the speed directly, press the [%] button and display [rpm].
- The speed can be watched by setting a switch. Also, when [OFF] is set instead of speed setting, the governor can be turned [ON]/[OFF] without setting a separate [ON]/[OFF] switch.
- A speed fine tuning VR can be set.

*VR selection, adjustment width, and adjustment direction can be set.

Throttle Limiter

This function limits the high range of the throttle movement by any slider or trimmer. The adjustment range of the high and low end can be set.

- Touch the [Throttle Limiter] button of the Model Menu to call the setup screen shown below.

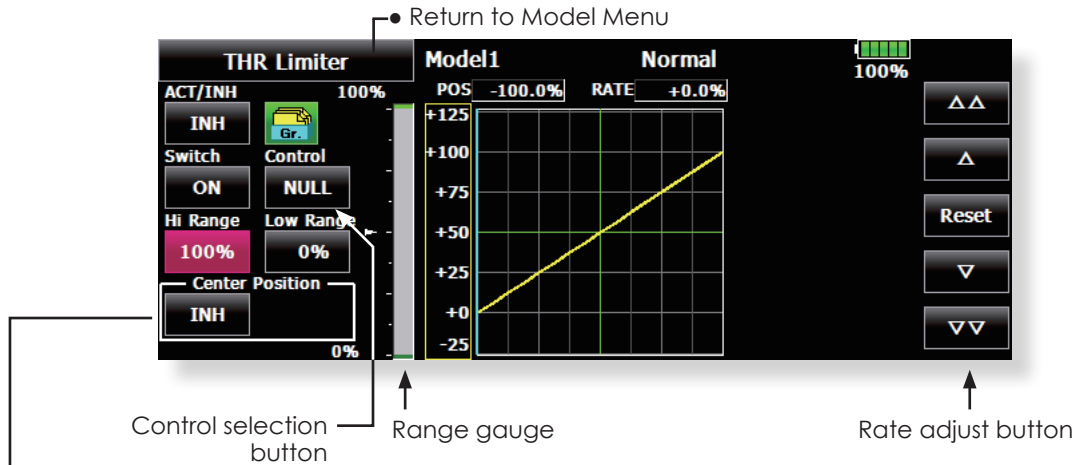

Setting method

- Activate the mixing and select the on/off switch.
- Select the control for adjustment of the high limit.
- Set the high range. The range gauge shows the setting position.
- Set the low range same as high range setting.

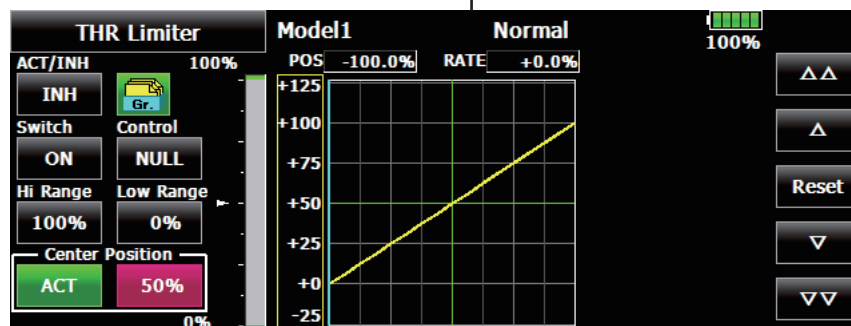

The limit value at the operation hardware neutral position can now be adjusted using the throttle limiter.

1. Set "Center position" on the throttle limiter screen to Operate.
2. When the "Center position" rate is changed, the limit value at the operation hardware neutral position can be adjusted.
 - The limit value at the operation hardware neutral position when "Center position" was changed to INH (at conventional operation) is the center value between "High side range" and "Low side range".
 - When "Center position" was switched from INH to Operate, the "Center position" rate is reset to the center value between "High side range" and "Low side range".
 - The "Center position" rate can be set between "High side range" and "Low side range".

COMMON OPERATIONS USED IN FUNCTION SETUP SCREEN

This section describes the functions often used at the function setup screen. Refer to it when setting each function.

Operations related to flight conditions

Group/single mode switching (Gr./Sngl)



When setting multiple flight conditions, linking the setting contents with other conditions (Gr.) or setting independently (Sngl) can be selected. When the button is touched, it toggles between Gr. and Sngl.

*Group mode (Gr.) (initial setting): The same setting contents are set to all the flight conditions in the group mode.

*Single mode (Sngl): Select this mode when the setting contents are not linked with other conditions.

*Selecting the single (Sngl) mode at each condition after presetting in the group mode (Gr.) is convenient.

Condition delay setting

Unnecessary fuselage motion generated when there are sudden changes in the servo position and variations in the operating time between channels at condition switching can be suppressed.

When the delay function is set at the switching destination condition, a delay corresponding to that amount is applied and the related functions change smoothly.

[Setting method]

1. Switch to the condition you want to set.
2. Touch the Delay button.
3. Use the adjustment buttons to set the delay.

*Initial value: 0

*Adjustment range: 0~27 (maximum delay)

Operations related to VR tuning

Fine tuning VR setting

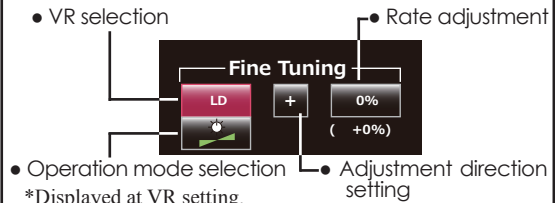

[Operation modes]



Mixing rate 0% at center of VR
When the VR is turned counterclockwise and clockwise, the mixing rate increases and decreases, respectively.



Mixing rate 0% at left end of VR
When the VR is turned, the mixing rate increases.



Mixing rate 0% at right end of VR.
When the VR is turned, the mixing rate increases.



When the VR is turned to the left or right of the neutral position, the mixing rate increases.

Operations related to servo speed

Servo speed setting (1)

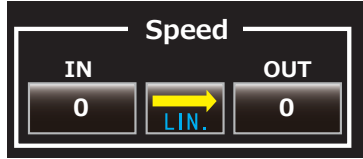

The speed during operation (including flight condition switching) can be adjusted. The servos operate smoothly at a constant speed corresponding to the speed set for them. The operation speed (In Speed) and the return speed (Out Speed) can be set individually.

Switch the operation mode according to the set function. When the button is touched, it toggles between [LIN] and [SYM].

"SYM" mode: Mode used with ailerons and other self-neutral functions

"LIN" mode: Mode used with functions which hold the operation position of the throttle and switch channel, etc.

[Setting method]

1. Select the function ([LIN] or [SYM]) matched to the master channel. Each time the button is touched, it toggles between [LIN] and [SYM].
2. Touch the In or Out Speed button and set the servo speed.

Initial value: 0

Setting range: 0~27

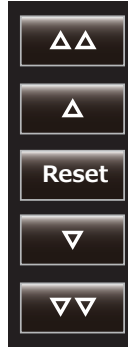

Servo speed setting (2) (Prog. Mix only)

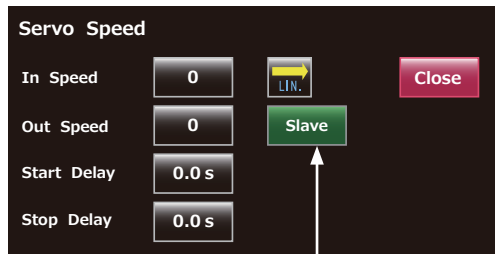

Speed mode: Slave/Master

The speed mode can be selected.

Slave mode: The speed at programmable mixing switching can be adjusted. The servos operate smoothly at a constant

speed corresponding to the set speed.

Master mode: The servo movement is traced by the setting curve. The trace speed is adjusted by in and out speed.

[Setting method]

1. When setting the servo speed, touch the Speed button. The Servo Speed setup screen shown above is displayed.
2. Select the function ([LIN] or [SYM]) matched to the master channel. Each time the button is touched, it toggles between [LIN] and [SYM].
"SYM" mode: Mode used with ailerons and other self-neutral functions.
"LIN" mode: Mode used with functions which hold the operating position of the throttle and switch channel, etc.
3. Touch the In Speed button and set the servo speed.
 Initial value: 0
 Setting range: 0~27
4. Touch the Out Speed button and set the servo speed.
 Initial setting: 0
 Setting range: 0~27
5. Touch the Start Delay button and set the delay time from switch ON to the start of function operation.
 Initial setting: 0.0 sec
 Setting range: 0~4 secs
6. Touch the Stop Delay button and set the delay time from switch OFF to the start of function operation.
 Initial setting: 0
 Setting range: 0~4 secs

At master mode;

1. Set desired in and out speed.
2. Select the master channel to any toggle switch.
3. The slave channel's servo traces the setting curve as the master toggle switch is moved. Below the case, AUX1 servo traces an EXP1 curve as the SW-F is operated.

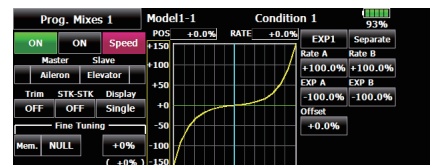

Curve setting operation

This section describes the setting procedure of curves which are used with the AFR function and each mixing function.

Curve type selection

When the curve type select button on the mixing function screen or other screen is touched, the setup screen shown below is called.

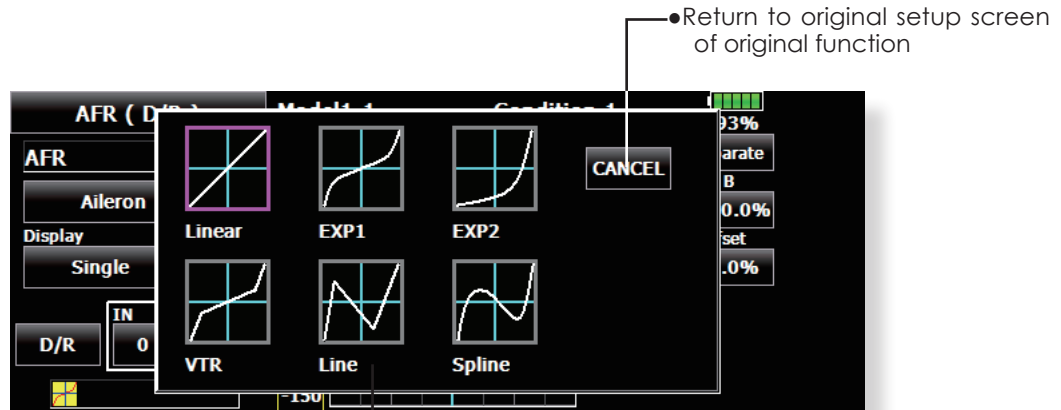

Curve type selection

1. Touch the button of the curve type you want to use.
*The curve type changes and the display returns to the original screen.

When curve type is changed:

The curve shape is inherited when the curve type is changed.

(Example: Changes from EXP1 to Line curve type.)

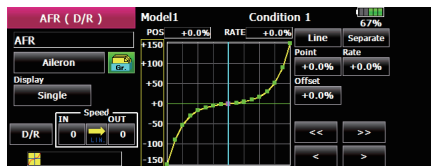
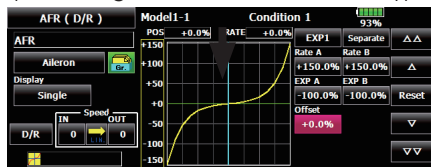

retrieved from the previous setting data when changing the curve type.

At the curve type changes, the dialogue box asks whether the current curve is reset or inherited. The default curve is used when selecting the Yes button on the confirmation dialogue.

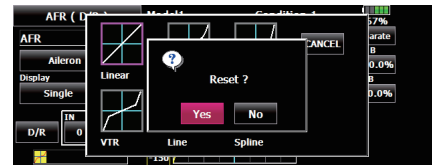

Changed to line or spline mode, the curve is retrieved as 17 points curve.

The Rate A and Rate B are inherited on the linear, EXP1, EXP2 and VTR.

Other data except Rate A and Rate B are

Setting by curve type

When the curve type is selected as described above, adjustment buttons corresponding to the curve type appear on the original screen. Adjust each curve as described below.

Linear curve adjustment

Rate A and Rate B can be adjusted separately or simultaneously.

[Setting modes]

***[Separate] mode:** Rates are adjusted separately.

***[Combined] mode:** Rates are adjusted simultaneously.

[Setting method]

1. Select the setting mode.
2. Touch the Rate A or Rate B button.
3. Use the adjustment buttons to set the rate.

*Initial value: +100.0%

*Adjustment range: -200.0~+200.0%

The curve can also be offset horizontally in the vertical direction and the rate reference point can be offset to the left or right.

[Offsetting the curve horizontally in the vertical direction]

1. Touch the Offset button.
2. Use the adjustment buttons to move the curve horizontally up and down.

*Initial value: +0.0%

[Offsetting the rate reference point to the left or right]

1. Touch the X Offset button.
2. Use the adjustment buttons to move the reference point to the left or right.

*Initial value: +0.0%

(Linear curve)

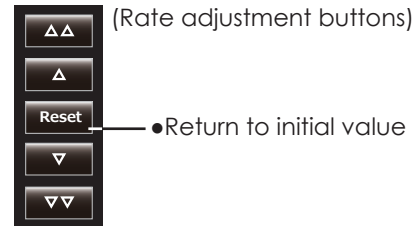
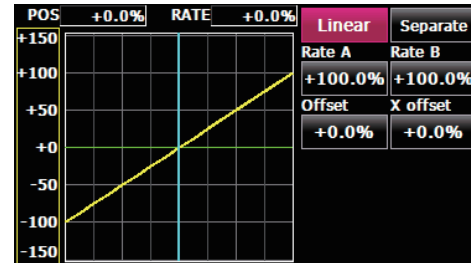

EXP1 curve adjustment

Rate A and Rate B can be adjusted separately or simultaneously. The EXP curves rate (EXP A, EXP B) can also be adjusted separately or simultaneously.

[Setting modes]

*[**Separate**] mode: Rates are adjusted separately.

*[**Combined**] mode: Rates are adjusted simultaneously.

[Setting method]

1. Select the setting mode.
2. Touch the button of the rate or EXP curve rate you want to set.
3. Use the adjustment buttons to set the rate.

*Initial value: +100.0% (rate), +0.0 (EXP rate)

The curve can also be horizontally offset in the vertical direction.

[Offsetting the curve horizontally in the vertical direction]

1. Touch the Offset button.
2. Use the adjustment buttons to move the curve horizontally up or down.

*Initial value: +0.0

VTR curve adjustment

Rate A and Rate B can be adjusted separately or simultaneously. The VTR curve point positions (P. Pos. A, P. Pos. B) and rates (P. Rate A, P. Rate B) can also be adjusted separately or simultaneously.

[Setting modes]

*[**Separate**] mode: Positions and rates are adjusted separately.

*[**Combined**] mode: Positions and rates are adjusted simultaneously.

[Setting method]

1. Select the setting mode.
2. Touch the button of the rate or VTR curve point position (or rate) you want to set.
3. Use the adjustment buttons to set the VTR curve point position (or rate).

*Initial values: +100.0% (Rate), -50.0% (P.Pos.A), +50.0% (P.Pos.B), +0.0% (P. Rate)

The curve can also be offset horizontally in the vertical direction.

[Offsetting the curve horizontally in the vertical direction]

1. Touch the Offset button.
2. Use the adjustment buttons to move the curve horizontally up and down with the adjustment buttons.

*Initial value: +0.0%

(EXP1 curve)



- Using the EXP1 curve is helpful in smoothening starting of the ailerons, elevators, rudder, etc.

(EXP2 curve)

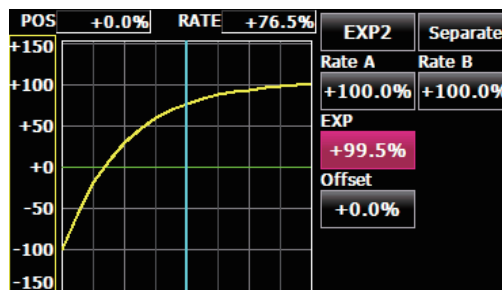

- Using the EXP2 curve is helpful in engine rise and other engine control.

(VTR curve)

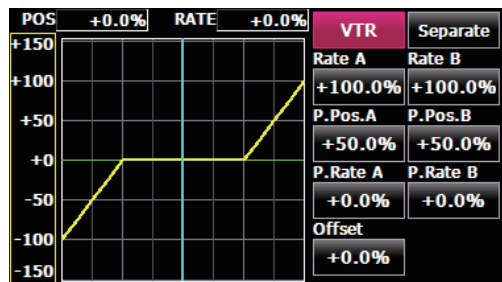

- Setting is fast if left, right, up, and down are first decided in the Combined mode and the mode is then switched to the Separate mode.

When this curve is used when the operating rudder angle is large such as with acrobatic models, switching from normal flight to acrobatic rudder angle is performed without switch operation.

Line and spline curve adjustment

Line curves or spline curves of up to 17 points can be used. (Initial value: 7/9 points) The set points can be freely increased, decreased, and offset. Curves which are symmetrical to the left and right of center can also be set.

[Setting modes]

***[Separate] mode:** Normal setting

***[Combined] mode:** Creates a left and right symmetrical curve.

[Adjusting the rate of each point]

1. Use the move between points buttons [<<] or [>>] to select the point. (The pink point is the selected point.)
2. Touch the Rate button.
3. Use the adjustment buttons to adjust the rate.

[Point addition method]

1. After touching the point button, move the stick, etc. to the point you want to add and press the [Move] button. (An outlined point appears on the graph.)

Or move the stick, etc. to the position you want to add and press the [Move] button. (An outlined point appears on the graph.)

2. Use the move buttons [<] or [>] to fine adjust the position.

3. Touch the Insert button.

*A new point is created.

[Point deletion]

1. Use the move between points button [<<] or [>>] and select the point. (The pink point is the selected point.)
2. Because [Rate] is pushed and [Delete] is displayed, touch the [Delete] button. (The selected point becomes an outlined point.)
3. Touch the move between point button [<<] or [>>].

*The point is deleted.

The curve can also be offset horizontally in the vertical direction.

[Offsetting the curve horizontally in the vertical direction]

1. Touch the Offset button.
2. Use the adjustment buttons to move the curve horizontally up and down.

*Initial value: +0.0%

(Line curve)

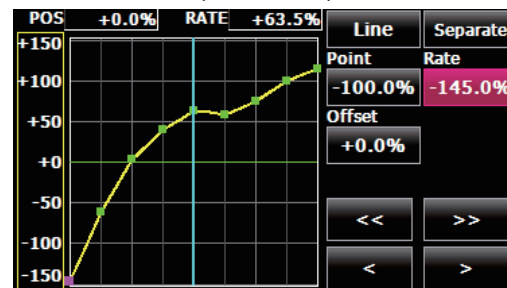

(Spline curve)

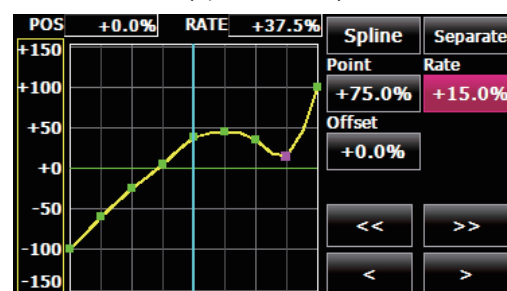

(Rate adjustment buttons)

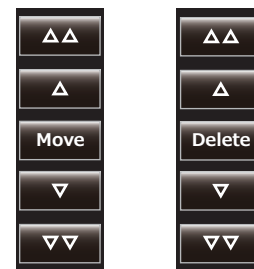

Switch selection method

The various functions used in the T18MZ can be selected by switch. The switch (including when stick, trim lever, or VR are used as a switch) setting method is common to all functions.

Switch mode selection (Single switch/Logic switch)

When the switch select button in a mixing function screen or other screen is touched, the switch mode selection screen shown below is called. Single mode or logic mode can be selected.

Logic switch

The Logic switch can activate functions by the use of other switch combinations. Up to 4 switch combinations can be set. The Logic switch can be assigned to the mixing function as well as the flight condition select (except for Snap roll function on airplane mode).

(Switch mode selection screen example)

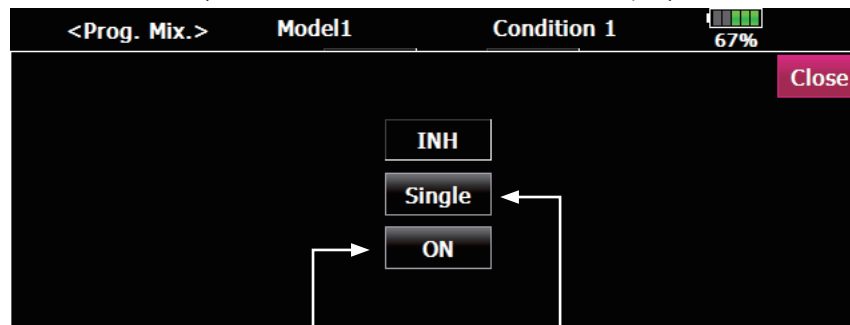

*In case of the flight condition select, the top of the switch on/off status display is not shown.

●Switch selection button

●Mode selection button

If using the single switch:

1. Push the switch selection button.

*The switch selection screen appears.

If using the logic switch:

1. The switch mode display is changed by pushing the mode selection button. And then push the [Yes] button.

*The logic mode setting screen appears.

*For a description of the logic mode setting method, see the section "Logic switch" below.

Logic switch

In the Logic screen, the switch selection buttons appear on both the left and right side of the display.

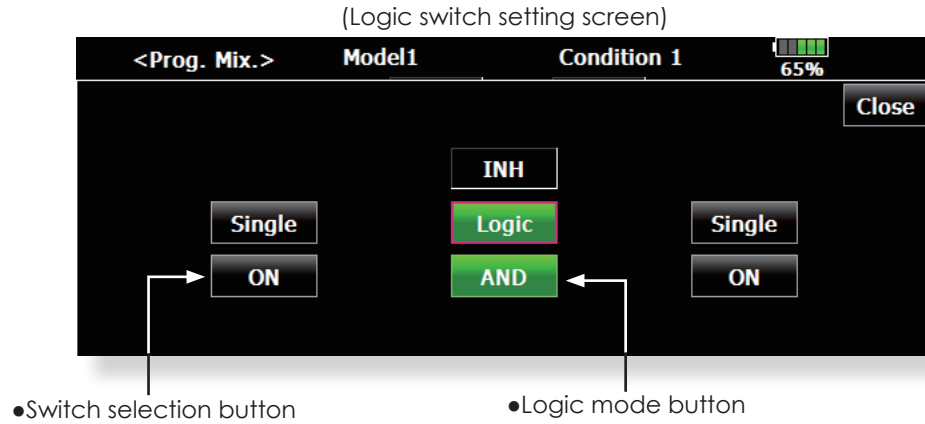

1. The logic selection dialogue appears when you push the logic mode button. The 3 types of logic, either AND, OR or EX-OR, can be selected.



Logic combination table:

SWITCH		LOGIC		
SW1	SW2	AND	OR	Ex-OR
off	off	off	off	off
off	on	off	on	on
on	off	off	on	on
on	on	on	on	off

2. The left and right side of the switch mode can be set to the logic switch mode as well. In this case, a maximum of 4 switches can be assigned to the logic switch. The left and right logic are calculated first, then the center of the logic is calculated. Finally, switch on/off status determined by the 4 switches' combination.

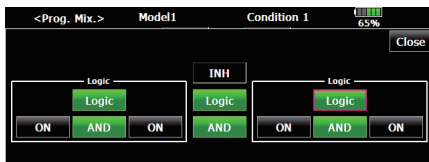

In the above case, the two switches in the left are calculated by AND logic. Next the

two switches in the right are calculated as same way. Finally the first case and 2nd case are calculated by OR logic.

Caution:

1. The maximum number of the logic switch is 10 for the flight condition select and 8 for the mixing on/off selection on each flight condition. The error message will appear when the exceeded logic switch is going to be selected. In this case, delete the unused logic switch first, then select the new logic switch.

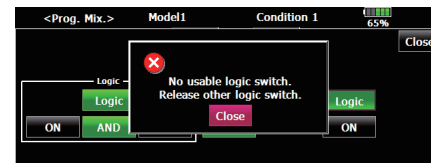

2. The mixing on/off switch modes are automatically assigned by single mode, not supported the group mode.

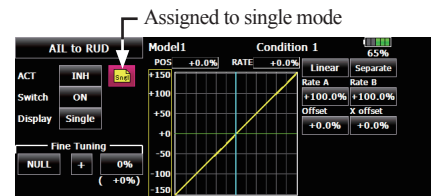

Switch selection

When the switch selection button in switch mode selection screen or the logic switch setting screen is touched, the screen below is shown.

(Switch selection screen example)

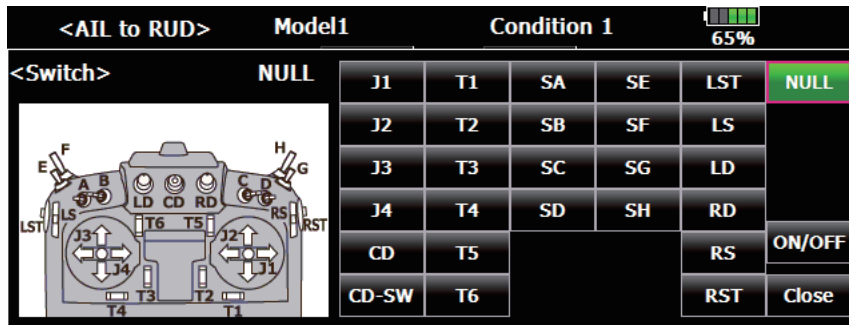

When switch is selected

Switch ON/OFF setting is possible at each position.

- **Alternate:** Alternate switching mode is available depending on mixing function.

1. When the ON position switch is touched after the switch was selected, the screen shown below appears.

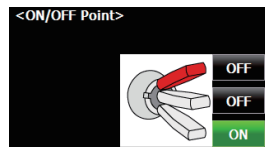

- *When the button of each position is touched, it toggles between ON and OFF.
2. Touch the button and set to the ON position.
 3. Close the screen by touching [Close].

When stick, trim lever, or VR is selected.

When a stick, trim lever, or VR is used as a switch, the following 4 modes can be selected.

- **Mode:** Lin/Sym
- **Type:** Hysteresis (Hys.)/box (Box)

1. When the ON position button is touched after stick, etc. was selected, the screen shown below appears.

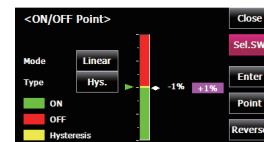

2. Select the mode you want to use, and set it as described below.
3. Close the screen by touching [Close].

Operation modes

The operation modes when stick, trim lever or VR are selected are described below. Change the operation mode by touching the Mode and Type buttons.

Linear hysteresis mode

This setting method selects function ON/OFF based on the set point. Hysteresis (dead band) can be set between ON and OFF. The ON and OFF positions can be reversed with the Reverse button.

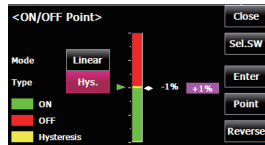

Symmetrical hysteresis mode

Operation is the same as the linear hysteresis mode, but left and right (up and down) operations are symmetrical about the neutral position. For example, when you want to switch DR1 with the aileron stick, when the stick is moved to the left or right, DR1 can be turned ON at the same left and right position.

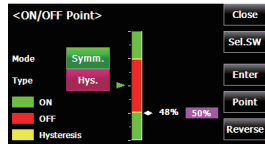

Linear box mode

This mode turns on the switch within a range of 2 points. Each point can be set. The ON and OFF positions can be reversed with the Reverse switch.

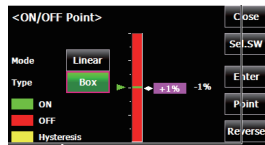

Symmetrical box mode

Operation is the same as the linear box mode, but left and right (up and down) operation is symmetrical about the neutral position.

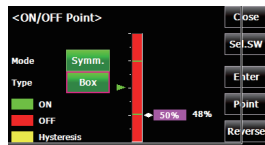

When shifting the ON/OFF point

The ON/OFF and hysteresis (dead band) boundary point (there are 2 points: top and bottom) position can be shifted. ON/OFF is possible at a free position.

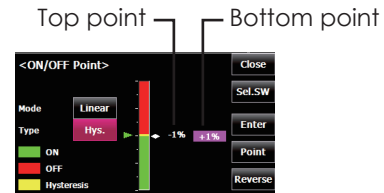

[Setting method]

1. Select the top and bottom boundary points with the [Point] button.
2. Move the stick, etc. to the point you want to shift and touch the [Enter] button. The boundary points change.

*Also shift other points, as required.

UPDATING

Your Futaba T18MZ transmitter programming can be updated easily and at no cost online. When functions are added or improved, the update file can be downloaded from our website. Copy the update files to the SD card and then use the following procedure to update the program.

Check our web site for the FAQ regarding updating for more information.

Updating procedure

Note: If the battery fully discharges during program updating, updating will fail. When the remaining battery capacity is 50% or less, always recharge the battery before updating.

Note: The model data in the transmitter can be used unchanged after updating, but to be safe, back up the model data before updating.

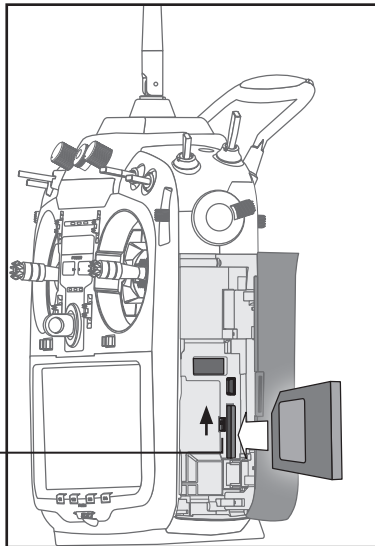

1. Insert the SD card containing the update file into the card slot.
2. Use tweezers to switch the slide switch (update switch) at the side of the card slot in the up direction.
3. Turn on the transmitter power. An update screen is displayed. Rotary key or the arbitrary direct keys are pressed.

T18MZ SOFTWARE UPDATE

Push the edit dial or any direct key to start the update.

4. When updating is complete, the screen shown below appears.

T18MZ SOFTWARE UPDATE

The update of the main program.
Now Writing.



T18MZ SOFTWARE UPDATE

The update of the language pack.
Now Writing.



T18MZ SOFTWARE UPDATE

The sub program update.
Now Writing.



T18MZ SOFTWARE UPDATE

The update has been completed.
Please turn off the power switch.



5. Turn off the power switch. After the monitor LED goes off, switch the update switch in the down direction.

If a problem occurs, an error message will appear and the update will not be complete.

After the updating above has been completed, turn on the power and then check the system program version at the system menu information screen.

T14MZ → T18MZ MODEL DATA CONVERSION

The model data (only latest version) of T14MZ can be copied to T18MZ.

* The card reader of a personal computer, SD card, and CF card is required.

* The model data of T18MZ cannot be copied to T14MZ.

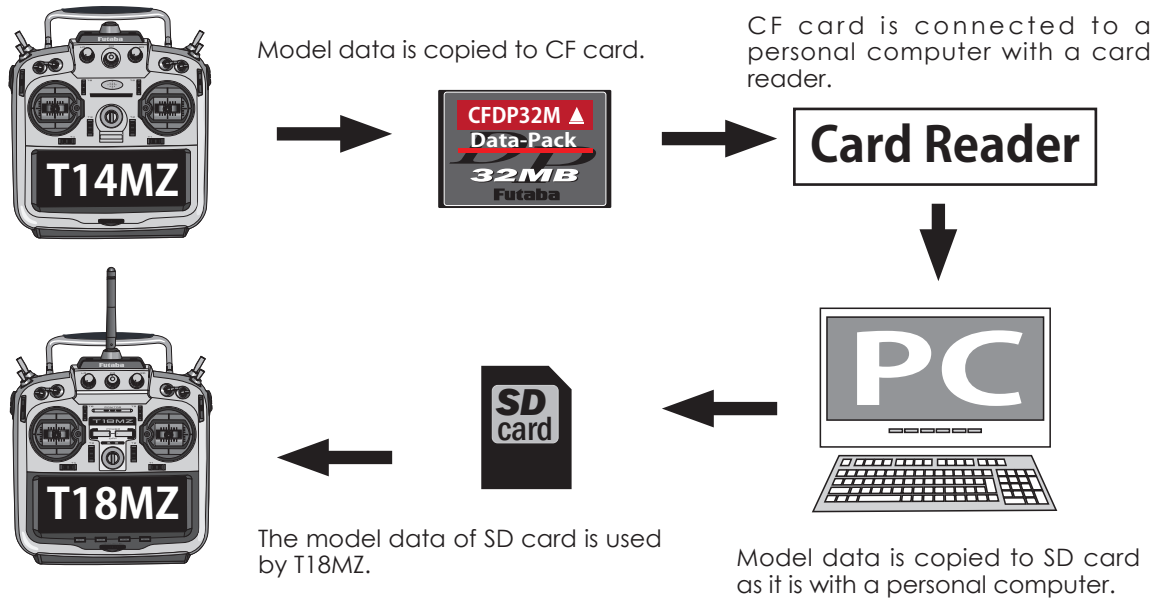

[Model data conversion method]

1. The data which T14MZ wants to copy is put into CF card.
2. The card reader of option marketing is connected to the personal computer of a stock, and CF card is inserted in a card reader.
3. SD card is connected to the personal computer.
4. With the personal computer, the model data of CF card is copied to SD card.
5. The SD card is inserted in T18MZ, and it copies to T18MZ from SD card by the [Linkage menu] and [Model select].

* When SD card cannot be recognized, it may be able to be used if it reformats by SD formatter offered from SD Association.

SD formatter is downloadable from SD Association (<https://www.sdcard.org/>).

(As of December, 2011)

⚠ Caution

❗ After the completion of a data copy should fully perform a check of operation on the model to be used .

❗ Check well all the directions of operation and all the operation switches.



FUTABA CORPORATION

1080 Yabutsuka, Chosei-mura, Chosei-gun, Chiba-ken, 299-4395, Japan

Phone: +81 475 32 6982, Facsimile: +81 475 32 6983